



High Precision Collet Chuck System

# MEGA ER GRIP<sup>®</sup>

**NEW**

**BIG DAISHOWA SEIKI CO LTD**

CATALOG No. **EXi166**

Enhanced high precision collet system  
outperforms conventional ER collet chucks

***Incredibly low runout will provide dramatic payback by improving machining capability and reducing production costs.***



- Economical
- Power saving
- Reduced cycle time
- Extended tool life

BIG Daishowa supports your "ECO" manufacturing.

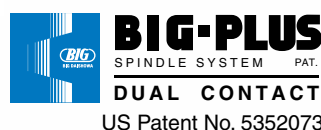

**BIG-PLUS<sup>®</sup> tools can be used in machining centers with conventional spindles.**

***The total precision of our collet, nut, and body shatter the common standard of ER collet chucks***



**MEGA ER GRIP**<sup>®</sup>

BIG Daishowa Seiki, known as a world leader in tooling systems, has observed and visited many companies of various size for many years. We have learned from those experiences how the choice of tool holders affects production costs on the shop floor. When an inexpensive tool holder is selected based on a small cost saving, a waste in valuable time and money during production results in higher costs in the long term.

The four critical requirements for tool holders are:

- Clamping force
- Concentricity
- Rigidity
- Balance for high spindle speeds

By using a tool holder with excellent performance in these four areas, considerable cost reduction is achieved due to longer tool life and reduction of down-time due to tool changes. Also, improvements in machining quality, shorter production time, and longer machine tool life from less cutting vibration.

Below is an application for drilling into a steel work piece .590" deep using a .118" diameter carbide drill. 2,300 holes are made with the drill when using a tool holder with .00008" runout accuracy. However, only 800 holes can be drilled with a tool holder that has .0006" runout accuracy.

Comparing these hole-making costs at a shop that drills 350 holes per day for 20 working days per month, it is possible to save about \$280 each month.

	Runout Accuracy	
	.00008"	.0006"
Number of holes drilled	350 holes/day	
Number of working days	20 days/month	
Tool life (holes)	2,300	800
Number of tool changes	3.0	8.8
Unit price of tools	\$35.00	
Tool expenses	\$105.00	\$308.00
Time for replacing a tool	10 minutes	
Machine charge	\$80.00/hr	
Expenses for replacing a tool	\$40.00	\$117.33
Total cost	\$145.00	\$425.33
Cost difference	\$280.33	



# The cost performance of tool holders after introduction to the shop floor.



BIG's Mega ER Grip is a high quality ER collet chuck that completely satisfies the 4 requirements for tool holders. Each part of the assembly puts together our high precision production technology and our design creativity for collets, clamping nuts and chuck bodies. The ER collet with a 16° taper was developed in 1960. In 1993 it was adopted as a German DIN standard and in 2003 into an ISO standard. As a result, it has achieved status as the most popular double taper collet world-wide. When it was first introduced to the market 50 years ago, high quality and high performance was measured at a different level due to the common use of high speed steel tools.

In modern times, however, high quality is essential for the latest cutting tools such as coated carbide tools, CBN, PCD, etc.



Compare the test results of runout accuracy between BIG's Mega ER Grip and a common ER supplier. The test consists of measuring the runout accuracy at 1.968" length on a  $\phi.394$ " test bar clamped with an ER16 collet. Only BIG's Mega ER Grip can successfully maintain stable accuracy.

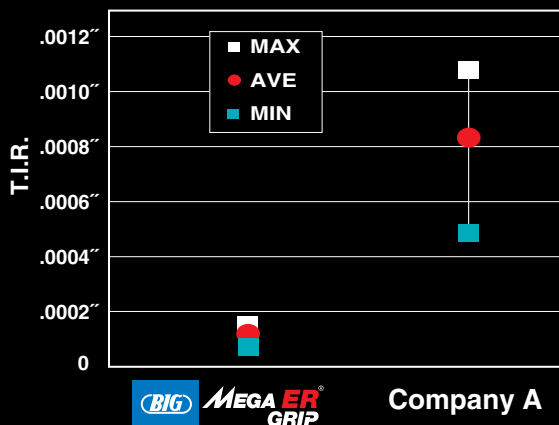
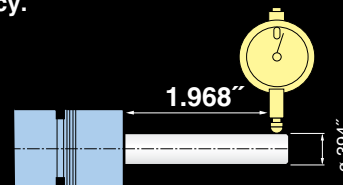

Every manufacturer needs to recognize all of the challenges and find solutions that will help them in maintaining a competitive edge.

Usually there are many simple and economical solutions to minimize down-time and to run their machining operations effectively and efficiently.

Our challenge is to recognize issues that waste time and to use a solution that will reward us with profit.

We believe that BIG's Mega ER Grip contributes to your company's cost saving without any doubts.



To maintain the accuracy of the product, do not mix collets and nuts manufactured by other companies with the body of BIG's Mega ER Grip. Also, it is not possible to reach the original accuracy if collets and nuts manufactured by BIG are used with other conventional ER chuck bodies.

High precision collet, nut and body that outperforms standard ER systems.

Reliable and stable runout accuracy will also tremendously contribute to improving machining capability and cost reduction.



High precision collet chuck system  
Clamping Range:  $\phi.075'' - \phi.787''$

**MEGA ER GRIP**<sup>®</sup>

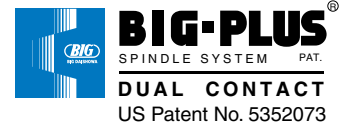

BIG Daishowa supports your "ECO" manufacturing.

- Economical
- Power saving
- Reduced cycle time
- Extended tool life



To maintain the accuracy of the system, do not use collets or nuts produced by another company with the chuck body of BIG's Mega ER Grip. Also, it is not possible to reach the original accuracy if collets and nuts made by BIG are used with other conventional chuck bodies.

**ERC Collet**

The ERC collet with the best runout accuracy in the world

Measurement standards:  
In accordance with  
DIN6499 and ISO15488

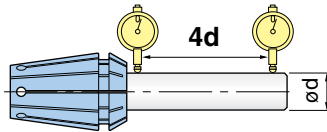

Clamping Range	DIN / ISO		BIG DAISHOWA <b>MEGA ER</b> <sup>®</sup>
	Class 1	Class 2	
$\phi.079'' - \phi.394''$	.00039"	.00059"	Within <b>.00012''</b>
$\phi.394'' - \phi.787''$	.00059"	.00079"	

All collets are inspected twice to guarantee the runout accuracy



In 1987, BIG was the first company in the world to laser mark the collet grade on every collet

Each ERC collet is inspected twice (0° and 180°) at 5 times diameter to guarantee the runout accuracy. The "AA grade" is marked on only those collets that pass the inspection process for accuracy.



The test bar clamped by Mega ER Grip is measured at 5xd.

BIG's Mega ER Grip can provide repeatable performance by assembling the precision ERC collets with its chuck body and clamping nut, resulting in complete harmony of the tool holder assembly.

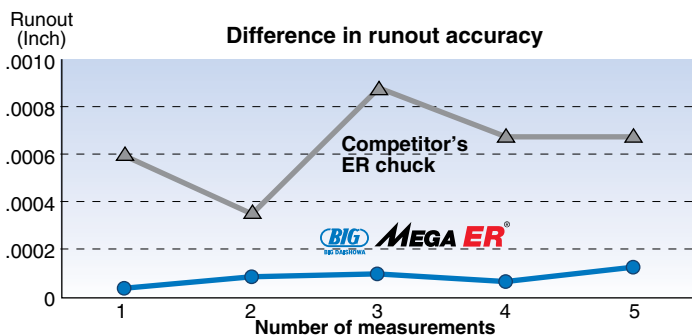
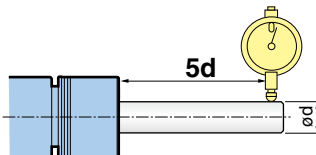

# Clamping Nut

## High precision nut with built-in thrust ball bearing

The ball bearing tapered raceway inside the nut eliminates any torsion where the collet and nut makes contact. This results in a smooth and stable collapse of the collet around the tool and provides for high accuracy and clamping force. Additionally, the slot-free outer diameter increases the rigidity of the nut itself and also prevents vibrations at high speeds.

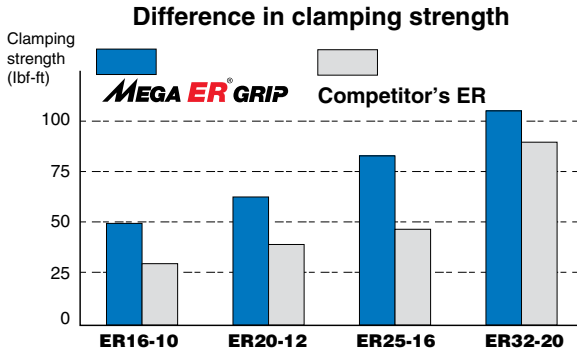
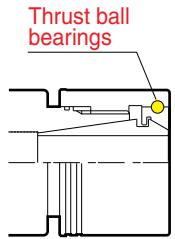

## Simplification of the nut tightening operation with the Mega Wrench PAT.

The one-way clutch of the Mega Wrench tightens the nut firmly and securely by applying even torque to the outside periphery of nut.

The ratchet function greatly helps to simplify and speed up the tightening operation of the nut and prevents injury to the hands of the operator.



## Precise coolant supply to the cutting edge (Perfect Seal) PAT.

MAX. COOLANT PRESSURE  
**1,000 PSI**

Mega ER Perfect Seal is available for 2 ways of coolant supply: With "Through Tools", coolant is supplied from the coolant holes of the cutter (such as drills) and "Jet Through" directs the coolant around the cutter periphery (such as end mills). Both methods can be adapted with the same Perfect Seal nut according to the desired use.

US Patent No. 5975817



Sealed nut for center through tools  
**[MEGA ER PERFECT SEAL]**  
Nut for jet through tools  
**[MEGA ER PERFECT JET]**

## High rigidity body that increases the contact area of the collet

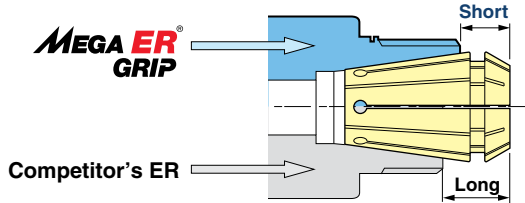

By increasing the contact length of the internal taper of chuck bodies, the undesired overhang of the collet is reduced. This modification of the standard improves 3 of the most important requirements for the collet chuck (rigidity, runout accuracy, clamping force). (Conventional DIN collets can also be used.)

## High precision pre-balanced body

The unbalance of the drive keys in the steep taper and HSK tool shanks is reduced to a minimum by a pre-balancing operation. (Capto® tool shanks are also pre-balanced) The tool shanks also include tapped holes around the periphery so that precision balancing can be performed with balancing screws.

## The serial number is marked on each body

## BIG's dual contact "BIG-PLUS"® as standard

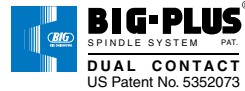

All steep taper shanks are produced in accordance with the BIG-PLUS® dual contact system for taper and flange contact for the possibility to obtain much better performance. BIG-PLUS® has obtained world-wide patents in 1992 and it is now adopted by most major machine builders world-wide. HSK and Capto® standards are also available. Chuck bodies with a wide assortment of projections are available for ER Grip to answer your application problems and maintain optimum tool length.

### Manufacturers adopting BIG-PLUS®

Machine builders **114** Licensed tool holder manufacturers **7**  
[As of February, 2010]

BIG-PLUS® is a registered trademark of BIG Daishowa Seiki.



BIG-PLUS®  
BVCV40/50



HSK-A63/100



C4/C5/C6/C8

## The runout accuracy greatly affects the tool life

The runout accuracy has a great influence on the tool life. The tool life achieved with Mega ER Grip is about 3 times the tool life obtained with conventional ER chucks.

Competitor's ER

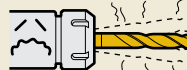

Runout of .0006"

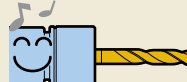

Runout within .000079"

**800 holes**

ø3mm carbide drill  
1040 steel  
12mm depth of cut

**2,300 holes**



# ERC Collet



All collets are inspected twice to guarantee the runout accuracy of "AA" quality

In 1987, BIG was the first company in the world to laser mark the collet grade on every collet

Each ERC collet is inspected twice (0° and 180°) at 5 times diameter to guarantee the runout accuracy. The "AA grade" is marked on only those collets that pass the inspection process for accuracy.

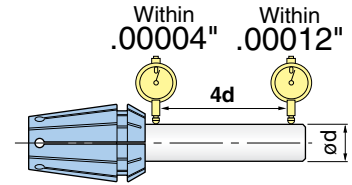
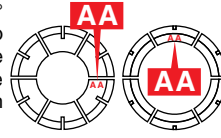

## Collet Concentricity

Collet Class	Max. Runout	
	At nose	At end of test bar
AA	Within <b>.00004"</b>	Within <b>.00012"</b>

DIN6499 ISO15488

MEGA ER16	
Model	Recommended Clamping Range $\phi d$
ERC16-2AA	.075 - .079
-2.1AA	.079 - .083
-2.2AA	.083 - .087
-2.3AA	.087 - .091
-2.4AA	.091 - .094
-2.5AA	.094 - .098
-2.6AA	.098 - .102
-2.7AA	.102 - .106
-2.8AA	.106 - .110
-2.9AA	.110 - .114
-3AA	.108 - .118
-3.25AA	.118 - .128
-3.5AA	.128 - .138
-3.75AA	.138 - .148
-4AA	.148 - .157
-4.25AA	.157 - .167
-4.5AA	.167 - .177
-4.75AA	.177 - .187
-5AA	.187 - .197
-5.25AA	.197 - .207
-5.5AA	.207 - .217
-5.75AA	.217 - .226
-6AA	.217 - .236
-6.5AA	.236 - .256
-7AA	.256 - .276
-7.5AA	.276 - .295
-8AA	.295 - .315
-8.5AA	.315 - .335
-9AA	.335 - .354
-9.5AA	.354 - .374
-10AA	.374 - .394

$\phi A = .630$  B = 1.083 L = .246

MEGA ER20	
Model	Recommended Clamping Range $\phi d$
ERC20-3AA	.108 - .118
-3.25AA	.118 - .128
-3.5AA	.128 - .138
-3.75AA	.138 - .148
-4AA	.148 - .157
-4.25AA	.157 - .167
-4.5AA	.167 - .177
-4.75AA	.177 - .187
-5AA	.187 - .197
-5.25AA	.197 - .207
-5.5AA	.207 - .217
-5.75AA	.217 - .226
-6AA	.217 - .236
-6.5AA	.236 - .256
-7AA	.256 - .276
-7.5AA	.276 - .295
-8AA	.295 - .315
-8.5AA	.315 - .335
-9AA	.335 - .354
-9.5AA	.354 - .374
-10AA	.374 - .394
-10.5AA	.394 - .413
-11AA	.413 - .433
-11.5AA	.433 - .453
-12AA	.453 - .472
-12.5AA	.472 - .492
-13AA	.492 - .512

$\phi A = .787$  B = 1.240 L = .250

MEGA ER25	
Model	Recommended Clamping Range $\phi d$
ERC25-3AA	.108 - .118
-3.25AA	.118 - .128
-3.5AA	.128 - .138
-3.75AA	.138 - .148
-4AA	.148 - .157
-4.25AA	.157 - .167
-4.5AA	.167 - .177
-4.75AA	.177 - .187
-5AA	.187 - .197
-5.25AA	.197 - .207
-5.5AA	.207 - .217
-5.75AA	.217 - .226
-6AA	.217 - .236
-6.5AA	.236 - .256
-7AA	.256 - .276
-7.5AA	.276 - .295
-8AA	.295 - .315
-8.5AA	.315 - .335
-9AA	.335 - .354
-9.5AA	.354 - .374
-10AA	.374 - .394
-10.5AA	.394 - .413
-11AA	.413 - .433
-11.5AA	.433 - .453
-12AA	.453 - .472
-12.5AA	.472 - .492
-13AA	.492 - .512
-13.5AA	.512 - .531
-14AA	.531 - .551
-14.5AA	.551 - .571
-15AA	.571 - .591
-15.5AA	.591 - .610
-16AA	.610 - .630

$\phi A = .984$  B = 1.339 L = .262

MEGA ER32	
Model	Recommended Clamping Range $\phi d$
ERC32-3AA	.108 - .118
-3.25AA	.118 - .128
-3.5AA	.128 - .138
-3.75AA	.138 - .148
-4AA	.148 - .157
-4.25AA	.157 - .167
-4.5AA	.167 - .177
-4.75AA	.177 - .187
-5AA	.187 - .197
-5.25AA	.197 - .207
-5.5AA	.207 - .217
-5.75AA	.217 - .226
-6AA	.217 - .236
-6.5AA	.236 - .256
-7AA	.256 - .276
-7.5AA	.276 - .295
-8AA	.295 - .315
-8.5AA	.315 - .335
-9AA	.335 - .354
-9.5AA	.354 - .374
-10AA	.374 - .394
-10.5AA	.394 - .413
-11AA	.413 - .433
-11.5AA	.433 - .453
-12AA	.453 - .472
-12.5AA	.472 - .492
-13AA	.492 - .512
-13.5AA	.512 - .531
-14AA	.531 - .551
-14.5AA	.551 - .571
-15AA	.571 - .591
-15.5AA	.591 - .610
-16AA	.610 - .630
-16.5AA	.630 - .650
-17AA	.650 - .670
-17.5AA	.670 - .690
-18AA	.690 - .709
-18.5AA	.709 - .728
-19AA	.728 - .748
-19.5AA	.748 - .768
-20AA	.768 - .787

$\phi A = 1.260$  B = 1.575 L = .282

Conforms to  
DIN6499 and ISO15488

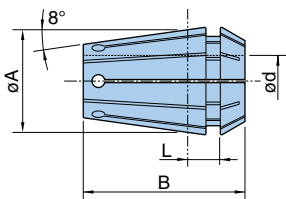

BIG's ERC collets of BIG have a maximum clamping capacity of 0.5mm/ $\phi$  (.020"/ $\phi$ ). To obtain the best runout accuracy and rigidity, ERC collets for smaller tools have a reduced clamping range. For best results, users should avoid clamping tools with shank diameters less than the recommended clamping range.



Conventional DIN collets have a clamping range of 1mm/ $\phi$ . Never use ERC collets for more than 0.5mm/ $\phi$  below nominal size. See page 16 for more information regarding compatibility.



To maintain the accuracy of the tool assembly, do not use collets and nuts manufactured by another company with the chuck body of BIG's Mega ER Grip. Also, we cannot guarantee the accuracy statement for our collets if they are assembled on the chuck body of another manufacturer.

## ERC COLLET FOR END MILLS

### "Just fit" collet for end mills

Nominal sizes of collets for the most popular end mill shanks reduces the unsupported overhang of the collet when clamped into the chuck body. This increases the rigidity of the tool assembly in the horizontal direction which is very important to end milling operations. Available in both metric and inch sizes.

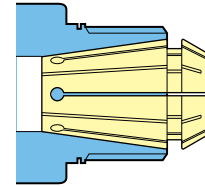

Conform to DIN6499 and ISO15488

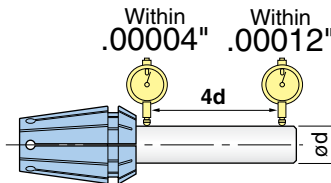
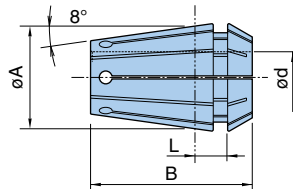

#### Collet Concentricity

Collet Class	Max. Runout	
	At nose	At end of test bar
AA	Within <b>.00004"</b>	Within <b>.00012"</b>

#### Inch

MEGA ER16	
Model	ød
ERC16-1/8EAA	.125
-3/16EAA	.188
-1/4EAA	.250
-5/16EAA	.312
-3/8EAA	.375

øA= .630 B= 1.083 L= .161

MEGA ER20	
Model	ød
ERC20-1/8EAA	.125
-3/16EAA	.188
-1/4EAA	.250
-5/16EAA	.312
-3/8EAA	.375
-7/16EAA	.438
-1/2EAA	.500

øA= .787 B= 1.240 L= .165

MEGA ER25	
Model	ød
ERC25-1/8EAA	.125
-3/16EAA	.188
-1/4EAA	.250
-5/16EAA	.312
-3/8EAA	.375
-7/16EAA	.438
-1/2EAA	.500
-9/16EAA	.563
-5/8EAA	.625

øA= .984 B= 1.339 L= .169

MEGA ER32	
Model	ød
ERC25-1/8EAA	.125
-3/16EAA	.188
-1/4EAA	.250
-5/16EAA	.312
-3/8EAA	.375
-7/16EAA	.438
-1/2EAA	.500
-9/16EAA	.563
-5/8EAA	.625
-3/4EAA	.750

øA= 1.260 B= 1.575 L= .176

#### Metric

MEGA ER16	
Model	ød (mm)
ERC16-3EAA	3
-4EAA	4
-5EAA	5
-6EAA	6
-7EAA	7
-8EAA	8
-9EAA	9
-10EAA	10

øA= .630 B= 1.083 L= .161

MEGA ER20	
Model	ød (mm)
ERC20-3EAA	3
-4EAA	4
-5EAA	5
-6EAA	6
-7EAA	7
-8EAA	8
-9EAA	9
-10EAA	10
-11EAA	11
-12EAA	12

øA= .787 B= 1.240 L= .165

MEGA ER25	
Model	ød (mm)
ERC25-3EAA	3
-4EAA	4
-5EAA	5
-6EAA	6
-7EAA	7
-8EAA	8
-9EAA	9
-10EAA	10
-11EAA	11
-12EAA	12
-13EAA	13
-14EAA	14
-15EAA	15
-16EAA	16

øA= .984 B= 1.339 L= .169

MEGA ER32	
Model	ød (mm)
ERC32-3EAA	3
-4EAA	4
-5EAA	5
-6EAA	6
-7EAA	7
-8EAA	8
-9EAA	9
-10EAA	10
-11EAA	11
-12EAA	12
-13EAA	13
-14EAA	14
-15EAA	15
-16EAA	16
-18EAA	18
-20EAA	20

øA= 1.260 B= 1.575 L= .176

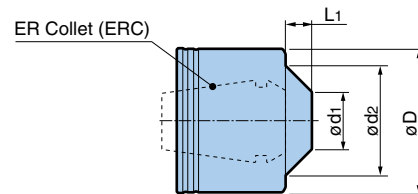

## MEGA ER PERFECT SEAL

Sealed collet nut for coolant-through tools.

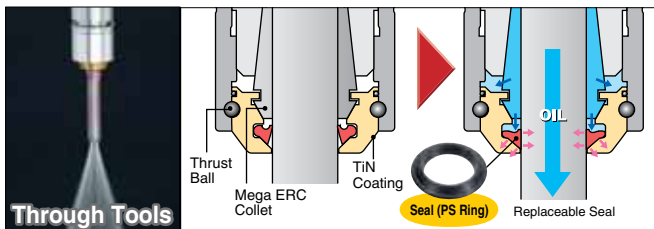

Through Tools

## MEGA ER PERFECT JET

Nut for coolant delivery around cutter shank periphery.

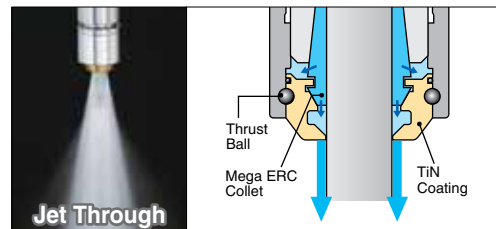

Jet Through

Mega ER Perfect Seal Model	Mega ER Perfect Jet Model	øD	ød1	ød2	L1	Cutter Shank Dia.	Collet Model (Inch)	Collet Model (Metric)
<b>MERPS16-030035</b>	<b>MERPSL16-030035</b>	1.181	.472	.882	.252	.118 - .138	ERC16-1/8E	ERC16-3 - 3.75
-035040	-035040					.138 - .157		-3.5 - 4.25
-040045	-040045		.157 - .177				-4 - 4.75	
-045050	-045050		.177 - .197			-3/16E	-4.5 - 5.25	
-050055	-050055		.197 - .217				-5 - 6	
-055060	-055060		.217 - .236				-5.5 - 6.5	
-060065	-060065		.591		.268	.236 - .256	-1/4E	-6 - 7
-065070	-065070					.256 - .276		-6.5 - 7.5
-070075	-070075		.276 - .295			-7 - 8		
-075080	-075080		.295 - .315		-5/16E	-7.5 - 8.5		
-080085	-080085		.630		.240	.315 - .335		-8 - 9
-085090	-085090					.335 - .354		-8.5 - 9.5
-090095	-090095		.354 - .375		-3/8E	-9 - 10		
-095100	-095100		.374 - .394			-9.5 - 10.5		
<b>MERPS20-030035</b>	<b>MERPSL20-030035</b>	1.378	.472	1.055	.252	.118 - .138	ERC20-1/8E	ERC20-3 - 3.75
-035040	-035040					.138 - .157		-3.5 - 4.25
-040045	-040045		.157 - .177				-4 - 4.75	
-045050	-045050		.177 - .197			-3/16E	-4.5 - 5.25	
-050055	-050055		.197 - .217				-5 - 6	
-055060	-055060		.217 - .236				-5.5 - 6.5	
-060065	-060065		.591		.268	.236 - .256	-1/4E	-6 - 7
-065070	-065070					.256 - .276		-6.5 - 7.5
-070075	-070075		.276 - .295			-7 - 8		
-075080	-075080		.295 - .315		-5/16E	-7.5 - 8.5		
-080085	-080085		.630		.272	.315 - .335		-8 - 9
-085090	-085090					.335 - .354		-8.5 - 9.5
-090095	-090095		.354 - .375		-3/8E	-9 - 10		
-095100	-095100		.374 - .394			-9.5 - 10.5		
-100105	-100105		.748		.260	.394 - .413		-10 - 11
-105110	-105110					.413 - .433		-10.5 - 11.5
-110115	-110115		.433 - .453		-7/16E	-11 - 12		
-115120	-115120		.453 - .472			-11.5 - 12.5		
-120125	-120125		.472 - .492			-12 - 13		
-125130	-125130		.492 - .512		-1/2E	-12.5 - 13		

### For Mega ER Perfect Seal (MERPS)

1. 1 pc. of PS Ring is included.

### For Mega ER Perfect Jet (MERPS)

- Back up screws cannot be used in conjunction with jet through coolant.
- To select the best size of Mega ER Perfect Jet nuts with jet through coolant, the desired pressure and/or flow rate of coolant supply around the periphery of the cutter shank should be considered.
  - For higher pressure, select the Mega ER Perfect Jet that accepts the largest applicable cutter shank diameter.
  - For higher flow rate or volume, a larger gap between the cutter shank diameter and Mega ER Perfect Jet should be selected within the applicable range of collet size. Please choose the size considering the rate of coolant flow desired.

Mega ER Perfect Seal Model	Mega ER Perfect Jet Model	øD	ød1	ød2	L1	Cutter Shank Dia.	Collet Model (Inch)	Collet Model (Metric)
MERPS25-030035	MERPSL25-030035	1.654	.472	1.319	.248	.118 - .138	ERC25-1/8E	ERC25-3 - 3.75
-035040	-035040		.512			.138 - .157		-3.5 - 4.25
-040045	-040045					.551	.157 - .177	-4 - 4.75
-045050	-045050		.591				.177 - .197	-3/16E
-050055	-050055					.630	.197 - .217	-5 - 6
-055060	-055060		.669				.217 - .236	-5.5 - 6.5
-060065	-060065				.709	.236 - .256	-1/4E	-6 - 7
-065070	-065070		.748			.256 - .276	-6.5 - 7.5	
-070075	-070075				.787	.276 - .295	-7 - 8	
-075080	-075080		.827			.295 - .315	-5/16E	-7.5 - 8.5
-080085	-080085				.866	.315 - .335	-8 - 9	
-085090	-085090		.906			.335 - .354	-8.5 - 9.5	
-090095	-090095				.945	.354 - .375	-3/8E	-9 - 10
-095100	-095100		.984			.374 - .394	-9.5 - 10.5	
-100105	---				1.024	.394 - .413	-10 - 11	
-105110	---		1.063			.413 - .433	-10.5 - 11.5	
-110115	---				1.102	.433 - .453	-7/16E	-11 - 12
-115120	---		1.141			.453 - .472	-11.5 - 12.5	
-120125	---				1.180	.472 - .492	-12 - 13	
-125130	---		1.219			.492 - .512	-1/2E	-12.5 - 13
-130140	---	1.258		.512 - .551	-13 - 14.5			
-140150	---		1.297	.551 - .591	-9/16E	-14 - 15.5		
-150160	---	1.336		.591 - .630	-5/8E	-15 - 16.5		
-160170	---		1.375	.630 - .669	-16 - 17.5			
-170180	---	1.414		.669 - .709	-17 - 18.5			
-180190	---		1.453	.709 - .748	-18 - 19.5			
-190200	---	1.492		.748 - .787	-3/4E	-19 - 20		
-195210	---		1.531					
-200220	---	1.570						
-205230	---		1.609					
-210240	---	1.648						
-215250	---		1.687					
-220260	---	1.726						
-225270	---		1.765					
-230280	---	1.804						
-235290	---		1.843					
-240300	---	1.882						
-245310	---		1.921					
-250320	---	1.960						
-255330	---		2.000					
-260340	---	2.040						
-265350	---		2.080					
-270360	---	2.120						
-275370	---		2.160					
-280380	---	2.200						
-285390	---		2.240					
-290400	---	2.280						
-295410	---		2.320					
-300420	---	2.360						
-305430	---		2.400					
-310440	---	2.440						
-315450	---		2.480					
-320460	---	2.520						
-325470	---		2.560					
-330480	---	2.600						
-335490	---		2.640					
-340500	---	2.680						
-345510	---		2.720					
-350520	---	2.760						
-355530	---		2.800					
-360540	---	2.840						
-365550	---		2.880					
-370560	---	2.920						
-375570	---		2.960					
-380580	---	3.000						
-385590	---		3.040					
-390600	---	3.080						
-395610	---		3.120					
-400620	---	3.160						
-405630	---		3.200					
-410640	---	3.240						
-415650	---		3.280					
-420660	---	3.320						
-425670	---		3.360					
-430680	---	3.400						
-435690	---		3.440					
-440700	---	3.480						
-445710	---		3.520					
-450720	---	3.560						
-455730	---		3.600					
-460740	---	3.640						
-465750	---		3.680					
-470760	---	3.720						
-475770	---		3.760					
-480780	---	3.800						
-485790	---		3.840					
-490800	---	3.880						
-495810	---		3.920					
-500820	---	3.960						
-505830	---		4.000					
-510840	---	4.040						
-515850	---		4.080					
-520860	---	4.120						
-525870	---		4.160					
-530880	---	4.200						
-535890	---		4.240					
-540900	---	4.280						
-545910	---		4.320					
-550920	---	4.360						
-555930	---		4.400					
-560940	---	4.440						
-565950	---		4.480					
-570960	---	4.520						
-575970	---		4.560					
-580980	---	4.600						
-585990	---		4.640					
-5901000	---	4.680						
-5951100	---		4.720					
-6001200	---	4.760						
-6051300	---		4.800					
-6101400	---	4.840						
-6151500	---		4.880					
-6201600	---	4.920						
-6251700	---		4.960					
-6301800	---	5.000						
-6351900	---		5.040					
-6402000	---	5.080						
-6452100	---		5.120					
-6502200	---	5.160						
-6552300	---		5.200					
-6602400	---	5.240						
-6652500	---		5.280					
-6702600	---	5.320						
-6752700	---		5.360					
-6802800	---	5.400						
-6852900	---		5.440					
-6903000	---	5.480						
-6953100	---		5.520					
-7003200	---	5.560						
-7053300	---		5.600					
-7103400	---	5.640						
-7153500	---		5.680					
-7203600	---	5.720						
-7253700	---		5.760					
-7303800	---	5.800						
-7353900	---		5.840					
-7404000	---	5.880						
-7454100	---		5.920					
-7504200	---	5.960						
-7554300	---		6.000					
-7604400	---	6.040						
-7654500	---		6.080					
-7704600	---	6.120						
-7754700	---		6.160					
-7804800	---	6.200						
-7854900	---		6.240					
-7905000	---	6.280						
-7955100	---		6.320					
-8005200	---	6.360						
-8055300	---		6.400					
-8105400	---	6.440						
-8155500	---		6.480					
-8205600	---	6.520						
-8255700	---		6.560					
-8305800	---	6.600						
-8355900	---		6.640					
-8406000	---	6.680						
-8456100	---		6.720					
-8506200	---	6.760						
-8556300	---		6.800					
-8606400	---	6.840						
-8656500	---		6.880					
-8706600	---	6.920						
-8756700	---		6.960					
-8806800	---	7.000						
-8856900	---		7.040					
-8907000	---	7.080						
-8957100	---		7.120					
-9007200	---	7.160						
-9057300	---		7.200					
-9107400	---	7.240						
-9157500	---		7.280					
-9207600	---	7.320						
-9257700	---		7.360					
-9307800	---	7.400						
-9357900	---		7.440					
-9408000	---	7.480						
-9458100	---		7.520					
-9508200	---	7.560						
-9558300	---		7.600					
-9608400	---	7.640						
-9658500	---		7.680					
-9708600	---	7.720						
-9758700	---		7.760					
-9808800	---	7.800						
-9858900	---		7.840					
-9909000	---	7.880						
-9959100	---		7.920					
-10009200	---	7.960						
-10019300	---		8.000					
-10029400	---	8.040						
-10039500	---		8.080					
-10049600	---	8.120						
-10059700	---		8.160					
-10069800	---	8.200						
-10079900	---		8.240					
-10080000	---	8.280						
-10090100	---		8.320					
-10100200	---	8.360						
-10110300	---		8.400					
-10120400	---	8.440						
-10130500	---		8.480					
-10140600	---	8.520						
-10150700	---		8.560					
-10160800	---	8.600						
-10170900	---		8.640					
-10181000	---	8.680						
-10191100	---		8.720					
-10201200	---	8.760						
-10211300	---		8.800					
-10221400	---	8.840						
-10231500	---		8.880					
-10241600	---	8.920						
-10251700	---		8.960					
-10261800	---	9.000						
-10271900	---		9.040					
-10282000	---	9.080						
-10292100	---		9.120					
-10302200	---	9.160						
-10312300	---		9.200					
-10322400	---	9.240						
-10332500	---		9.280					
-10342600	---	9.320						
-10352700	---		9.360					
-10362800	---	9.400						
-10372900	---		9.440					
-10383000	---	9.480						
-10393100	---		9.520					
-10403200	---	9.560						
-10413300	---		9.600					
-10423400	---	9.640						
-10433500	---		9.680					
-10443600	---	9.720						
-10453700	---		9.760					
-10463800	---	9.800						
-10473900	---		9.840					
-10484000	---	9.880						
-10494100	---		9.920					
-10504200	---	9.960						
-10514300	---		10.000					
-10524400	---	10.040						
-10534500	---		10.080					
-10544600	---	10.120						
-10554700	---		10.160					
-10564800	---	10.200						
-10574900	---		10.240					
-10585000	---	10.280						
-1059510								

# CAT/BCV Shank

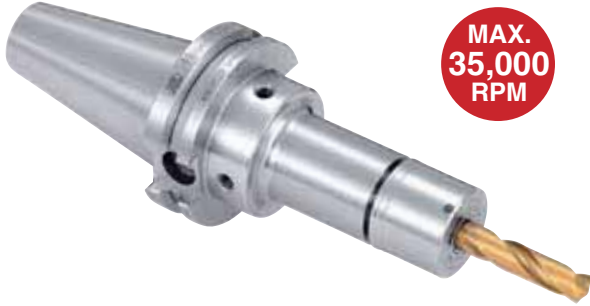

**MAX.  
35,000  
RPM**

Coolant through  
center or flange

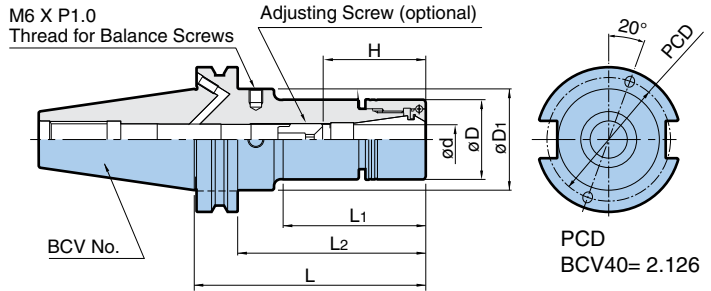

## CAT BCV40 Shank ASME B5.50-2009 (BIG-PLUS®)

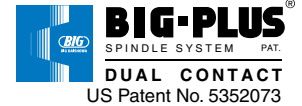

BIG-PLUS® tools can be used in machining centers with conventional spindles.

Model	ød	øD	øD1	L	L1	L2	H	Nut Model	Max RPM	Weight (lbs)
<b>BCV40-MEGAER16-3</b>	.075 - .394	1.181	1.75	3	1.50	2.24	1.38 - 1.85	MERN16	35,000	3.08
-4				4	2.48	3.27			25,000	3.30
-5				5	3.46	4.25			20,000	3.52
-6				6	4.49	5.24			15,000	3.96
<b>-MEGAER20-3</b>	.108 - .512	1.378	1.75	3	1.50	2.24	1.65 - 2.44	MERN20	30,000	3.30
-4				4	2.48	3.27			25,000	3.52
-5				5	3.50	4.25			20,000	3.96
-6				6	4.49	5.24			15,000	4.18
<b>-MEGAER25-3</b>	.108 - .630	1.654	1.75	3	1.61	2.28	1.73 - 2.56	MERN25	30,000	3.52
-4				4	2.60	3.27	1.73 - 2.64		20,000	3.96
-5				5	3.58	4.25			15,000	4.40
-6				6	4.61	5.24	12,000		4.84	
<b>-MEGAER32-3.25</b>	.108 - .787	1.969	1.75	3.25	-	2.52	1.97 - 2.68	MERN32	30,000	3.74
-4				4	3.27	20,000			4.40	
-5				5	4.25	15,000			5.06	
-6				6	5.24	12,000			5.94	

1. Mega ER Nut is included. Adjusting screw, collet and wrench must be ordered separately.
2. "H" indicates the adjustment length with an adjusting screw.
3. Balance screws are not included.
4. Mega ER Grip is not able to use DIN6499 Form-A collets and ESX collets.
5. Weight does not include collet.

Spare Parts		Accessories							
	Mega ER Nut 	Collet 	Wrench 	Sealing Nut Mega ER Perfect Seal 	Adjusting Screw 			Rubber 	Cleaner 
<b>Mega ER Grip</b>	Model	Model	Model	Model	Model	G	L	B (mm)	Model
MEGA ER16	<b>MERN16</b>	<b>ERC16-□</b>	<b>MGR30L</b>	<b>MERPS16-□</b>	<b>NBA10B</b>	M11	.63	3	<b>SC-MER16</b>
MEGA ER20	<b>MERN20</b>	<b>ERC20-□</b>	<b>MGR35L</b>	<b>MERPS20-□</b>	<b>NBA13B</b>	M14	.79	4	<b>SC-MER20</b>
MEGA ER25	<b>MERN25</b>	<b>ERC25-□</b>	<b>MGR42L</b>	<b>MERPS25-□</b>	<b>NBA16B</b>	M18	.79	4	<b>SC-MER25</b>
MEGA ER32	<b>MERN32</b>	<b>ERC32-□</b>	<b>MGR50L</b>	<b>MERPS32-□</b>	<b>NBA20B</b>	M21	.79	4	<b>SC-MER32</b>

1. Please be aware that the rubber seal in the adjusting screw may be stripped off due to high pressure coolant.



**Caution**

To maintain the accuracy of the tool assembly, do not use collets and nuts manufactured by another company with the chuck body of BIG's Mega ER Grip. Also, we cannot guarantee the accuracy statement for our collets if they are assembled on the chuck body of another manufacturer.



Coolant through center or flange

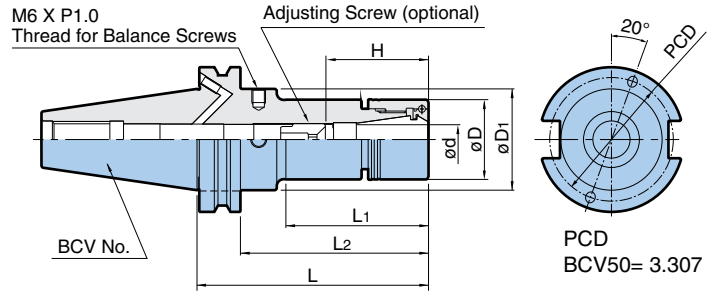

**CAT BCV50 Shank ASME B5.50-2009 (BIG-PLUS®)**

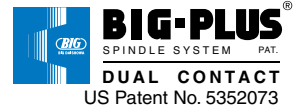

BIG-PLUS® tools can be used in machining centers with conventional spindles.

Model	ød	øD	øD1	L	L1	L2	H	Nut Model	Max RPM	Weight (lbs)
<b>BCV50-MEGAER16-3.5</b>	.075 - .394	1.181	2.75	3.5	1.85	2.76	1.39 - 1.84	MERN16	20,000	8.36
-5				5	3.35	4.25				
-6				6	4.33	5.24				
<b>-MEGAER20-3.5</b>	.108 - .512	1.378	2.75	3.5	1.85	2.76	1.65 - 2.43	MERN20	18,000	8.58
-5				5	3.35	4.25				
-6				6	4.33	5.24				
<b>-MEGAER25-3.5</b>	.108 - .630	1.654	2.75	3.5	1.85	2.76	1.74 - 2.65	MERN25	17,000	8.80
-5				5	3.35	4.25				
-6				6	4.33	5.24				
<b>-MEGAER32-3.5</b>	.108 - .787	1.969	2.75	3.5	1.89	2.76	1.97 - 2.68	MERN32	16,000	9.02
-5				5	3.39	4.25				
-6				6	4.37	5.24				

1. Mega ER Nut is included. Adjusting screw, collet and wrench must be ordered separately.
2. "H" indicates the adjustment length with an adjusting screw.
3. Balance screws are not included.
4. Mega ER Grip is not able to use DIN6499 Form-A collets and ESX collets.
5. Weight does not include collet.

Spare Parts		Accessories							
Mega ER Nut	Model	Collet	Wrench	Sealing Nut Mega ER Perfect Seal	Adjusting Screw			Cleaner	
Mega ER Grip	Model	Model	Model	Model	Model	G	L	B (mm)	Model
MEGA ER16	MERN16	ERC16-□	MGR30L	MERPS16-□	NBA10B	M11	.63	3	SC-MER16
MEGA ER20	MERN20	ERC20-□	MGR35L	MERPS20-□	NBA13B	M14	.79	4	SC-MER20
MEGA ER25	MERN25	ERC25-□	MGR42L	MERPS25-□	NBA16B	M18	.79	4	SC-MER25
MEGA ER32	MERN32	ERC32-□	MGR50L	MERPS32-□	NBA20B	M21	.79	4	SC-MER32

1. Please be aware that the rubber seal in the adjusting screw may be stripped off due to high pressure coolant.

● Plug Screw for flange through coolant

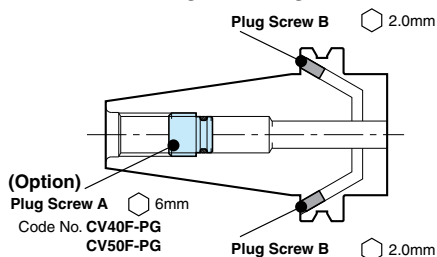

This Plug Screw A (option) prevents coolant leakage through the retention knob.

Bores on Form B are sealed with Plug Screw B.

- \*Remove 2 pcs. Plug Screw B from end face of flange.
- \*Failure to use the Plug Screw A or other sealing method may result in coolant contamination of the spindle and lead to premature failure or accidents.

# HSK Shank



**MAX.  
33,000  
RPM**

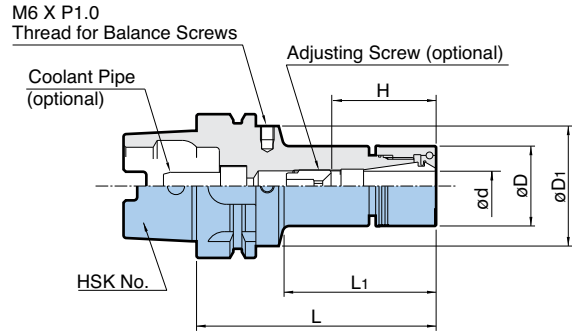

## HSK63 Form A Shank ISO12164 & DIN69893

Model	Clamping Range ød	øD	øD1	L	L1	H	Nut Model	Max RPM	Weight (lbs)
<b>HSK-A63-MEGAER16-70</b> ※	.075 - .394	1.181	2.071	2.756	1.260	1.77	MERN16	33,000	2.20
<b>-90</b>				3.543	1.929	1.38 - 1.85		33,000	2.42
<b>-105</b>				4.134	2.520			25,000	2.42
<b>-135</b>				5.315	3.701			20,000	2.86
<b>-165</b>				6.496	4.882			15,000	3.08
<b>-MEGAER20-70</b> ※	.108 - .512	1.378	2.071	2.756	1.260	1.77	MERN20	30,000	2.20
<b>-90</b> ※				3.543	1.929	1.65		30,000	2.42
<b>-105</b>				4.134	2.520	1.65 - 2.13		25,000	2.64
<b>-135</b>				5.315	3.701	1.65 - 2.44		20,000	3.08
<b>-165</b>				6.496	4.882			15,000	3.52
<b>-MEGAER25-70</b> ※	.108 - .630	1.654	2.071	2.756	1.260	1.77	MERN25	30,000	2.42
<b>-90</b> ※				3.543	1.969	2.44		25,000	2.64
<b>-105</b>				4.134	2.559	1.7.3 - 2.17		20,000	3.08
<b>-135</b>				5.315	3.740	1.73 - 2.65		15,000	3.74
<b>-165</b>				6.496	4.921			10,000	4.18
<b>-MEGAER32-75</b> ※	.108 - .787	1.969	2.071	2.953	1.299	1.97	MERN32	30,000	2.86
<b>-90</b> ※				3.543	1.850	2.40		25,000	3.30
<b>-105</b>				4.134	2.441	1.97 - 2.13		20,000	3.74
<b>-135</b>				5.315	3.622	1.97 - 2.68		15,000	4.40
<b>-165</b>				6.496	4.803			10,000	5.28

1. Mega ER Nut is included. Adjusting screw, collet and wrench must be ordered separately.
2. "H" indicates the adjustment length with an adjusting screw.
3. Adjusting screws cannot be used with models marked ※.

4. Balance screws are not included.
5. Coolant pipe must be ordered separately.
6. Mega ER Grip is not able to use DIN6499 Form-A collets and ESX collets.
7. Weight does not include collet.

Spare Parts		Accessories							
Mega ER Nut		Collet	Wrench	Sealing Nut Mega ER Perfect Seal	Adjusting Screw	Rubber	Cleaner		
<b>Mega ER Grip</b>	Model	Model	Model	Model	Model	G	L	B (mm)	Model
MEGA ER16	<b>MERN16</b>	<b>ERC16-□</b>	<b>MGR30L</b>	<b>MERPS16-□</b>	<b>NBA10B</b>	M11	.63	3	<b>SC-MER16</b>
MEGA ER20	<b>MERN20</b>	<b>ERC20-□</b>	<b>MGR35L</b>	<b>MERPS20-□</b>	<b>NBA13B</b>	M14	.79	4	<b>SC-MER20</b>
MEGA ER25	<b>MERN25</b>	<b>ERC25-□</b>	<b>MGR42L</b>	<b>MERPS25-□</b>	<b>NBA16B</b>	M18	.79	4	<b>SC-MER25</b>
MEGA ER32	<b>MERN32</b>	<b>ERC32-□</b>	<b>MGR50L</b>	<b>MERPS32-□</b>	<b>NBA20B</b>	M21	.79	4	<b>SC-MER32</b>

1. Please be aware that the rubber seal in the adjusting screw may be stripped off due to high pressure coolant.



**Caution**

To maintain the accuracy of the tool assembly, do not use collets and nuts manufactured by another company with the chuck body of BIG's Mega ER Grip. Also, we cannot guarantee the accuracy statement for our collets if they are assembled on the chuck body of another manufacturer.

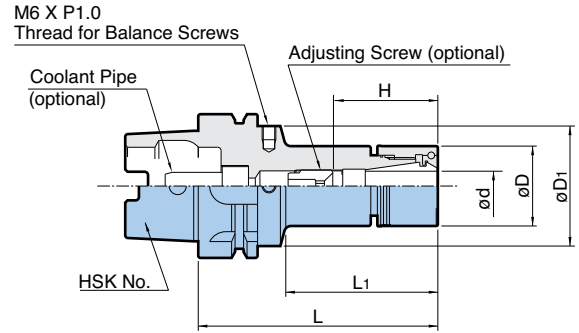

**HSK100 Form A Shank ISO12164 & DIN69893**

Model	Clamping Range ød	øD	øD1	L	L1	H	Nut Model	Max RPM	Weight (lbs)
<b>HSK-A100-MEGAER16-75</b> ※	.075 - .394	1.181	3.346	2.953	1.220	1.83	MERN16	20,000	7.26
-105				4.134	2.323	1.38 - 1.85		18,000	7.48
-135				5.315	3.504			14,000	7.92
-165				6.496	4.685	14,000		8.14	
<b>-MEGAER20-75</b> ※	.108 - .512	1.378	3.346	2.953	1.220	1.77	MERN20	18,000	7.48
-105				4.134	2.323	1.65 - 2.13		16,000	7.70
-135				5.315	3.504			14,000	8.14
-165				6.496	4.685	1.65 - 2.44		14,000	8.58
<b>-MEGAER25-75</b> ※	.108 - .630	1.654	3.346	2.953	1.260	1.73	MERN25	15,000	7.48
-105				4.134	2.323	1.73 - 1.97		14,000	8.14
-135				5.315	3.504			1.73 - 2.65	13,000
-165				6.496	4.685	13,000			9.24
<b>-MEGAER32-80</b> ※	.108 - .787	1.969	3.346	3.150	1.417	1.93	MERN32	15,000	7.92
-105				4.134	2.323	1.97		14,000	8.58
-135				5.315	3.504			1.97 - 2.68	13,000
-165				6.496	4.685	13,000			10.34

1. Mega ER Nut is included. Adjusting screw, collet and wrench must be ordered separately.
2. "H" indicates the adjustment length with an adjusting screw.
3. Adjusting screws cannot be used with models marked ※.
4. Balance screws are not included.
5. Coolant pipe must be ordered separately.
6. Mega ER Grip is not able to use DIN6499 Form-A collets and ESX collets.
7. Weight does not include collet.

Spare Parts		Accessories							
Mega ER Nut	Collet	Wrench	Sealing Nut Mega ER Perfect Seal	Adjusting Screw			Cleaner		
Mega ER Grip	Model	Model	Model	Model	G	L	B (mm)	Model	
MEGA ER16	<b>MERN16</b>	<b>ERC16-□</b>	<b>MGR30L</b>	<b>MERPS16-□</b>	<b>NBA10B</b>	M11	.63	3	<b>SC-MER16</b>
MEGA ER20	<b>MERN20</b>	<b>ERC20-□</b>	<b>MGR35L</b>	<b>MERPS20-□</b>	<b>NBA13B</b>	M14	.79	4	<b>SC-MER20</b>
MEGA ER25	<b>MERN25</b>	<b>ERC25-□</b>	<b>MGR42L</b>	<b>MERPS25-□</b>	<b>NBA16B</b>	M18	.79	4	<b>SC-MER25</b>
MEGA ER32	<b>MERN32</b>	<b>ERC32-□</b>	<b>MGR50L</b>	<b>MERPS32-□</b>	<b>NBA20B</b>	M21	.79	4	<b>SC-MER32</b>

1. Please be aware that the rubber seal in the adjusting screw may be stripped off due to high pressure coolant.

**COOLANT PIPE for Form A**

- Mono Block Type

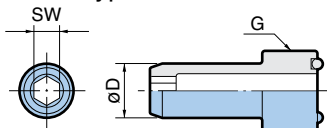

- 1° Swing Type

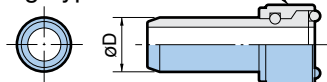

**Caution**  
For machines capable of supplying coolant through spindle, the coolant pipe should be fitted to all HSK holders to protect against accidental selection of coolant.

Model	øD	G	SW (mm)
<b>HSK63-CP</b>	.472	M18 x P1	6
<b>100-CP</b>	.630	M24 x P1.5	8

Model	øD	G	Wrench (optional)
<b>HSK63-CPM</b>	.472	M18 x P1	CPW63
<b>100-CPM</b>	.630	M24 x P1.5	CPW100

# BIG COROMANT CAPTO® Shank

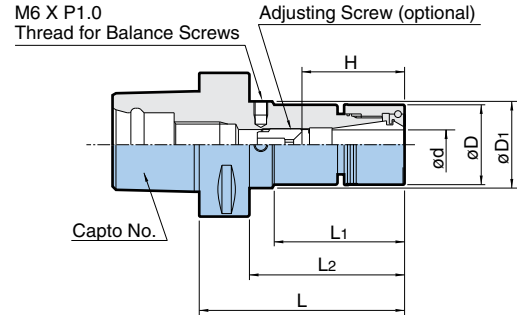

## C4 & C5 Shank BIG Coromant Capto®

Model	Clamping Range ød	øD	øD1	L	L1	L2	H	Nut Model	Weight (lbs)
<b>C4-MEGAER16-50</b> ※	.075 - .394	1.181	–	1.969	–	1.181	1.73	MERN16	.88
<b>-75</b> ※			1.378	2.953	1.634	1.969	1.38 - 1.85		1.32
<b>-MEGAER20-50</b> ※	.108 - .512	1.378	–	1.969	–	1.181	1.73	MERN20	1.10
<b>-75</b> ※			1.496	2.953	1.654	2.165	2.72		1.54
<b>-MEGAER25-50</b> ※	.108 - .630	1.654	–	1.969	–	1.220	1.77	MERN25	1.32
<b>-75</b> ※			2.953	–	2.244	2.72	1.76		
<b>C5-MEGAER16-60</b> ※	.075 - .394	1.181	1.378	2.362	1.102	1.575	2.09	MERN16	1.54
<b>-90</b>				3.543	2.224	2.756	1.38 - 1.85		1.98
<b>-105</b>				4.134	2.815	3.346			2.20
<b>-135</b>				5.315	3.996	4.528			2.64
<b>-MEGAER20-60</b> ※	.108 - .512	1.378	1.496	2.362	1.161	1.575	2.09	MERN20	1.76
<b>-90</b>				3.543	2.283	2.756	1.65 - 2.44		1.98
<b>-105</b>				4.134	2.835	3.346			2.20
<b>-135</b>				5.315	4.016	4.528			2.86
<b>-MEGAER25-65</b> ※	.108 - .630	1.654	–	2.559	–	1.772	2.28	MERN25	1.98
<b>-90</b>			3.543	–	2.677	1.73 - 2.28	2.42		
<b>-105</b>			4.134	–	3.346	1.73 - 2.64	2.64		
<b>-135</b>			5.315	–	4.528	3.30			
<b>-MEGAER32-70</b> ※	.108 - .787	1.969	–	2.756	–	1.969	2.48	MERN32	2.20
<b>-90</b>			3.543	–	2.756	1.97 - 2.32	2.64		
<b>-105</b>			4.134	–	3.346	1.97 - 2.68	3.08		
<b>-135</b>			5.315	–	4.528	3.96			

1. Mega ER Nut is included. Adjusting screw, collet and wrench must be ordered separately.
2. "H" indicates the adjustment length with an adjusting screw.
3. Adjusting screws cannot be used with models marked ※.

4. Balance screws are not included.
5. Mega ER Grip is not able to use DIN6499 Form-A collets and ESX collets.
6. Weight does not include collet.



BIG Coromant Capto is a licensed product from Sandvik Coromant Sweden. Products described herein are fully compatible.

Spare Parts		Accessories							
	Mega ER Nut 	Collet 	Wrench 	Sealing Nut Mega ER Perfect Seal 	Adjusting Screw 			Cleaner 	
<b>Mega ER Grip</b>	Model	Model	Model	Model	Model	G	L	B (mm)	Model
MEGA ER16	<b>MERN16</b>	<b>ERC16-□</b>	<b>MGR30L</b>	<b>MERPS16-□</b>	<b>NBA10B</b>	M11	.63	3	<b>SC-MER16</b>
MEGA ER20	<b>MERN20</b>	<b>ERC20-□</b>	<b>MGR35L</b>	<b>MERPS20-□</b>	<b>NBA13B</b>	M14	.79	4	<b>SC-MER20</b>
MEGA ER25	<b>MERN25</b>	<b>ERC25-□</b>	<b>MGR42L</b>	<b>MERPS25-□</b>	<b>NBA16B</b>	M18	.79	4	<b>SC-MER25</b>
MEGA ER32	<b>MERN32</b>	<b>ERC32-□</b>	<b>MGR50L</b>	<b>MERPS32-□</b>	<b>NBA20B</b>	M21	.79	4	<b>SC-MER32</b>

1. Please be aware that the rubber seal in the adjusting screw may be stripped off due to high pressure coolant.



**Caution**

To maintain the accuracy of the tool assembly, do not use collets and nuts manufactured by another company with the chuck body of BIG's Mega ER Grip. Also, we cannot guarantee the accuracy statement for our collets if they are assembled on the chuck body of another manufacturer.

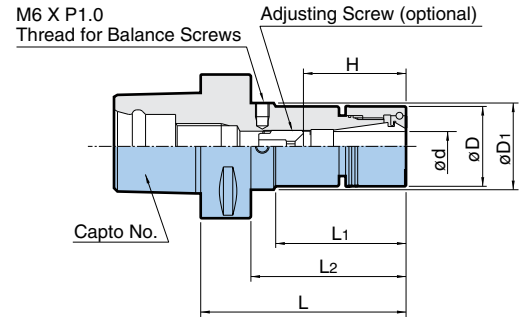

**C6 & C8 Shank BIG Coromant Capto®**

Model	Clamping Range ød	øD	øD1	L	L1	L2	H	Nut Model	Weight (lbs)
<b>C6-MEGAER16-60</b> ※	.075 - .394	1.181	1.378	2.362	1.102	1.496	2.01	MERN16	2.86
-90				3.543	2.146	2.677	3.08		
-105				4.134	2.736	3.268	1.38 - 1.85		3.30
-135				5.315	3.917	4.449	3.52		
<b>-MEGAER20-65</b> ※	.108 - .512	1.378	1.496	2.559	1.161	1.693	2.20	MERN20	2.86
-90				3.543	2.165	2.677	1.65 - 2.28		3.30
-105				4.134	2.756	3.268	1.65 - 2.44		3.52
-135				5.315	3.937	4.449	3.74		
-165	6.496	5.118	5.630	4.18					
<b>-MEGAER25-65</b> ※	.108 - .630	1.654	-	2.559	-	1.693	2.20	MERN25	3.08
-90				3.543	-	2.677	1.73 - 2.32		3.52
-105				4.134	-	3.268	1.73 - 2.64		3.74
-135				5.315	-	4.449	4.40		
-165	6.496	-	5.630	4.84					
<b>-MEGAER32-70</b> ※	.108 - .787	1.969	-	2.756	-	1.890	2.52	MERN32	3.30
-90				3.543	-	2.677	1.97 - 2.32		3.96
-105				4.134	-	3.268	1.97 - 2.68		4.18
-135				5.315	-	4.449	5.06		
-165	6.496	-	5.630	5.72					
<b>C8-MEGAER16-75</b>	.075 - .394	1.181	1.378	2.953	1.276	1.772	1.38 - 1.85	MERN16	5.72
-105				4.134	2.421	2.953			6.16
-135				5.315	3.602	4.134			6.38
-165				6.496	4.783	5.315			6.60
<b>-MEGAER20-75</b>	.108 - .512	1.378	1.496	2.953	1.319	1.772	1.65 - 2.05	MERN20	5.94
-105				4.134	2.441	2.953	1.65 - 2.44		6.82
-135				5.315	3.622	4.134	7.48		
-165				6.496	4.803	5.315	7.92		
<b>-MEGAER25-75</b> ※	.108 - .630	1.654	-	2.953	-	1.772	2.95	MERN25	6.16
-105				4.134	-	2.953	6.82		
-135				5.315	-	4.134	7.26		
-165				6.496	-	5.315	7.92		
<b>-MEGAER32-75</b> ※	.108 - .787	1.969	-	2.953	-	1.772	2.95	MERN32	6.60
-105				4.134	-	2.953	7.26		
-135				5.315	-	4.134	8.14		
-165				6.496	-	5.315	9.02		

- Mega ER Nut is included. Adjusting screw, collet and wrench must be ordered separately.
- "H" indicates the adjustment length with an adjusting screw.
- Adjusting screws cannot be used with models marked ※.

- Balance screws are not included.
- Mega ER Grip is not able to use DIN6499 Form-A collets and ESX collets.
- Weight does not include collet.



BIG Coromant Capto is a licensed product from Sandvik Coromant Sweden. Products described herein are fully compatible.

Spare Parts		Accessories							
Mega ER Grip	Model	Collet	Wrench	Sealing Nut Mega ER Perfect Seal	Adjusting Screw			Cleaner	
		Model	Model	Model	Model	G	L	B (mm)	Model
MEGA ER16	MERN16	ERC16-□	MGR30L	MERPS16-□	NBA10B	M11	.63	3	SC-MER16
MEGA ER20	MERN20	ERC20-□	MGR35L	MERPS20-□	NBA13B	M14	.79	4	SC-MER20
MEGA ER25	MERN25	ERC25-□	MGR42L	MERPS25-□	NBA16B	M18	.79	4	SC-MER25
MEGA ER32	MERN32	ERC32-□	MGR50L	MERPS32-□	NBA20B	M21	.79	4	SC-MER32

1. Please be aware that the rubber seal in the adjusting screw may be stripped off due to high pressure coolant.

**MEGA ER GRIP**

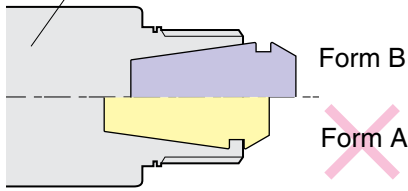

### Regarding the compatibility between DIN collets and Mega ER Grip

The internal taper of the Mega ER Grip tool body has a larger gauge line diameter compared to conventional holders made to the DIN standard. The reason is to increase the length of contact between the collet and holder for improved clamping force.

**As a consequence, only DIN6499 Form B collets can be used with a restricted clamping range of 0.5mm/Ø (0.020"/Ø). Form A collets cannot be used.**

## Accessories

### MEGA ER NUT

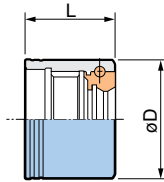

A notch-free nut prevents vibration and noise. Steel balls in the thrust bearing are retained by a mechanism inside the nut designed for high speed operation.

Model	øD	L	Body
MERN16	1.181	.984	MEGA ER16
MERN20	1.378	1.043	MEGA ER20
MERN25	1.654	1.083	MEGA ER25
MERN32	1.969	1.189	MEGA ER32

### ADJUSTING SCREW

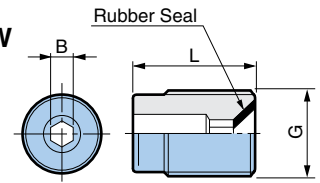

For adjusting the projection length of a cutting tool.

Model	G	L	B (mm)	Body
NBA10B	M11	.63	3	MEGA ER16
NBA13B	M14	.79	4	MEGA ER20
NBA16B	M18	.79	4	MEGA ER25
NBA20B	M21	.79	4	MEGA ER32

1. Please be aware that the rubber seal in the adjusting screw may be stripped off due to high pressure coolant.

### MEGA WRENCH PAT. US Patent No. 5596913

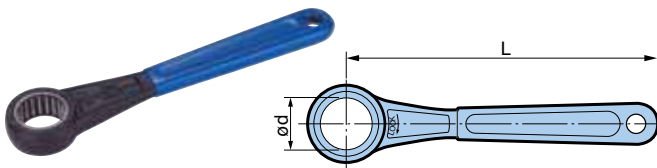

Model	L	ød	Body
MGR30L	8.66	1.181	MEGA ER16
MGR35L	9.45	1.378	MEGA ER20
MGR42L	10.24	1.654	MEGA ER25
MGR50L	11.18	1.969	MEGA ER32

### α TAPER CLEANER

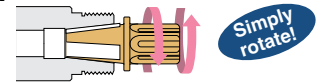

Maintain the accuracy of ER collet chucks! Easy cleaning of internal collet taper by simply inserting and rotating!

Model	Body
SC-MER16	MEGA ER16
-MER20	MEGA ER20
-MER25	MEGA ER25
-MER32	MEGA ER32

**BIG KAISER**<sup>®</sup>  
**PRECISION TOOLING INC.**

2600 Huntington Blvd., Hoffman Estates, IL 60192  
Tel: 847.228.7660 • Fax: 847.228.0881

web: www.bigkaiser.com • e-mail: bigkaiser@bigkaiser.com

CATALOG No.EXi166-0410-1