

BIG KAISER



HIGH PERFORMANCE TOOLING SOLUTIONS 2018-2019

BIG KAISER

A Member of the BIG DAISHOWA Group

PREMIUM PROVIDER OF TOOLING SOLUTIONS

Tooling for advanced metalworking environments, from standard production machining challenges to extreme precision and complex applications, these superior products deliver lower costs through higher efficiency.

With our superior technologies and state-of-the-art production facilities, we guarantee to offer "High Precision" and "High Quality" tools to your satisfaction.



This Catalog Contains Patents and Trademarks of the BIG DAISHOWA Group Pending and Patented at the U.S. Patent Office

BCV/CV SHANKS	A.1 56-105
BBT/BT SHANKS	A.2 106-167
HSK SHANKS	A.3 168-229
BIG CAPTO SHANKS	A.4 230-259
CK/CKB SHANKS	A.5 260-273
CYLINDRICAL SHANKS N/C LATHE TOOLING	A.6 274-297
MILLTURN TOOLING	A.7 298-331
TOOL HOLDER ACCESSORIES	A.8 332-391
ROUGH BORING HEADS	B.1 392-411
CENTRIC CUTTING EDGE FINE BORING HEADS	B.2 412-451
PERIPHERICAL CUTTING EDGE FINE BORING HEADS	B.3 452-475
LARGE DIAMETER BORING HEADS	B.4 476-505
INDEXABLE INSERTS	B.5 506-527
CUTTING TOOLS	C.1 528-593
ACCESSORIES	D.1 594-623

COLLET CHUCKS



CLAMPING RANGE:
 ø.018"-.317"
 (ø.45-8.05mm)

MAX
50,000
 RPM

OVERVIEW ▶ 18

MEGA MICRO CHUCK

BCV SHANK 58
 BBT SHANK 108
 HSK SHANK 170/212/221
 BIG CAPTO SHANK 234
 ST SHANK 276
 N/C LATHE 287

COLLET CHUCKS



CLAMPING RANGE:
 ø.010"-1.000"
 (ø.25-25.4mm)

MAX
40,000
 RPM

OVERVIEW ▶ 19

MEGA NEW BABY CHUCK

BCV SHANK 59
 BBT SHANK 110
 HSK SHANK 172/214
 BIG CAPTO TYPE 236

COLLET CHUCKS



CLAMPING RANGE:
 ø.010"-.787"
 (ø.25-20mm)

MAX
25,000
 RPM

OVERVIEW ▶ 24

NEW BABY CHUCK

ST SHANK 278
 N/C LATHE 290

COLLET CHUCKS



CLAMPING RANGE:
 ø.075"-.787"
 (ø1.9-20mm)

MAX
35,000
 RPM

OVERVIEW ▶ 20

MEGA ER GRIP

BCV SHANK 61
 BBT SHANK 114
 HSK SHANK 176
 BIG CAPTO TYPE 240
 CKB SHANK 265
 ST SHANK 288

COLLET CHUCKS



CLAMPING RANGE:
 ø.125"-.500"
 (ø3-12mm)

MAX
40,000
 RPM

OVERVIEW ▶ 21

MEGA E CHUCK

BCV SHANK 62
 BBT SHANK 116
 HSK SHANK 178/223
 BIG CAPTO SHANK 242

MILLING CHUCKS



CLAMPING RANGE:
 ø.625"-1.500"
 (ø16-50mm)

MAX
30,000
 RPM

OVERVIEW ▶ 22

MEGA DOUBLE POWER CHUCK

BCV SHANK 63
 BBT SHANK 48
 HSK SHANK 180/224
 BIG CAPTO SHANK 244

MILLING CHUCKS



CLAMPING RANGE:
 ø.750"-1.250"
 (ø16-32mm)

OVERVIEW ▶ 23

MEGA PERFECT GRIP

BCV SHANK 65
 BBT SHANK 120
 HSK SHANK 181

MILLING CHUCKS



CLAMPING RANGE:
 ø.500"-1.500"
 (ø16-42mm)

OVERVIEW ▶ 25

NEW Hi-POWER MILLING CHUCK

BCV SHANK 66
 BBT/BT SHANK 122
 HSK SHANK 182
 BIG CAPTO SHANK 247
 CKB SHANK 266
 ST SHANK 280

HYDRAULIC CHUCKS



CLAMPING RANGE:
 ø.125"-1.250"
 (ø3-32mm)

OVERVIEW ▶ 26

HYDRAULIC CHUCK

BCV SHANK 68
 BBT SHANK 124
 HSK SHANK 184/216/225
 BIG CAPTO SHANK 248
 ST SHANK 281

BASIC ARBORS



CLAMPING RANGE:
ø.250"-1.250"
(ø4-20mm)

SHRINK FIT HOLDERS

BCV SHANK	71
BBT SHANK	132
HSK SHANK	188/218
BIG CAPTO SHANK	250
ST SHANK	282

BASIC ARBORS



SHELL/FACE/END MILL

BCV SHANK	72
BBT/BT SHANK	134
HSK SHANK	191/226
BIG CAPTO SHANK	251
CKB SHANK	262

BASIC ARBORS



OVERVIEW ▶37

SMART DAMPER FACE MILL ARBOR TYPE FMH

BCV SHANK	77
BBT SHANK	139
HSK SHANK	194

TURNING BORING BAR

ST SHANK	294
----------------	-----

TAP HOLDERS



OVERVIEW ▶28

MEGA SYNCHRO TAPPING HOLDER

BCV SHANK	78
BBT/BT SHANK	141
HSK SHANK	196
BIG CAPTO SHANK	256
CKB SHANK	267
ST SHANK	285
N/C LATHE	285

MODULAR HOLDERS



OVERVIEW ▶30

CK SHANKS/BIG CAPTO/ABS

BCV/CV SHANK	80-85
BBT/BT SHANK	142
HSK SHANK	198/219/227
BIG CAPTO SHANK	257
ST SHANK	286

ANGLE HEADS



OVERVIEW ▶40

ANGLE HEAD

BCV SHANK	86
BBT SHANK	148
HSK SHANK	200

SPEED INCREASERS



OVERVIEW ▶43

AIR POWER SPINDLE

BCV SHANK	96
BBT SHANK	158/220
HSK SHANK	210

SPEED INCREASERS



OVERVIEW ▶42

HIGH SPINDLE

BCV SHANK	98
BBT SHANK	160

COOLANT INDUCERS



OVERVIEW ▶44

Hi-JET HOLDER

CV SHANK	100
BBT/BT SHANK	162

MILLTURN TOOLING



OVERVIEW ▶38

BCV/CV SHANK	302
BBT/BT SHANK	306
HSK SHANK	312
BIG CAPTO SHANK	318
ST SHANK	294

TOOL HOLDER ACCESSORIES



PULLSTUD BOLT

CV SHANK	102
BT SHANK	164

CAUTION ⚠

Only use Pullstud Bolts made by BIG. Accuracy is not guaranteed if poor-quality Pullstud Bolts are used.

TOOL HOLDER ACCESSORIES



OVERVIEW ▶45

HIGH-PRECISION TEST BAR DYNA TEST

CV SHANK	103
BT SHANK	166
HSK SHANK	229
BIG CAPTO SHANK	259

TOOL HOLDER ACCESSORIES



**ATC ARM POSITIONING TOOL
ATC ALIGNMENT TOOL**

CV SHANK	103
BT SHANK	167

TOOL HOLDER ACCESSORIES



BIG-PLUS CLEANER

CV SHANK	103
BT SHANK	167

TOOL HOLDER ACCESSORIES



CLEANERS

TK CLEANER	372
α WIPER CLEANER	371
α TAPER CLEANER	337/351/358

ROUGH BORING



OVERVIEW ▶31

MW
ø.63"-83" (ø16-21mm) 395

SW
ø.79"-8.00" (ø20-203mm) 397

TWN
ø.79"-8.00" (ø20-203mm) 406

FINISH BORING



OVERVIEW ▶32

EWE
ø.08"-6.00" (ø2-152mm) 416
ø1.61"-8.00" (ø41-203mm) 455

EWN
ø.016"-6.00" (ø0.4-152mm) 417
ø.79"-8.00" (ø20-203mm) 456

EWB
ø.08"-1.97" (ø2-50mm) 417
ø1.26"-4.13" (ø32-105mm) 466
ø3.94"-8.00" (ø100-203mm)..... 467

ROUGH & FINISH BORING



OVERVIEW ▶36

**SMART DAMPER
CK BORING SYSTEM**

SW SMART DAMPER	399
EWD/EWN SMART DAMPER	459

LARGE DIAMETER BORING



OVERVIEW ▶ 34

SERIES 318

ø7.87"-24.41" (ø200-620mm) 479
 ø24.41"-118.00" (620-3000mm) 488

INDEXABLE INSERTS



INDEXABLE INSERTS 508

DRILLS



INDEXABLE INSERT & SPADE DRILLS

CKB SHANK 530

INDEXABLE END MILLS



OVERVIEW ▶ 48

FULLCUT MILL

BCV SHANK 542/550
 BBT SHANK 543/551
 HSK TYPE 545/553
 BIG CAPTO SHANK 555
 ST TYPE 547/556

EXCHANGEABLE HEAD MILLING TOOLS



CONTACT GRIP

BBT SHANK 564
 HSK SHANK 565
 BIG CAPTO SHANK 565

FACE MILLS



OVERVIEW ▶ 51

FULLCUT MILL

ARBOR TYPE 567

FACE MILLS



OVERVIEW ▶ 50

SPEED FINISHER 568
SURFACE MILL 570

CHAMFER MILLS



OVERVIEW ▶ 52

C-CUTTER MINI

ST TYPE 572
 CKB TYPE 576

CHAMFER MILLS



OVERVIEW ▶ 53

C-CUTTER

ST TYPE 578
 CKB TYPE 579

CHAMFER MILLS



C-CUTTER MICRO
ST TYPE 582

C-CENTERING CUTTER
ST TYPE 583

CHAMFER MILLS



OVERVIEW ▶ 54

CENTER BOY
ST TYPE 584

C-CUTTER BOY
ST TYPE 585

RADIUS MILLS



OVERVIEW ▶ 54

R-CUTTER
ST TYPE 586
CKB TYPE 588

BACK SPOT FACING TOOL



OVERVIEW ▶ 55

BF-CUTTER
ST TYPE 590

GROOVE MILLING TOOLS



GROOVE MILLING CUTTERS WITH CARBIDE INSERTS
ST TYPE 592
CK TYPE 592
ARBOR TYPE 592

MEASURING INSTRUMENTS



OVERVIEW ▶ 46

TOUCH PROBE & EDGE FINDER
POINT MASTER SERIES 596

MEASURING INSTRUMENTS



OVERVIEW ▶ 47

TOOL OFFSET SENSOR
BASE MASTER 602
BASE MASTER GOLD 602
BASE MASTER RED 603
BASE MASTER MICRO 603
BASE MASTER MINI 604

MEASURING INSTRUMENTS



OVERVIEW ▶ 47

TOOL OFFSET SENSOR
TOOL MASTER 604

MEASURING INSTRUMENTS



OVERVIEW ▶ 46

TOUCH PROBE & EDGE FINDER
3D MASTER RED 605
ACCU CENTER 605

MEASURING INSTRUMENTS



OVERVIEW ▶45

MEASURING DEVICE FOR PULLING FORCE

DYNA FORCE 607
 DYNA LINE 608
 DYNA CONTACT 610

MEASURING INSTRUMENTS



PRECISION MACHINE LEVEL

LEVEL MASTER 611

MEASURING INSTRUMENTS



DIAL INDICATOR STANDS

MP-TEC 612

TOOL ASSEMBLY DEVICES



TOOL HOLDING DEVICES

TOOLPRO 615
 TOOLING MATE 617
 TORQUE FIT 619

TOOL ASSEMBLY DEVICES



TOOL HOLDING DEVICES

KOMBI GRIP 616
 ST LOCK 616

CLEANERS



TAPER & FLANGE CLEANERS

SPINDLE CLEANER 621
 HSK EXTERNAL TAPER CLEANER 621
 α TOOLING CLEANER 620

CLEANERS

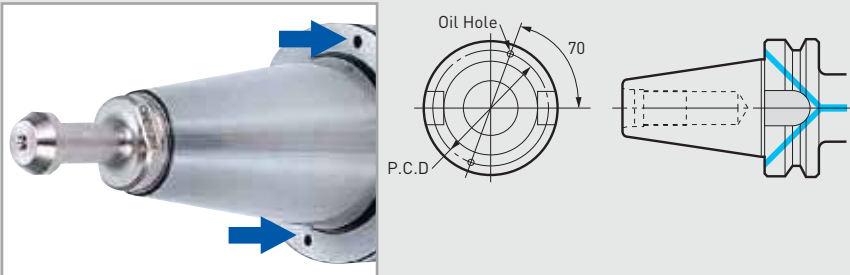

TABLE CLEANING

CHIPFAN 622
 T-SLOT CLEAN 623

FLANGE THROUGH COOLANT

We offer DIN69871/B flange through coolant upon request.



CAUTION ⚠

Tool holders modified for flange through coolant must use proper pullstud to seal back flow of coolant into the spindle.

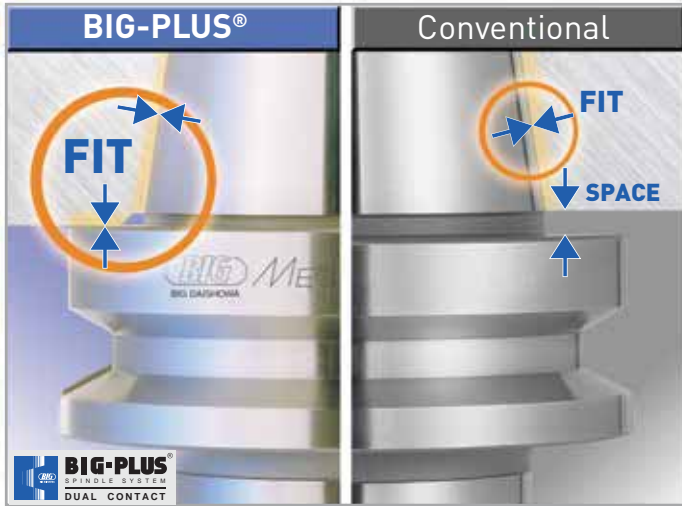

BIG-PLUS[®]

Simultaneous Taper & Flange Fit

BIG-PLUS surpasses all other spindle concepts while offering interchangeability with existing machines and tool holders.

- Improved surface finish & dimensional accuracy
- Extended tool life
- Prevention of fretting corrosion caused by heavy cutting
- Improvement of ATC repeatability
- Elimination of Z-axial movement at high speeds
- Improved roundness of boring operations

Basic Concept

The BIG-PLUS Spindle System is based on the most current available standards in ASME B5.50, JIS B6339 and DIN 69871. A conventional steep taper tool holder is supported on a reference diameter called the gauge line. On the contrary, a BIG-PLUS tool holder is supported on the flange face, which brings remarkable improvement to rigidity.

Increased Contact Diameter (Example of BT50)

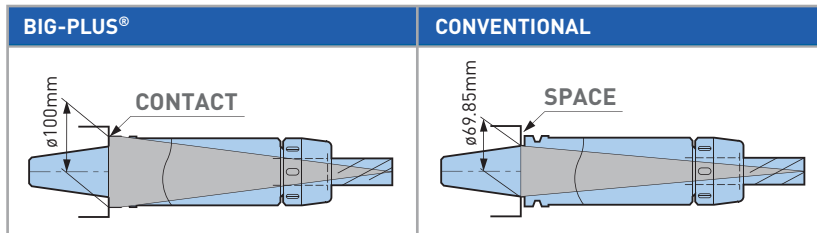

Taper No.	Conventional	BIG-PLUS
CV50	ø2.750	ø3.875
CV40	ø1.750	ø2.500
BT30	ø1.250	ø1.811

Perfect Interchangeability

BIG-PLUS tool holders can be used on existing standard machine spindles. Existing standard tool holders can also be used on BIG-PLUS spindles. In this case however, simultaneous contact cannot be attained. Although other simultaneous contact systems require exclusive new accessories, BIG-PLUS tooling uses existing accessories such as a tool presetter and tool holder fixture as it is based on a conventional steep taper shank. Further, it is not necessary to modify tool magazines and ATC devices of existing machines.

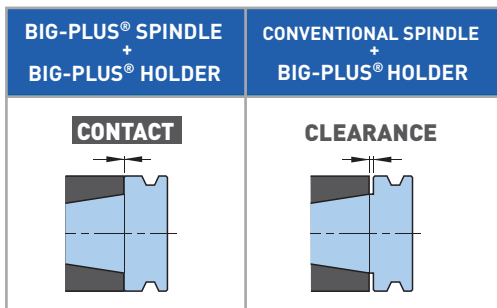

Existing Accessories Utilized

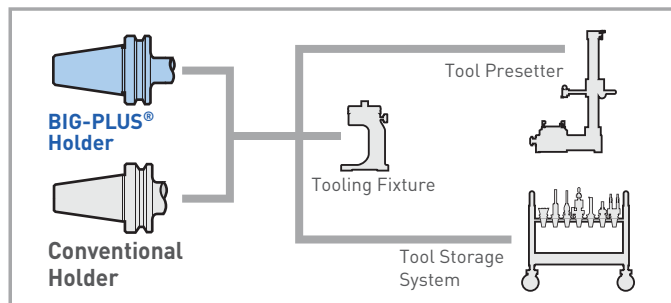

BIG-PLUS spindles have been adopted by licensed machine or spindle builders around the world under strictly controlled dimensions using BIG's Master Gauge. In order to protect the spindle or prevent possible accident, only use tool holders with the BIG-PLUS trademark.

Improvement of ATC Repeatability

The BIG-PLUS Spindle System assures the highest precision location of the tool holder in the spindle when using the ATC for loading tools as a result of the dual contact, which precisely positions the tool holder within 1 micron.

ATC Repeatability

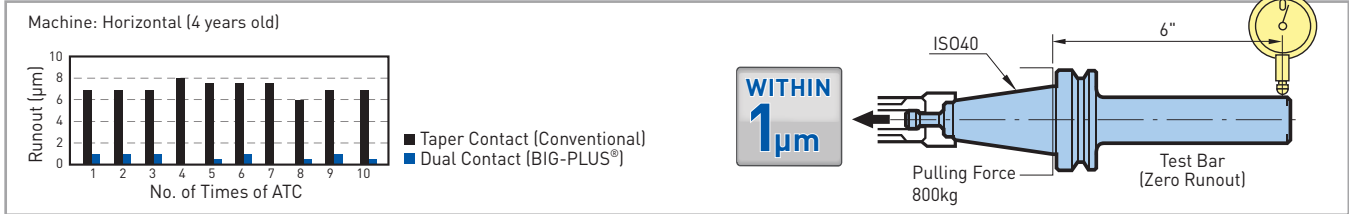

Minimized Deflection for Maximum Machining Accuracy & Superior Finish

With BIG-PLUS simultaneous contact, machining rigidity is greatly enhanced due to the larger contact diameter of the tool holder flange face. This larger face contact, combined with the taper contact, works together to resist deflection. With less deflection, greater machining accuracy and superior finish can be achieved.

Comparison of Deflection

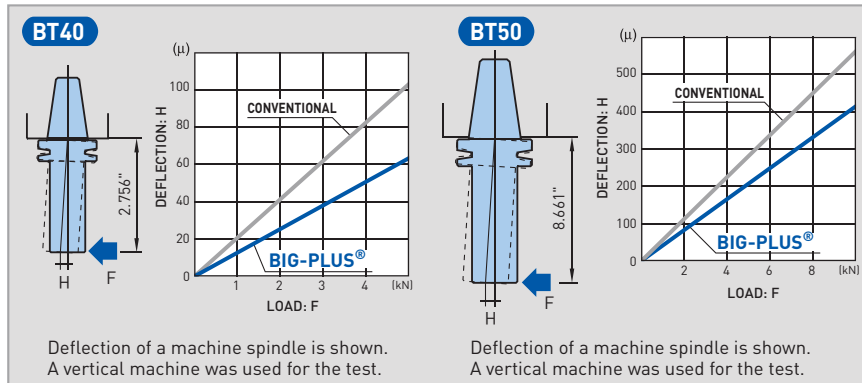

Strict Gauge Control

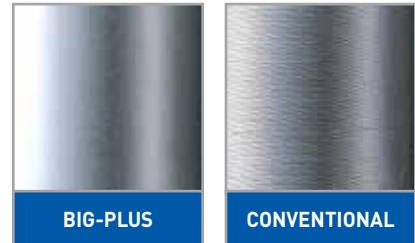

Cutting Conditions

Machine: 40 Taper (Horizontal Machining Center)
 Cutter: Face Mill ø5" (6 cutting edges)
 Work Material: A2017 Duralumin
 Cutting Depth: .094"

Strict Gauge Control

BIG-PLUS spindles produced by the licensed machine or spindle builders are strictly controlled in dimensions by the BIG original Master Gauge. Only the BIG-PLUS trademarked tool holders can achieve the optimal performance fully and safely.

Gauges for Machine Spindle



BIG-PLUS Spindle System Machine Builders

The BIG-PLUS Spindle System is offered by many of the world's leading manufacturers of machining centers. Some of the machine and spindle builders who have produced BIG-PLUS spindles are as follows:

ACCUWAY, **ADVANCED MACHINE**, ALEX-TECH, AMS, ANCA, AONO GIKEN, ARES, ASA TECH, AWEA, BERG SPANNTECHNIK, BOST, BROTHER, CERI, CHEVALIER, CHUO-SEIKI, CITIZEN, COLGAR, D.S.TECHNOLOGIE, DAH LIH, DAIYA SEIKI, DAITO, DIXI, DMC, DMG MORI SEIKI AD, DMG MORI SEIKI CO.,LTD., DOOSAN, **DYNAMAX**, EGURO, ENSHU, FADAL, FAMOT, FANUC, FEMCO, FIRST, FIRST, **FISCHER**, FOREST-LINÉ, FPT, FRANZ KESSLER, FUJI SEIKI, GIDDINGS & LEWIS, GMN, **GTI**, HARDINGE, HARTFORD, HEYLIGENSTADT, HISION, HNK, HOMMA, HORKOS, HOWA, HST, HURCO, HWACHEON, IBAG, IBARMIA INNOVATEK, IKEGAI, INOUE KOSOKU KIKAI, JOBS, JOHN FORD, JTEKT, JUNGWOO M.S., JYOTI, KARATS, KASHIFUJI, KASWIN, KENTURN, KIRA, KITAMURA, KIWA, KMT, KOMATSU NTC, KONDIA, KOYO, KPTEC, KURAKI, LAZZATI, MAG, MAGNIX, MAKINO, MAKINO SEIKI, MANDELLI, MATSUURA, MAZAK, MECTRON, MILLTRONICS, MITSUBISHI, MITSUBOSHI KOGYO, MITSUI SEIKI, MOTOKUBO, MTE, MYL, N.S.S, NACHI, NAKAMURA, NEO, NICOLÁS CORREA, NIIGATA, NIPPON BEARING, NISHIJIMAX, NISSIN-MFG, NOMURA, **NORTHLAND TOOL**, NSK, NUMEN, O-M, OBATAKE, OHTORI, OKK, OKUMA, OMLAT, OMY, PAMA, **PDS**, PIETRO CARNAGHI, PMC, QUASER, REIDEN, ROKU ROKU, ROYAL, RS TEC, SAJO, SEMA, SEMPUCO, **SETCO**, SHAN RONG, SHODA, SHW, SKG, SKODA, SMEC, SNK, SODICK, SORALUCE, SPINDER, SPINTEC, SPINTRUE, **SPS**, STARRAGHECKERT, STUDER, SUFENG, SUGINO, SUNWOO, **SUPERIOR SPINDLE SERVICE**, SWIFT, TAJMAC-ZPS, TAKAMAZ KIKAI KOUGYOU, TAKISAWA, TANABE, THETA, TONGTAI, TOS KURIM, TOS VARNSDORF, TOSHIBA, TOYO SEIKI, TSUDAKOMA, TSUGAMI, UGINT, UTSUNOMIYA, VICTOR TAICHUNG, VTEC, VYU CHENG, WALDRICH COBURG, WELE, WIA, YAMASAKI GIKEN, YAMASHINA SEIKI, YASDA, YASUNAGA, YCM, YU HUNG, ZAYER

[As of July 2018]

• Bold company names are North American licensed BIG-PLUS spindle rebuilders



HSK TOOLING SYSTEM

ISO 12164/DIN 69893/ASME B5.62

Selected materials and strict control of dimensional accuracy for the optimum quality. Wide range of standard holders to meet all production requirements.



AVAILABLE IN
HSK TYPE A/E/F
HSK SIZES
25/32/40/50/63/80/100/125

Premium Material Selection

Since HSK is a hollow taper shank, the material has a critical role for optimum performance. BIG uses carefully selected high grade alloy steels. Particularly, BIG uses die steel materials for HSK40 and smaller where the cross section of shank taper is very thin.

HSK Type	HSK Size					
	25	32	40	50	63	100
T	.043	.049	.076	.102	.137	.204

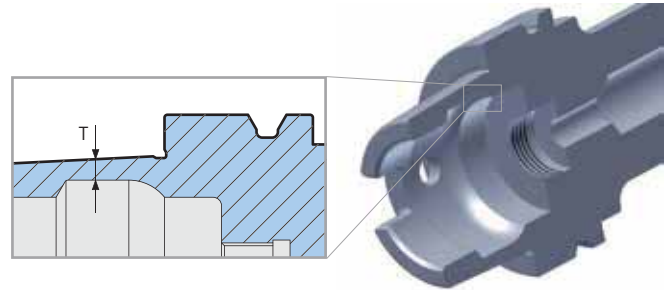

Drive Key Form

HSK Shanks according to Form A are designed to carry out torque transmission by the round shaped key-way at the end of the taper. Because of the importance of this round shaped geometry, BIG provides finishing of this feature after heat treatment.

Important Tool Retention Feature

Internal clamping of HSK tools is defined by the location of highly concentrated forces from the machine tool. Accuracy and position of this form will affect the rigidity, repeatability and precision of tool holders. BIG provides finish machining of this area after heat treatment.

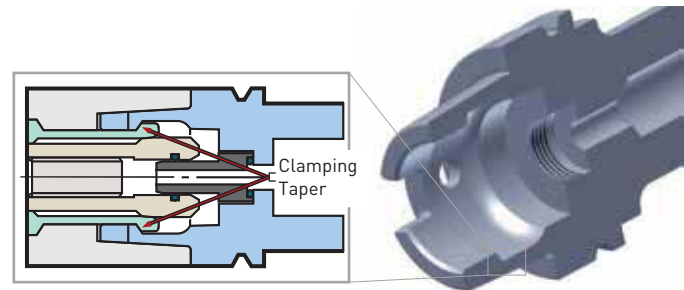

AVAILABLE IN
TURNING TOOLS
HSK FORM T
HSK-T63/T100 (ISO 12164-3)



BIG CAPTO

ISO 26623-1

A dual contact modular turning and rotating tool holder system that strengthens the performance of MTC's. The BIG CAPTO modular tooling system offers better efficiency, material selection and heat treatment.

* The trademark CAPTO is licensed from Sandvik Coromant

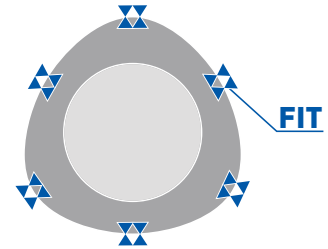

Excellent Repeatability & Runout

High repeatability is achieved due to the perfect fit of the polygon taper to drive spindle rotation. The combination of a self-centering 1:20 taper and the long taper edge assures stable runout accuracy.



Wider Range of Rotating BIG CAPTO Tooling than Any Other Provider

As a licensed manufacturer since 2002, BIG Daishowa through BIG KAISER offers a wider range of rotating BIG CAPTO tooling than any other provider. Extended reach collet chucks feature the world-class New Baby Collet system with less than 3 microns guaranteed accuracy at 4xD. Other solutions with BIG CAPTO include the MEGA ER GRIP, HYDRAULIC CHUCKS, the MEGA E CHUCK system, MEGA DOUBLE POWER CHUCKS for the highest rigidity while end milling, MEGA MICRO CHUCKS with the world's smallest collet system for reaching into tight areas, and many more.

45° TILT STYLE TYPE S

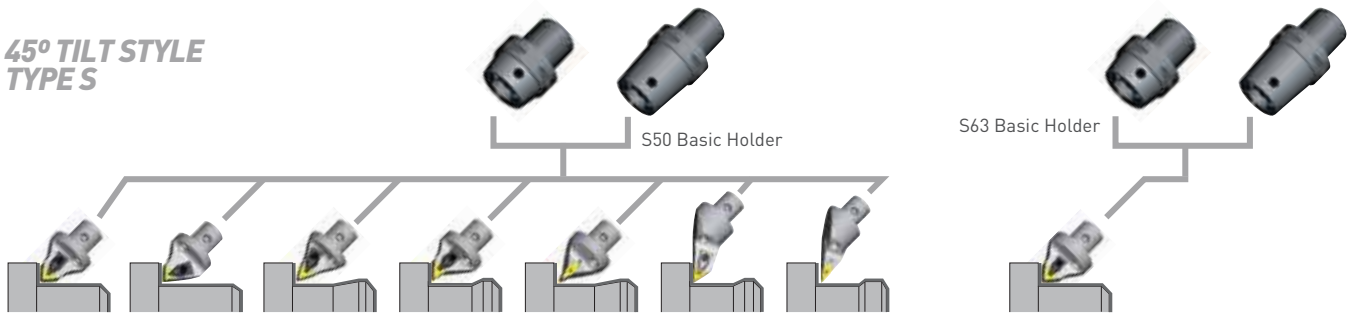

90° RIGHT ANGLE STYLE TYPE F

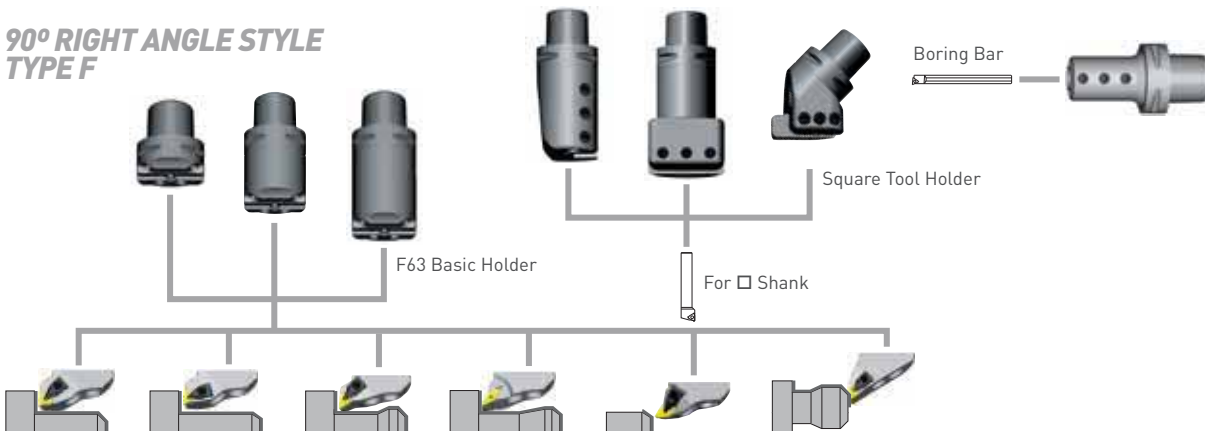



CK, CKB & CKN

Various Connections — One System

Based on a cylindrical connection with radial locking screw, the world-famous modular precision tool system BIG KAISER has continuously been improved over the years, and has adapted to customer's needs and the increases in machine tool performance. Compatibility to existing tools has always been a requirement for newer designs. This means that all BIG KAISER connections are almost 100% compatible, and all the components are kept in stock.



CKB CONNECTION: Highly Efficient And Easy To Handle

The modular components are clamped with the lateral locking screw (CK-screw). The floating cross bolt is automatically centered in the trapezoid-shaped recesses in the mating part and ensures an absolutely uniform distribution of the torque forces.

- Simple, efficient operation -no special equipment or tools needed
- Maximum rigidity due to high preloading forces and large contact surfaces
- Precise cutting edge location even when using several adapters
- High interchange accuracy, maximum radial change error is .0001"

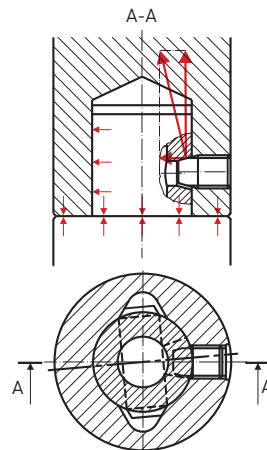

CKN CONNECTION: for lightweight and high performance tools

Based on a 3-screw connection and a male pilot with 3 partial slits, the CKN connection is designed for lightweight and high performance tools. The main components for the lightweight program are double connector couplings made of steel and extension tubes made of aluminium. The high performance program for enhanced radial stiffness is entirely made of steel components.

- Double connector coupling made of steel and aluminium extensions for the transmission of high torques
- Weight reductions up to 50% and equal cutting performance, compared to tool combinations made of steel
- Reduced weight allows easier handling and eliminates manual tool change in many cases
- Max. rigidity of the tool connection due to high clamping force and expansion of the slotted tool connector
- Vibration damping due to the use of different materials

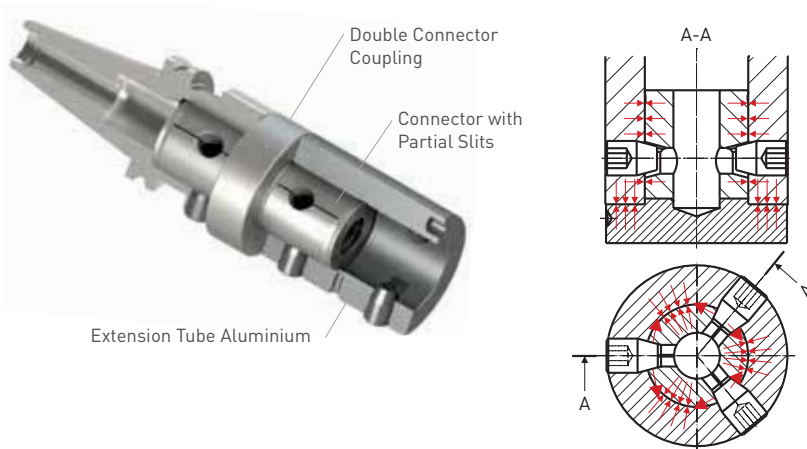

Compatibility CKN - CKB

For compatibility reasons, the CKN shanks will be delivered with only one CK screw. For CKN assemblies, the remaining two CK screws will be supplied with the mating component having the male CKN connection.





MEGA CHUCK[®] SERIES

Wide variety of collets and chuck bodies to cover all high-speed ultra-precision machining applications.

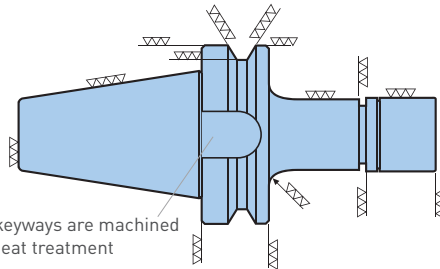

Precision Ground and Balanced for High Speed Machining

MEGA CHUCKS are micro-mirror ground-finished on all surfaces to assure perfect concentricity for high speed machining. The drive keyway is machined after heat treatment.

Notch-Free Design MEGA NUT Prevents Vibration & Reduces Noise

Vibration at high speeds is eliminated with the use of notch-free nuts, which offer superior balance and concentricity. This ideal nut design not only reduces whistling noise and splattering coolant, but also assures increased strength of the nut itself.

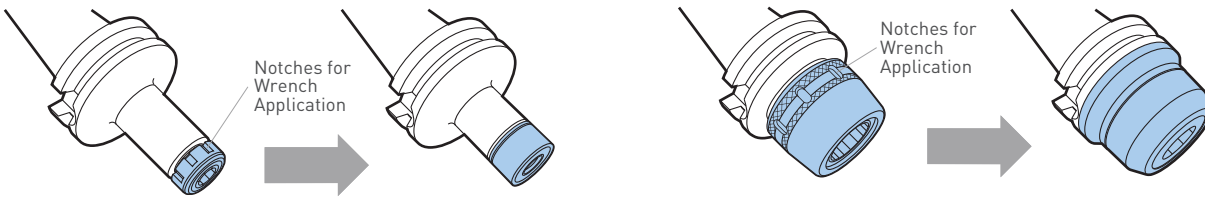

Smooth Tightening Operation by Ratchet Function

Easy & Firm Clamping by the MEGA WRENCH

The unique MEGA WRENCH has a one-way clutch system with roller bearings and a ratchet function which is capable of safely and evenly applying force to the entire nut periphery.



A Variety of MEGA CHUCKS Available

**MAX
40,000
RPM**



MEGA MICRO CHUCK



MEGA NEW BABY CHUCK



MEGA ER GRIP



MEGA E CHUCK



MEGA DOUBLE POWER CHUCK

**MAX
30,000
RPM**

Collet Chuck Series	Taper Type																		
	BCV		BBT			HSK										BIG CAPTO			
	40	50	30	40	50	A40	A50	A63	A100	A125	E25	E32	E40	E50	F63	C4	C5	C6	C8
MEGA3S	•		•	•		•	•	•			•	•	•	•			•	•	
MEGA4S	•		•	•		•	•	•			•	•	•	•			•	•	
MEGA6S	•		•	•		•	•	•			•	•	•	•			•	•	
MEGA8S	•		•	•				•											
MEGA6N	•	•	•	•	•	•	•	•	•		•	•	•	•	•	•	•	•	•
MEGA8N	•	•	•	•	•	•	•	•	•		•	•	•	•	•	•	•	•	•
MEGA10N	•	•	•	•	•	•	•	•	•		•	•	•	•	•	•	•	•	•
MEGA13N	•	•	•	•	•	•	•	•	•			•	•	•	•	•	•	•	•
MEGA16N	•	•	•	•	•	•	•	•	•				•	•	•	•	•	•	•
MEGA20N	•	•	•	•	•	•	•	•	•					•	•	•	•	•	•
MEGA25N	•	•	•	•	•		•	•	•										
MEGAER11	•																		
MEGAER16	•	•	•					•	•	•						•	•	•	
MEGAER20	•	•	•					•	•							•	•	•	
MEGAER25	•	•	•					•	•							•	•	•	
MEGAER32	•	•	•					•	•	•							•	•	
MEGA6E	•		•	•	•	•	•	•	•				•	•	•	•	•	•	•
MEGA8E	•		•	•	•	•	•	•	•				•	•	•	•	•	•	•
MEGA10E	•		•	•	•	•	•	•	•				•	•	•	•	•	•	•
MEGA13E	•	•	•	•	•	•	•	•	•				•	•	•	•	•	•	•

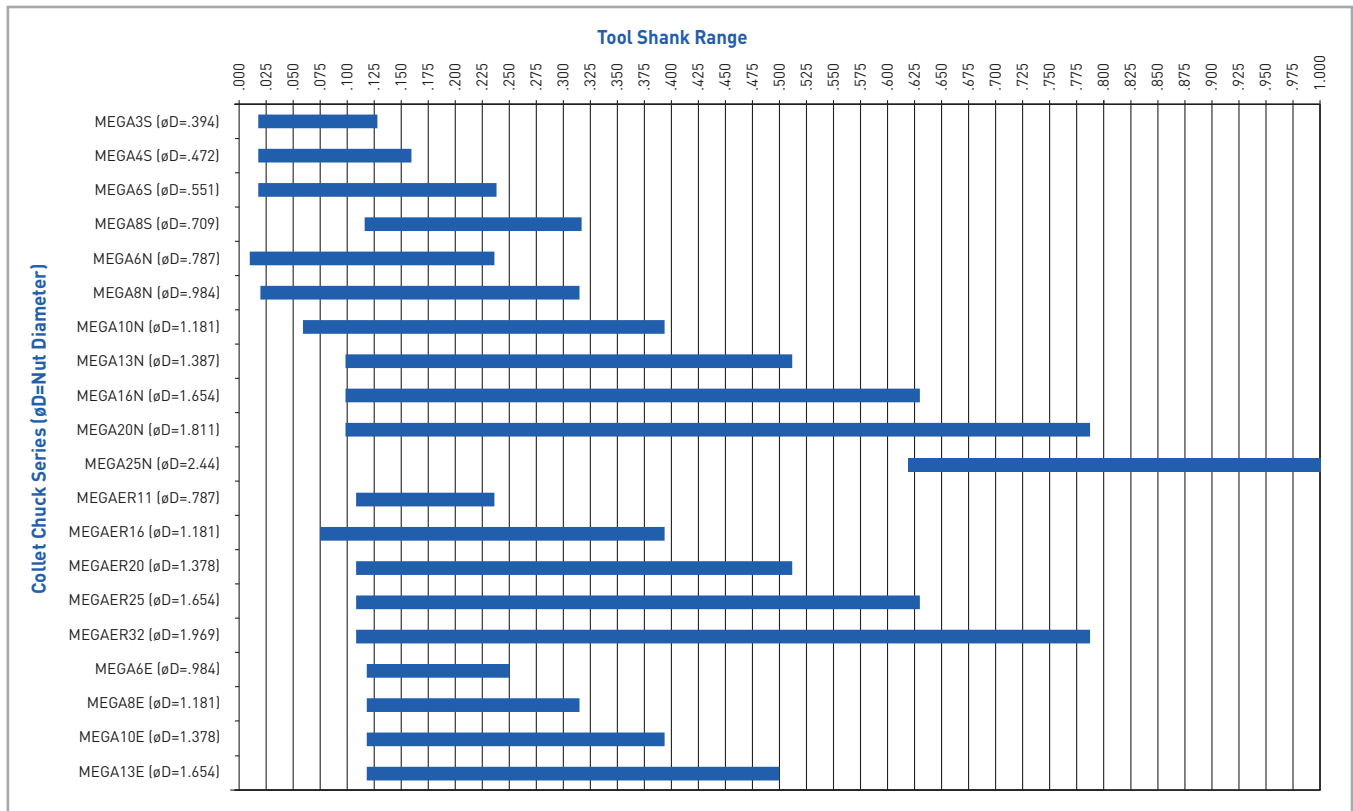



MEGA MICRO CHUCK®

CLAMPING RANGE: \varnothing .018"-.317" (\varnothing .45-8.05mm)

Extremely slim design of body and nut provides superior balance and concentricity and is ideal for reaching into confined areas.

**MAX
50,000
RPM**

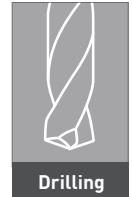

BIG-PLUS
SPINDLE SYSTEM
DUAL CONTACT

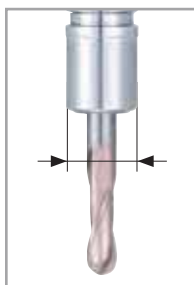

Extremely Slim Design Nut \varnothing .394"/.472"/.551"/.709" 3S/4S/6S/8S Type

Slim design avoids interference. Ideal for small mold making combining speed and high precision capability.

\varnothing .394"
FULL SCALE
(3S TYPE)



NEW!
Sealed Nut for Through-Tool Coolant (available for 6S & 8S only)



High Concentricity MEGA MICRO COLLET

**HIGH
PRECISION**

100% concentricity inspection. Guaranteed runout within .00004" at the nose. Available for higher precision in steps of \varnothing .004" (\varnothing .1mm)

Strict Gauge Control

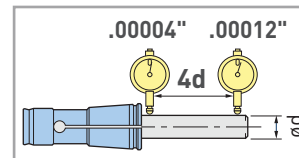

All BIG Collets are AA Grade and inspected twice for accuracy

A Variety of Interfaces for High Speed Machining

STRAIGHT TYPE

Where Access is Restricted

TAPER TYPE

For Increased Rigidity

STRAIGHT SHANK TYPE

For Increased Versatility

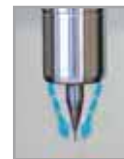

20,000 rpm/1.5MPa

Up to 35% higher tool lifetime compared to standard nut

MEGA MICRO COOLANT NUT (PAT. PENDING)

For MEGA MICRO CHUCK 6S provides a more efficient coolant supply for micro cutting tools. Ideal design for high-speed micro machining up to \varnothing 6mm.

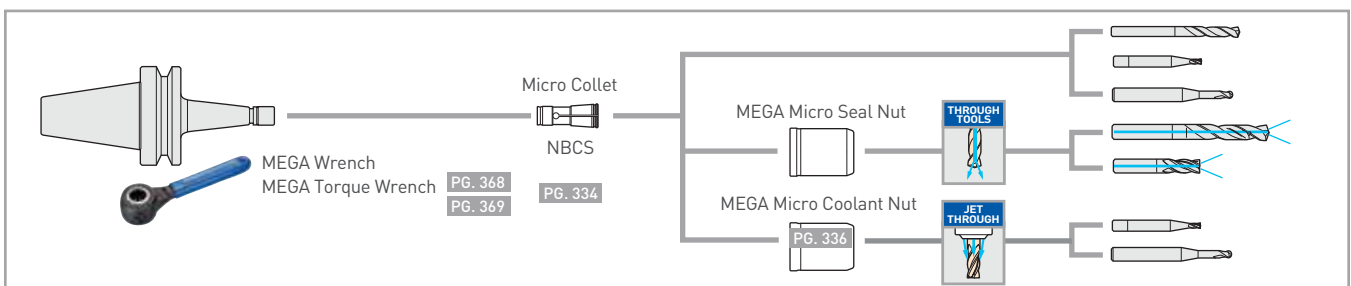

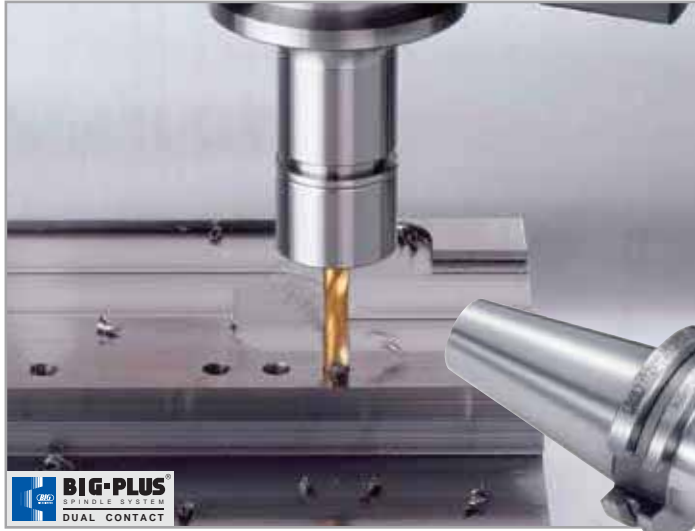

MEGA NEW BABY CHUCK®

CLAMPING RANGE: \varnothing .010" - 1.000" (\varnothing .25mm - 25.4mm)

High speed design, offered in six different collet series sizes. Utilizes ultra precision New Baby Collets which guarantee a runout at the collet nose of less than .00004".

**MAX
50,000
RPM**

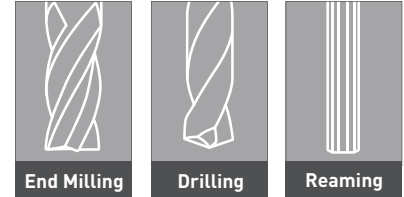

CAUTION! Tool Extension Less Rigid

CAUTION! Tool Extension Less Rigid

Maximum Performance!

IDEAL CONDITION!

Wide Range Available as Standard

Ideal length and diameter of the holder is the key to precision machining. If selection is limited, an increased tool extension reduces performance.

High Precision Collet, Close to Submicron NEW BABY COLLET

The NBC collet is 100% inspected to guarantee accuracy. Material, production, heat treatment... everything is selected for precision.

HIGH PRECISION

Two Way Coolant Sealed Collet Nut MEGA PERFECT SEAL

- Standard NBC Collet is used
- High dust resistance



Strict Gauge Control

1 μ m AT COLLET NOSE

3 μ m at end of test bar

All BIG Collets are AA Grade and inspected twice for accuracy

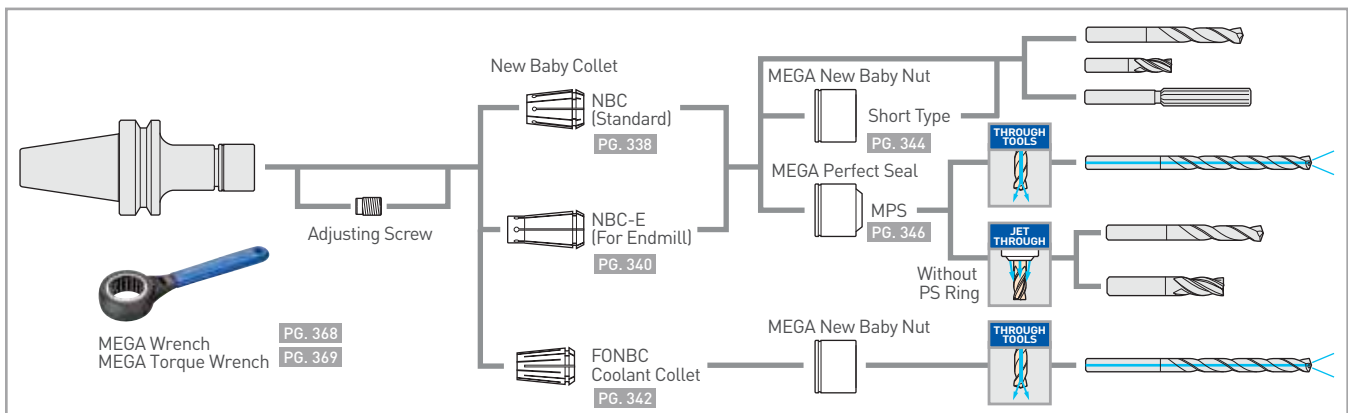



MEGA ER[®] GRIP

CLAMPING RANGE: ϕ .075" - .787" (ϕ 1.9mm-20mm)

High precision collet, nut and body that outperforms standard ER systems. Reliable and stable runout accuracy will also tremendously contribute to improving machining capability and cost reduction.

MAX
35,000
RPM

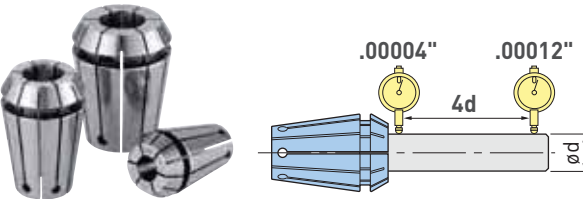
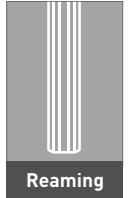

ER Collet with the Best Runout Accuracy in the World

Measurement standards in accordance with DIN 6499 and ISO 15488

Clamping Range	DIN/ISO		BIG BIG DASHOWA MEGA ER [®] GRIP
	Class 1	Class 2	
ϕ .079 - ϕ .394	0.0004	0.0006	Within .00012
ϕ .394 - ϕ .787	0.0006	0.0008	

Variety Of Nut Selection

Two type of ER nut as well as sealing nut offer the most suitable solution for your demand. These nut can also be used for conventional ER chuck models.

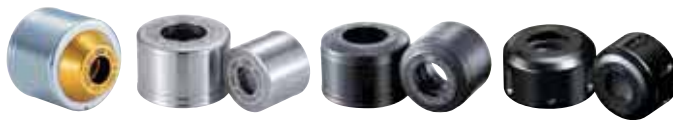

MEGA ER PERFECT SEAL

MEGA ER NUT

MEGA ER SOLID NUT

ER NUT

High Rigidity Body that Increases Collet Contact Area

By increasing the contact length of the internal taper of chuck bodies, the undesired overhang of the collet is reduced. This modification of the standard improves 3 of the most important requirements for the collet chuck: rigidity, runout accuracy and clamping force. (Conventional DIN collets can also be used)

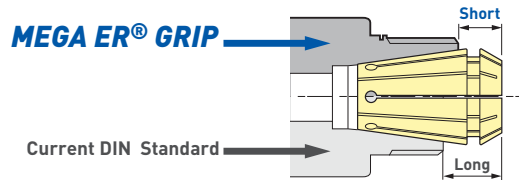

THROUGH TOOLS

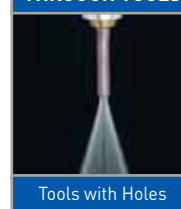

JET THROUGH

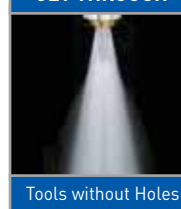

2-Way Coolant Supply

Sealed nut MEGA PERFECT SEAL offers 2-coolant solutions.

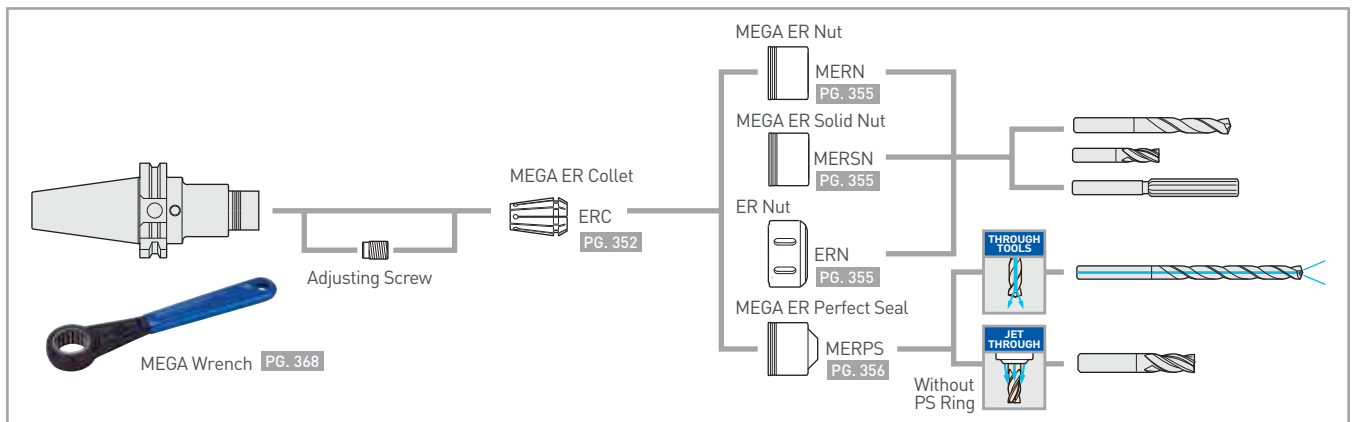



MEGA E CHUCK®

CLAMPING RANGE: \varnothing .125"-.500" (\varnothing 3mm-12mm)

Collet chuck designed exclusively for end milling up to \varnothing .500" with high concentricity & rigidity.

**MAX
40,000
RPM**

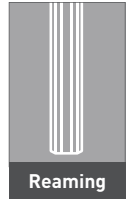

High Concentricity MEGA E COLLET

100% concentricity inspection. Runout within $1\mu\text{m}$ at nose is guaranteed.

**HIGH
PRECISION**

Guaranteed Max Runout

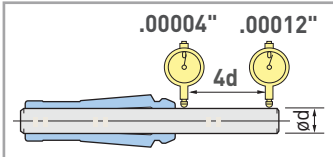

All BIG Collets are AA Grade and inspected twice for accuracy

- Use only cutting tool shanks with the exact same diameter as the collet bore diameter.

Sealed Collet Nut MEGA E PERFECT SEAL

Sealed collet nut to supply coolant reliably through cutting tool. Ideal for burnishing drills and reamers due to the extended gripping length of the MEGA E CHUCK.



**MAX COOLANT
PRESSURE
1,000
PSI**

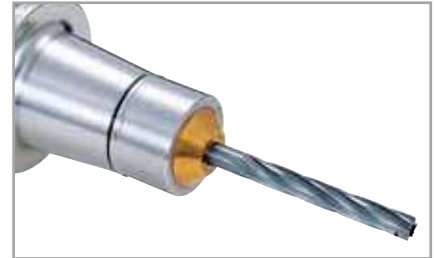

High Gripping Strength Collet

Gripping force is an important element for end milling with a collet chuck. The long gripping length of the collet in the MEGA E series provides a powerful gripping force. The shallower taper of the collet improves concentricity in order to achieve better surface finishes and longer cutting tool life.

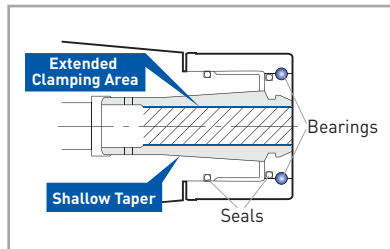

Substantial and Tapered Body Design

Thick body eliminates chatter and deflection. Tapered extension provides the rigidity to prevent vibration.

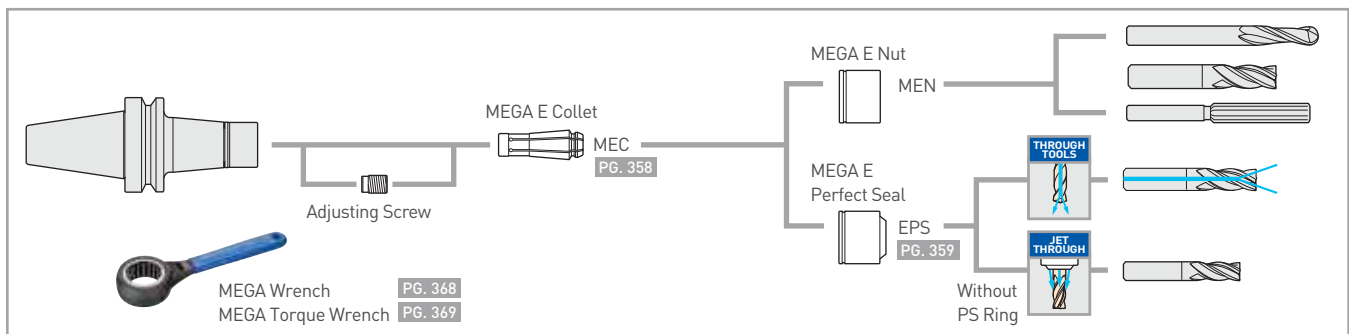
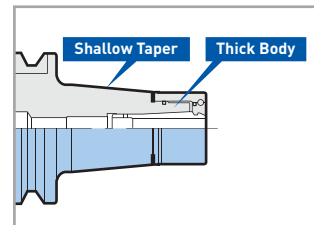



MEGA DOUBLE POWER CHUCK®

CLAMPING RANGE: \varnothing .625" - \varnothing 1.500" (\varnothing 16mm-50mm)

High rigidity design for heavy cutting. Flange contacting nut and simultaneous taper & flange contact assure highest rigidity.

**MAX
30,000
RPM**

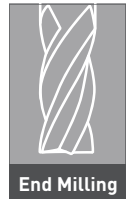

Stabilizing Contact Between Flange & Nut Provides Exceptional Rigidity

The expanded contact diameter of the nut of the MEGA DOUBLE POWER CHUCK to the flange provides the highest rigidity as if the chuck and nut were one solid piece. This superior rigidity assures heavier duty machining without chatter.

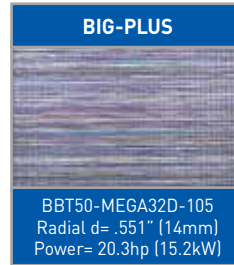
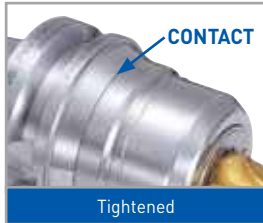

Cutting Conditions

Cutter: Coated Carbide End Mill \varnothing 32mm, 4-flutes
Work Material: A36 Steel (JIS SS400)
Cutting Speed: 925 SFM (282 m/min)
Spindle Speed: 2,800 RPM
Feed Rate: 44 IPM (1,120 mm/min)

Secure Coolant Supply

Two types are individually designed for the most effective coolant supply.

- Improved surface finish
- Smoother chip evacuation
- Extended tool life
- Cooling & lubrication of tools

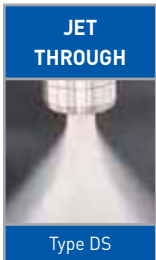

A Variety of Straight Collets Available

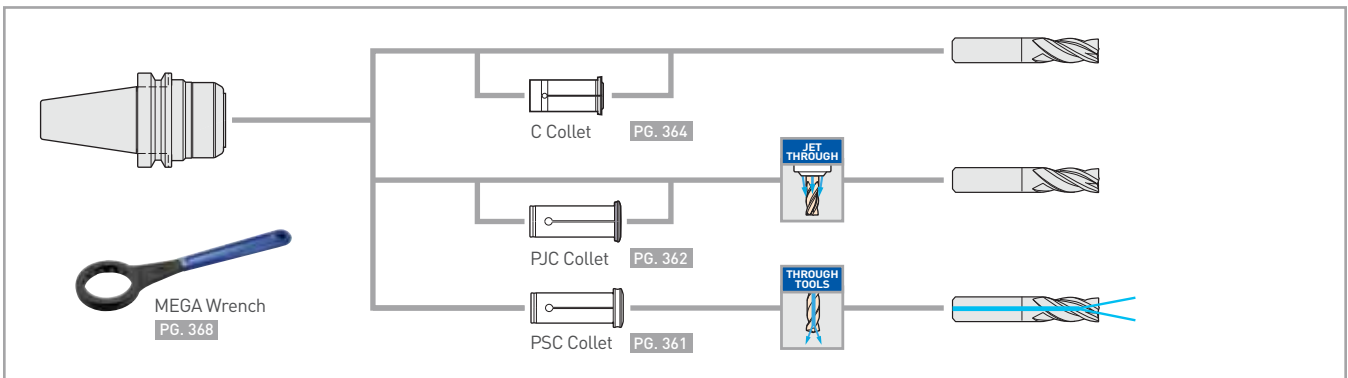



MEGA PERFECT GRIP

CLAMPING RANGE: \varnothing .750"-1.250" (\varnothing 16mm-32mm)

Features 100% Security Against End Mill Slip or Pullout Under Any Torque Load!

- A unique lock mechanism using a Key Grip prevents the slip and pullout of the tool during heavy cutting.
- By simply using straight shank cutters with a Weldon flat, no special cutter is required. If your cutter doesn't have a flat, adding your own flat according to the general Weldon standard allows its use in the MEGA PERFECT GRIP.

Simple, Easy Handling with Secure Clamping

1. Place the exclusive Key Grip into the Weldon flat of the end mill shank.
2. Insert the end mill with the Key Grip in alignment with one of the three Key Grip grooves inside the milling chuck.
3. Rotate the end mill approximately 20° clockwise until the Key Grip stops securely against the stopper pin.
4. Finish clamping the tool until the clamping nut contacts the positive stop of the chuck body.

Non-Pullout Mechanism

The Key Grip engages in the groove of the chuck body to ensure no tool pullout.

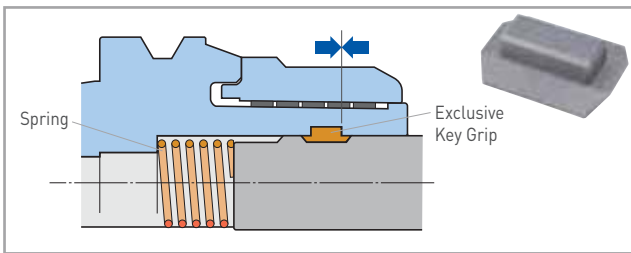

Complete Fit of Nut and Body

Tightening the nut achieves dual contact between the nut and body for rigidity close to that of an integral cutter.

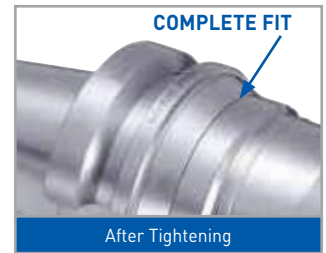

Non-Slip Mechanism

The Key Grip maintains contact with the stopper pin to prevent any slip under high torque.

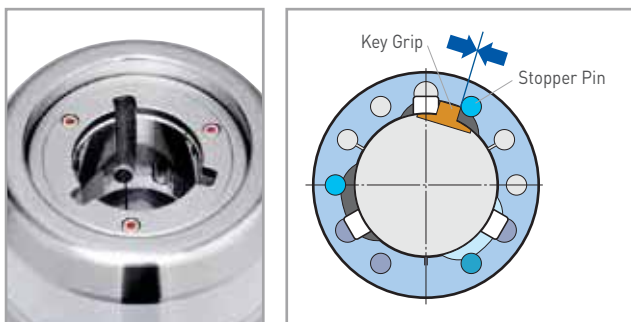

Flood Jet-Through Coolant

The Key Grip grooves provide channels for high volume coolant to the cutter.

Effective end milling of HRSA's requires a high volume of coolant to the cutting edge to dissipate heat and aid in the removal of chips.





NEW BABY CHUCK

CLAMPING RANGE: ϕ .010"-.787" (ϕ .25mm-20mm)

High-precision collet chuck system with an accuracy of 1 micron at nose.

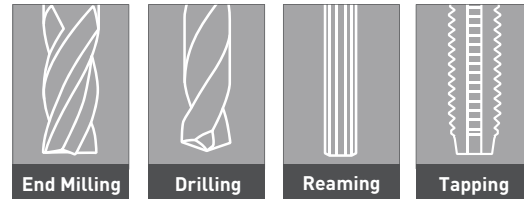

High Precision Collet, Close to Submicron NEW BABY COLLET

HIGH PRECISION

The NBC collet is 100% inspected to guarantee accuracy. Material, production, heat treatment... everything is selected for precision.

Strict Gauge Control

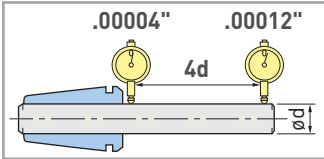

All BIG Collets are AA Grade and inspected twice for accuracy

Ensures High Accuracy

The double effect of precision threads finished after heat treatment and the smooth tightening of the thrust balls without torsion on the collet achieves stable high-precision collet tightening. Furthermore, the mechanism acts to prevent the thrust ball from jumping out due to centrifugal force generated by high speed rotation, promising stable machining.

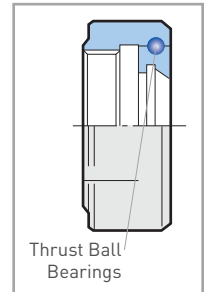

Coolant Through Tools (BPS)

The sealing functionality of the PERFECT SEAL means that the higher the coolant pressure is, the tighter the PS Ring adheres to the tool shank, increasing the sealing effect. The secure sealing function allows coolant to be securely supplied to the tip for high-pressure machining in high-speed applications. A sealing nut is used with a standard collet.

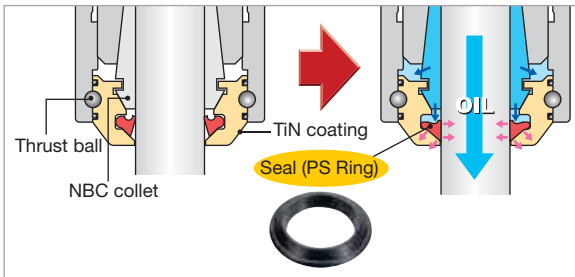

Coolant Methods to Suit the Application BABY PERFECT SEAL

A coolant nut with oil sealing functionality.

Removing the internal PS Ring allows jet-through coolant supply.

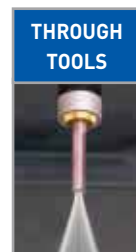

MAX COOLANT PRESSURE 1,000 PSI

The runout accuracy heavily affects finish quality and tool life. For holding an end mill, we recommend the use of an E Collet.



NEW Hi-POWER MILLING CHUCK

CLAMPING RANGE: ϕ .500" - 1.500" (ϕ 12mm-42mm)

Highly rigid chuck for resistance against chatter. Supports end milling with its heavy duty gripping force and high runout accuracy.

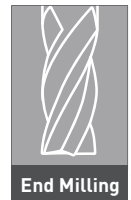

Reliable Slit Design Ensures High Accuracy

A unique BIG slit shape is adopted to achieve both the essential runout accuracy and gripping force which are the key elements of a milling chuck. Stable clamping is possible due to sufficient elastic deformation and the ability to remove oil film from the tool shank.

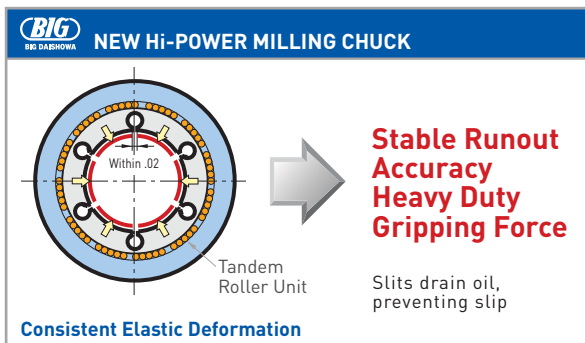

The Milling Chuck is Also Ideal as a Basic Holder

Allows the reliable use of straight collets as well as boring bars, arbors such as face milling cutters.

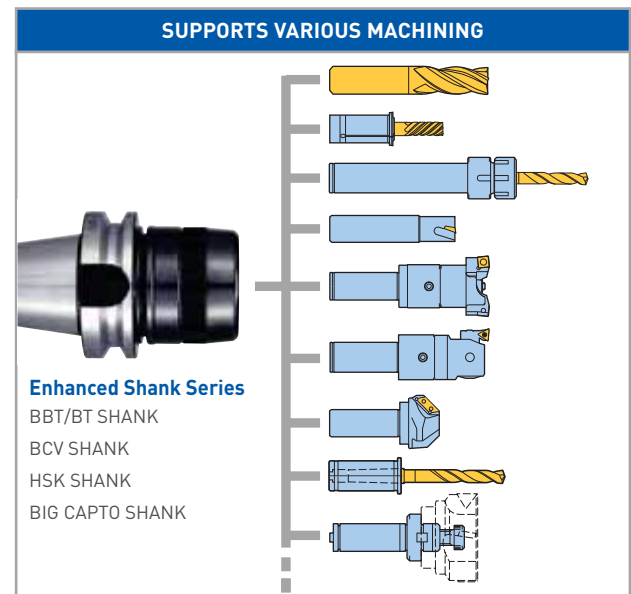

Reliable Slit Design Ensures High Accuracy

CLAMPING DIAMETER: ϕ 12mm & 1/2"

NEW!

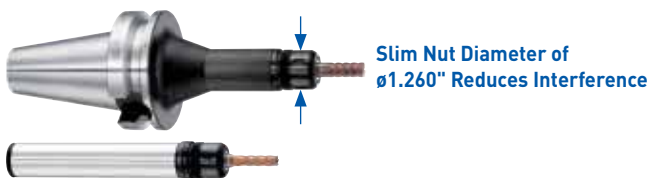

Diameter slimmer than collet chucks

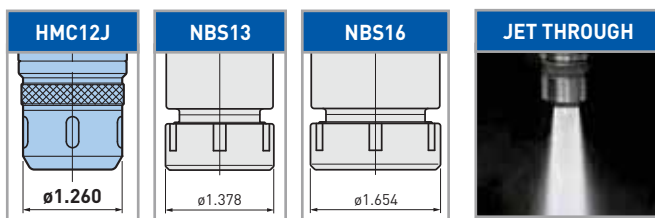

Runout Adjustable RA Holder

Simple Structure Allows for Easy Adjustment of Runout Accuracy!

Compensates for increased runout of machine tool spindles caused by extended use. Simple structure allows for easy adjustment in the machine.

- Consistent hole diameter
- Improved surface roughness
- Increased tool life



HYDRAULIC CHUCK

CLAMPING RANGE: ϕ .125"-1.250" (ϕ 3mm-32mm)

For high precision machining. Ideal tool holders for machining processes that require high accuracy such as drills, reamers, ball mills, end mills, diamond reamers and grinding tools.

**MAX
40,000
RPM**

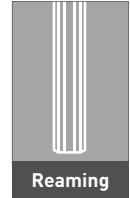

A Wide Variety of Clamping Diameters & Projections Available

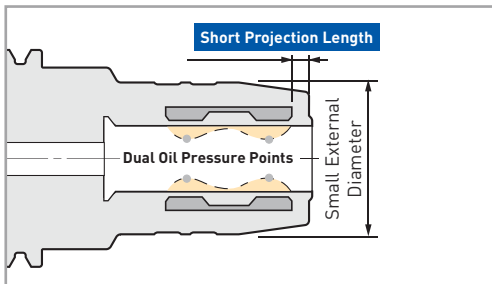

Internal structure with increased accuracy and rigidity

The integrated structure of the body and clamp sleeve gives greater rigidity and achieves better accuracy compared to the traditional two-part construction sealed with O-rings. 2-point tightening with dual hydraulic chambers and a short overhang area where the tool is not clamped give improved runout accuracy.

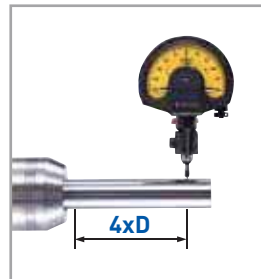

Runout Accuracy Less Than .00012"

High precision runout accuracy less than .00012" at 4xD improves the workpiece surface finish and extends tool life.

**HIGH RUNOUT
ACCURACY
<3 μ m**



Easy Clamping with 1 Wrench

The cutting tool can be clamped or unclamped easily and securely with just 1 wrench.

Allowable Shank Tolerance of Cutting Tools (h6)

REFERENCE INFORMATION "h6" INCH SERIES		REFERENCE INFORMATION "h6" METRIC SERIES	
Cutting Tool Shank ϕ	Allowable Tolerance	Cutting Tool Shank ϕ	Allowable Tolerance (μ m)
1/8, 1/4, 3/8	+0, -.00035	3, 4, 6, 8, 10mm	+0, -8 μ m
1/2, 5/8	+0, -.00043	12, 14, 16, 18mm	+0, -11 μ m
3/4, 1, 1 1/4	+0, -.0005	20, 25, 32mm	+0, -13 μ m



**Meets Diverse
Machining Applications!
Abundant Lineup In Length
And Clamping Diameter!**

SUPER SLIM TYPE

MIN. BODY DIAMETER .551"

Slim design eliminates interference. Ideal for high precision 5 axis machining.



**MAX
60,000
RPM**



HSK-E25/E32/E40/F63 Series Ultra-Compact and High Precision

Hydraulic chuck suitable for small machining centers.



**PREBALANCING
HSK-E25
<.5G.MM**



Cylindrical Shank Series

High precision cylindrical shank hydraulic chuck suitable for solving interference problems.



JET THROUGH TYPE

MIN. BODY DIAMETER .79"

Securely supplies coolant or oil mist to the tool periphery. Delivers outstanding results with high accuracy finishing in 5-axis machines.



**MAX
35,000
RPM**

Coolant Hole at Nose Supplies Coolant

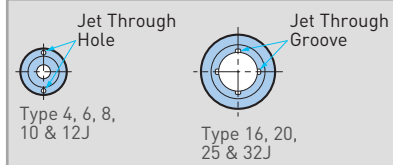

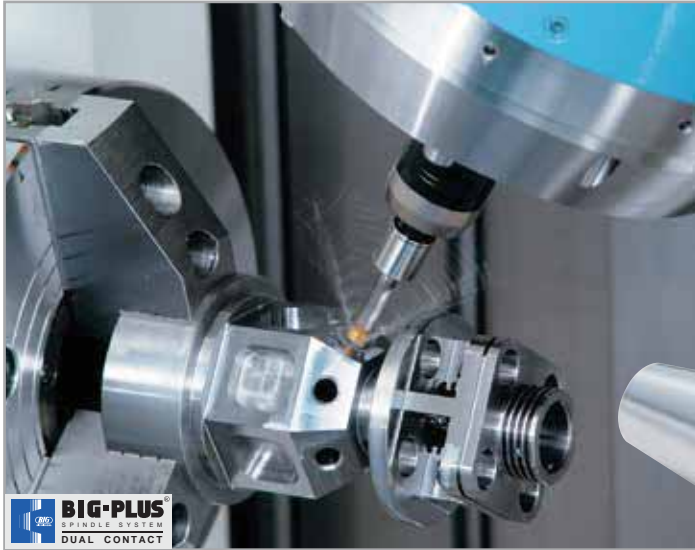

MEGA SYNCHRO[®] Tapping Holder

TAPPING RANGE: ANSI: NO.0-NPT1", JIS/DIN/ISO: M1-M36

Tool holder for rigid tapping compensates for synchronization errors during rigid tapping. Improves thread quality and tool life by reducing thrust loads caused by synchronization errors up to 90%.

* Patent is licensed from EMUGE

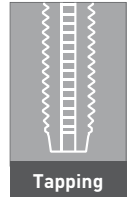

54 Body Models and 276 Tap Holder Models are Available

Large tap series achieves a maximum of NPT1". An extensive variety of bodies suitable for many spindle types. Short, middle & long tap holders are standardized to cover between No.6 and NPT1" (M2 and M36). The slim design avoids interference.



Secure Drive

The body and Tap Holder are fixed with a drive key in the rotation direction as well as the square of the tap.

THROUGH TOOLS



Coolant is Supplied Through Both the Tool and Slits of the Tap Holder

JET THROUGH



Coolant is Supplied Through Slits of the Tap Holder

Coolant Through Center Capability for All Models

Coolant is supplied both through the tool and to the tool periphery simultaneously.



BIG MEGA SYNCHRO tapping holder compensates for synchronization errors with any type of tap.
Minimized thrust load to both the tap and workpiece improves thread quality and tap life.

Load To Tap

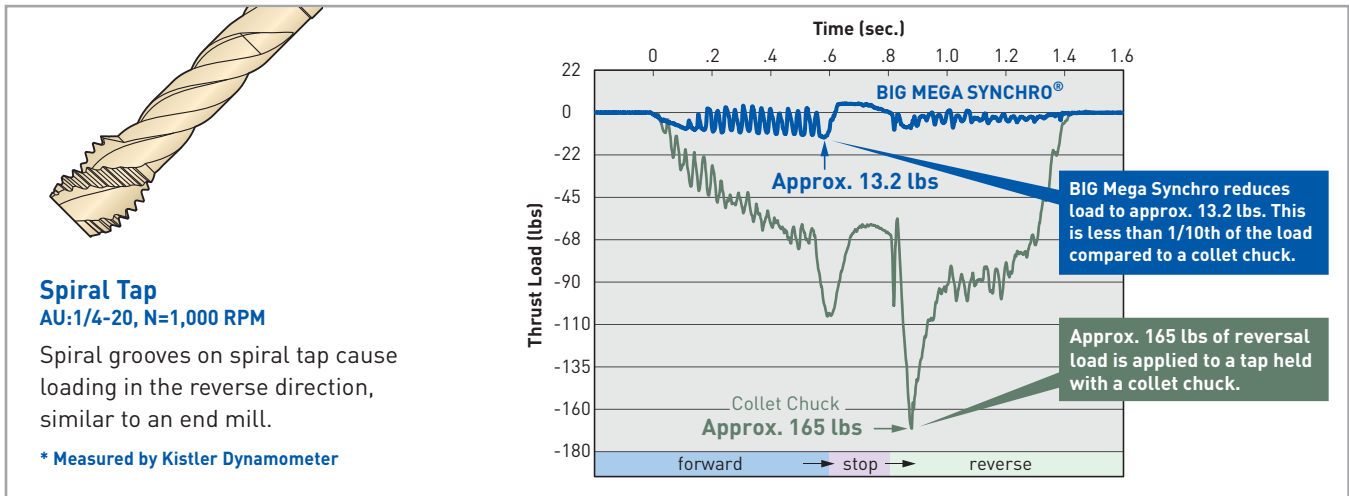

Cutting Conditions

Spiral Tap
 No.10-24
 Material: 4130

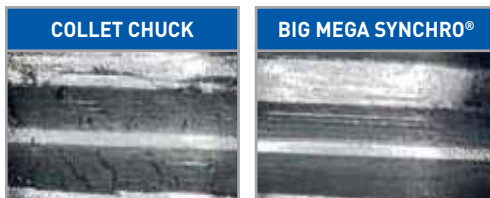

Comparison of Surface Finish

Tapping of exotic materials tends to cause a compressed burr on the thread surface. BIG MEGA SYNCHRO compensates for synchronization errors and minimizes the cutting load. Fine surface finish of threads is achieved.

PATENT #
9446463

MGT3

For Small Tap

Tapping Range: ANSI: No.0-No.6, JIS/DIN/ISO: M1-M3

Eliminating synchronization errors and minimizing dynamic runout at high speeds provides stable thread quality and extended tool life.

- BBT Shank
- HSK Shank
- Cylindrical Shank
- N/C Lathe Tooling



MEGA MICRO NUT

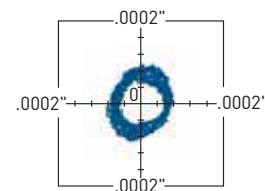

Dynamic Runout Accuracy Within .0002" (5µm) Even at 5,000 RPM

Plotted position of a test bar (at .630" distance on .157" diameter)



CK MODULAR BORING SYSTEM

Supports various applications from rough to finish boring with a large assortment of boring heads and accessories. Secure contact using a single wrench.



Secure Contact Using a Single Wrench! The Simplest Modular Boring Clamping System

The CK modular system is a simple method for securely and powerfully clamping multiple components with a single wrench.

Moreover, even if the same boring head is repeatedly attached and removed, the cutting edge position does not vary by 2 microns (.00008"). This accurate clamping allows boring diameter setup to be done with a boring head only, increasing the machine utilization and drastically reducing labor.

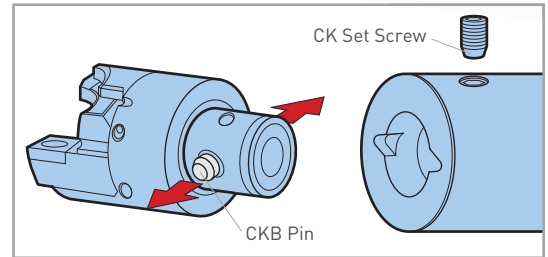
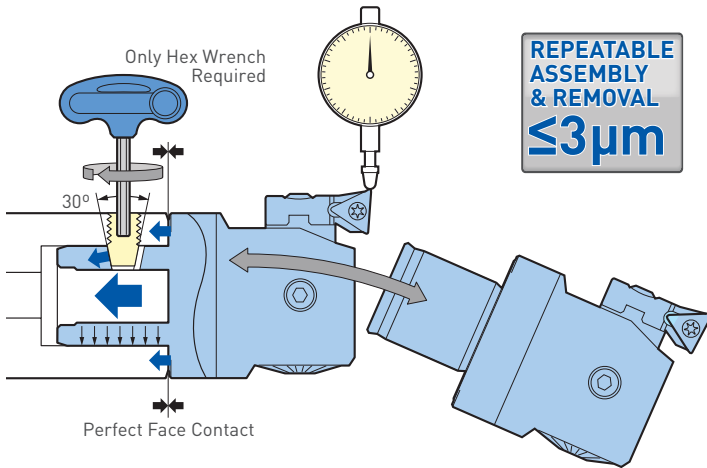

Safe Structure at High Torque

Adopts a proprietary CKB pin for high cutting torque. The CKB pin is of floating type which gives it good horizontal balance, dampening cutting torque and making it possible to withstand heavy duty torque.

Rapid Adaptation To Special Tools

Modular system that can be used to assemble special tools with standard items, allowing flexible compatibility.

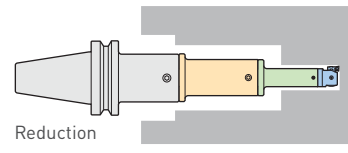
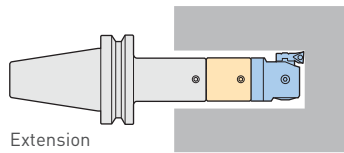
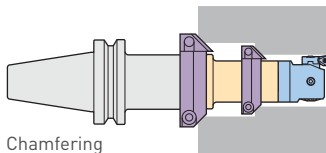



SERIES 319 SW

Rough Boring Heads

The short and compact design of the components combined with a positive and friction locked connection between the tool body and insert holders provide maximum rigidity and highest cutting performance.



MW 'MINI' TWIN ROUGH BORING TOOL **NEW!**

RANGE: $\phi.630''$ -.827" ($\phi 16-21\text{mm}$)

Adjustable twin cutter boring tool on a $\phi 20\text{mm}$ shank. Ideal solution for rough and semi-finish boring of small die cast holes.



AVAILABLE IN ALUMINUM FOR REDUCED WEIGHT

SW 319 x CKB1-CKB7 & CKN6-CKN7

RANGE: $\phi.787''$ -8.000"

Designed with ultimate performance and versatility in mind. Balanced or stepped cutting by simply switching mounting locations of the insert holders which feature varied heights!

Accessory Insert Holders for Chamfering & Back Boring

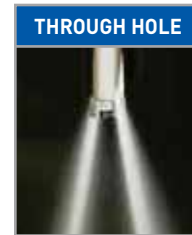
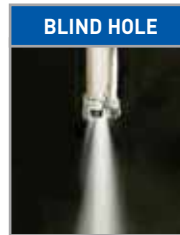
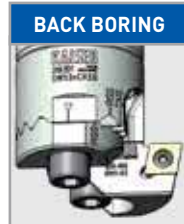
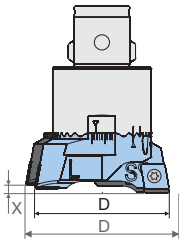

Center-Through

In blind hole situations, center-through coolant aids in chip evacuation. The coolant hole can be closed by the stop screw when required.



SERIES 315 TWN

Rough Boring Heads

RANGE: $\phi.787''$ -8.000"

Insert holders and head feature triple-contact precision and ground mating surfaces, greatly increasing the rigidity. For stable boring even in high feed, heavy duty operations. No variable insert height.

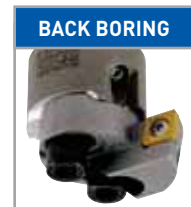



EWN, SERIES 112

Centric boring bars in modular and integral execution for accurate, high performance boring operations.

- Same accessories for precision boring heads EWN and EWD, series 112



INTEGRAL SHANKS AVAILABLE IN CV40, BT40, HSK-A63 & C6

Variable Tool Length Adjustment of the Tool Holder

Best cutting results are only reachable if the tool holder is as short as possible. The EWN features variable length adjustment of the tool holders which ensures the shortest and therefore the most rigid tool assembly.

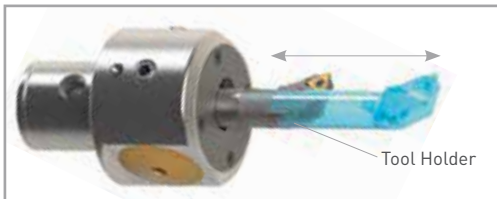

EWB, SERIES 112 — AUTO-BALANCE TYPE

Maximize cutting speeds and feeds due to an integrated counterweight, which allows for precision balancing of the tool assembly. Significant improvements to bore quality, surface finish and tool life.



SERIES 112

High Precision Finish Boring Heads

Designed for precision production boring on machining centers, jig mills, boring mills, transfer machines and high speed milling machines. Their fully enclosed, compact and rugged design allows reliable operation, even under extreme cutting conditions

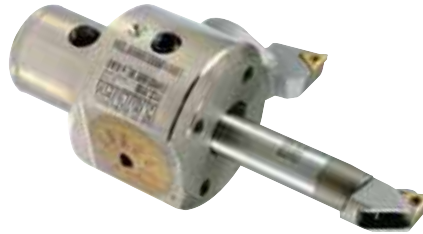

EWE, SERIES 112

Digital display and direct electronic measuring system on the tool carrier, feature absolute setting accuracy. The boring heads are designed for ultra precise boring operations.

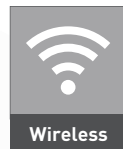

Body Protection Grade: IP 69K

Ensures a complete protection against corrosion. The built in electronic is safe from dust and high pressure spray water.



Digital Display With A Resolution of .00005"/ø

Automatic switch off function which always stores the last displayed value and integrated power management for optimized battery life.

Single Button For The Functions "On" And "Reset"

Electronic Components—Made by BIG KAISER

All electronic components are entirely developed and manufactured in the electronic lab of BIG KAISER in Switzerland. Before shipping, every digital boring head is calibrated and tested separately.

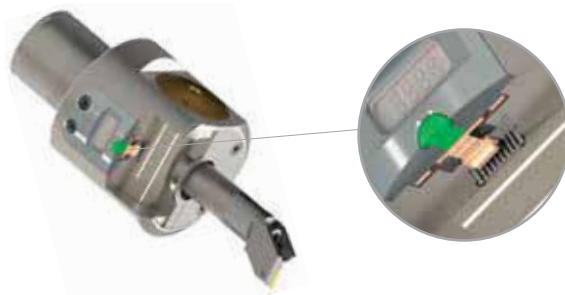



EWN, SERIES 310

The precision boring heads EWN series 310 cover a range of $\varnothing.590''$ - $8.000''$ with only 7 precision boring heads. Due to the optimized balance over the whole adjustment range, cutting speeds up to 4,000 SFM are possible.

- Precision boring heads EWN and EWD, series 310 feature equal boring ranges and body dimensions and allow the use of the same accessories.



EW x M6 & M10 Threaded Micro Head

Back Boring

Insert holder can be mounted in opposite direction for an easy changeover to back boring.

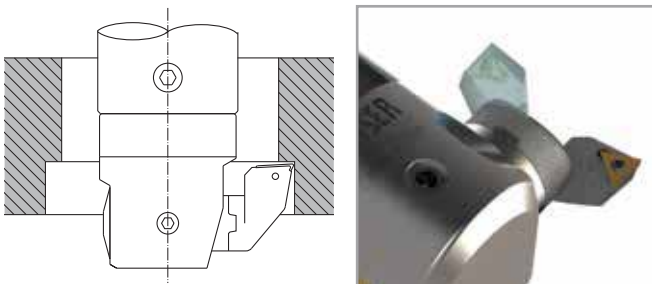

Versatile Tool

Insert holders for many types of inserts (TP/TC, CC, and different angles) as well as accessories for face grooving are available.



SERIES 310

High Precision Finish Boring Heads



EWE, SERIES 310

The boring heads EWD series 310 with digital technology combine all advantages of the analogue boring heads EWN. Thanks to the large display with a resolution of $.00005''/\varnothing$ bores with extremely tight tolerances can be machined.

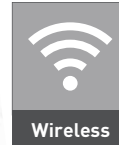

NEW!

Direct Measuring Diameter Allows Corrections In Both Directions

With a direct electronic measuring system on the tool carrier and a resolution of $.00005''/\varnothing$ enable diameter corrections with an unmatched accuracy.



EWB, SERIES 310 — AUTO-BALANCE TYPE

Maximize cutting speeds and feeds due to an integrated counterweight, which allows for precision balancing of the tool assembly. Significant improvements to bore quality, surface finish and tool life. Cutting speeds up to 6,600 SFM are possible.





SERIES 318

Large Diameter Boring System

High-speed, light-weight aluminum system for rough and finish boring, as well as O.D. turning and grooving applications. Pinned-to-fit mounting assures absolute safe operation in high speeds — up to 6,600 SFM! Features coolant supply through all components direct to the cutting edge.



UP TO
6,600
SFM

Larger Machines Up to $\varnothing 118"$!



AVAILABLE IN
DIGITAL



Large Diameter Face Grooving Up To $\varnothing 80"$!

Versatile System

Series 318 is for various applications such as roughing, finishing, pin turning, and face grooving.



Roughing

Finishing

Face Grooving

Pin Turning

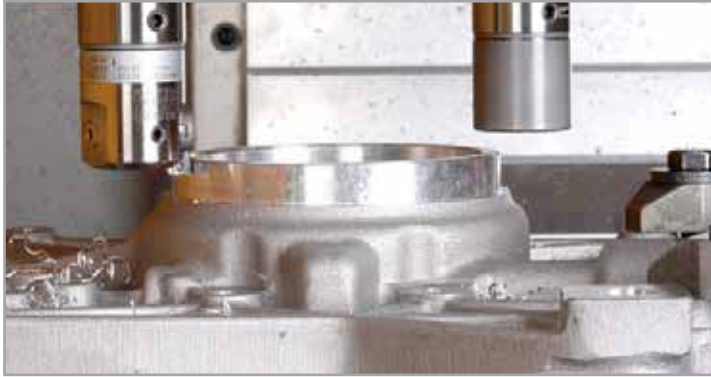

O.D. TURNING

Turning Systems

Radial adjustment of insert holder and counterweight allows for concentric location of turning attachment resulting in balance of the assembly.

SERIES 112 SMALL DIAMETER SYSTEM

Short, light weight turning adapter for use with EWN 2-50XL heads. Through-tool coolant to insert holder.

- Balanced tool assembly for entire work range of $\varnothing.039''$ - $1.260''$ ($\varnothing 1\text{mm}$ - 32mm)
- Through tool coolant to insert holder
- Fine adjustment of diameter with precision graduated head
- Short, lightweight assembly



SERIES 318 LIGHT WEIGHT LARGE DIAMETER SYSTEM

Turning adapter for use with EWN/TWN x CKB5 heads.

- Turning adapter with CK5 connection
- Can be mounted on any extension slide



SERIES 310/315 INTERMEDIATE DIAMETER SYSTEM

CKB5 & CKB6 modular adapters accepting CKB3-CKB5 EWN & TWN heads.

- Simple and cost effective execution
- Through tool coolant supply
- Modular construction, extendable, for long work pieces
- Suitable for boring operations



SERIES 318 X-LARGE DIAMETER SYSTEM

Bridge Tool Holder for X-Large Diameter Pin Turning.

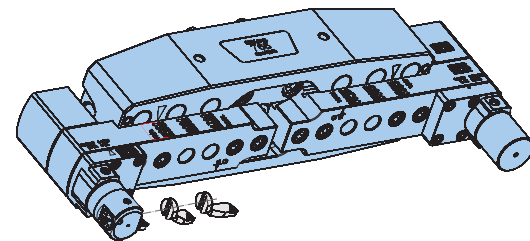



SMART DAMPER BORING

Unique Dynamic Damper Eliminates Chatter!

Achieves high speed and high efficiency machining for work requiring a long projection length.

EWN BORING HEAD
Integrated Type



SW BORING

PATENT #
9027720



Comparison of Oscillatory Waveforms

The Smart Damper incorporates a damping mechanism and reduces chatter instantly. The Smart Damper solves various problems caused by chatter due to long projection, such as poor surface roughness, unacceptable cutting time, and shortened tool life.

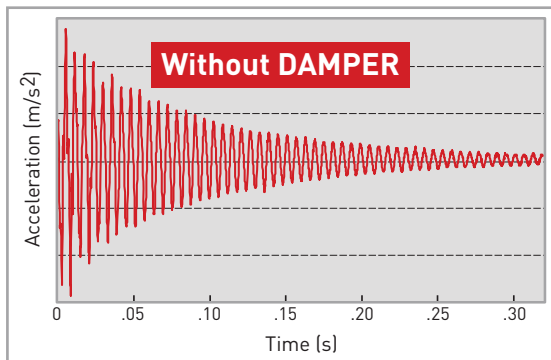
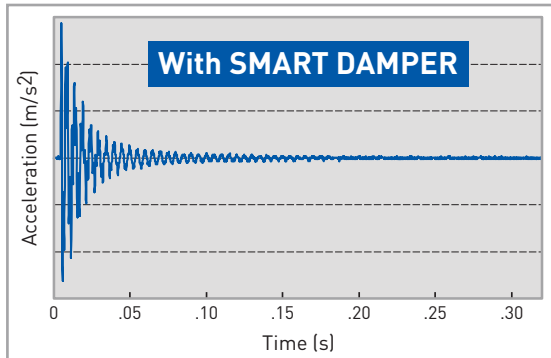

Chatter Suppressing Mechanism

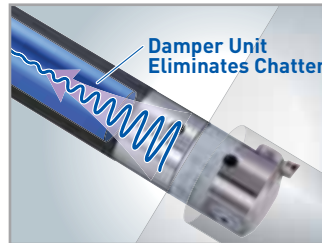

An incorporated unique damper that functions as both a counter damper and friction damper.

Patented counter weight maximizes effect of the friction damper. Chatter is absorbed effectively and higher machining accuracy is achieved.

An Abundant Series for a Variety of Requirements

CK BORING SYSTEM



STRAIGHT SHANK FOR NC LATHE



Finish Boring of Ductile Cast Iron (FCD500)

Tool Holder	Cutting Speed (SFM)				Result
	80	165	325	500	
Competitor (w/o damping system)	○	×	×	×	Outperforms competitor's holder by 6X higher productivity.
SMART DAMPER Built-in damping mechanism	○	○	○	◎	Superior surface finish and better tool life due to the increased cutting speed.

× = Vibration ○ = Acceptable ◎ = Excellent Surface Finish

Cutting Conditions

Machine: HMC (BBT50) BIG-PLUS
Boring Dia: ø2.677"
Depth of Hole: 16" (L/D=6:1)
Insert Nose Radius: R .016"
Feed Rate: .008"/rev.
Depth of Cut: .012"/ø

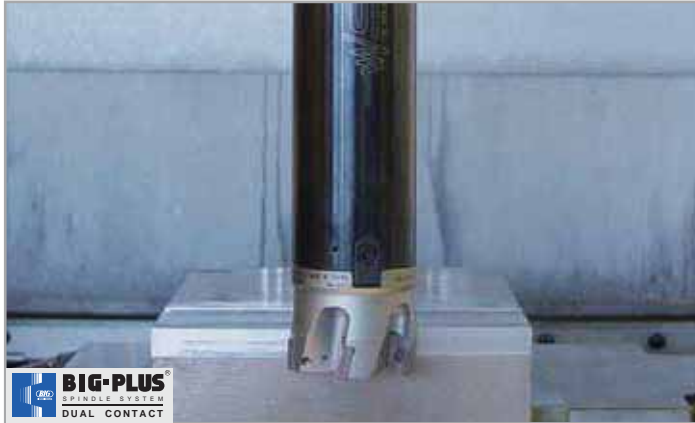

SMART DAMPER MILLING

Integrated Damping System

During extended reach face milling, a unique dynamic damping system eliminates vibration for higher productivity. Quiet, vibration-free milling with Smart Damper long projection tools provides better surface finishes and higher metal removal rates.

Combinations (Example of BBT50)

Select a suitable Basic Holder and Damper Head according to your application.

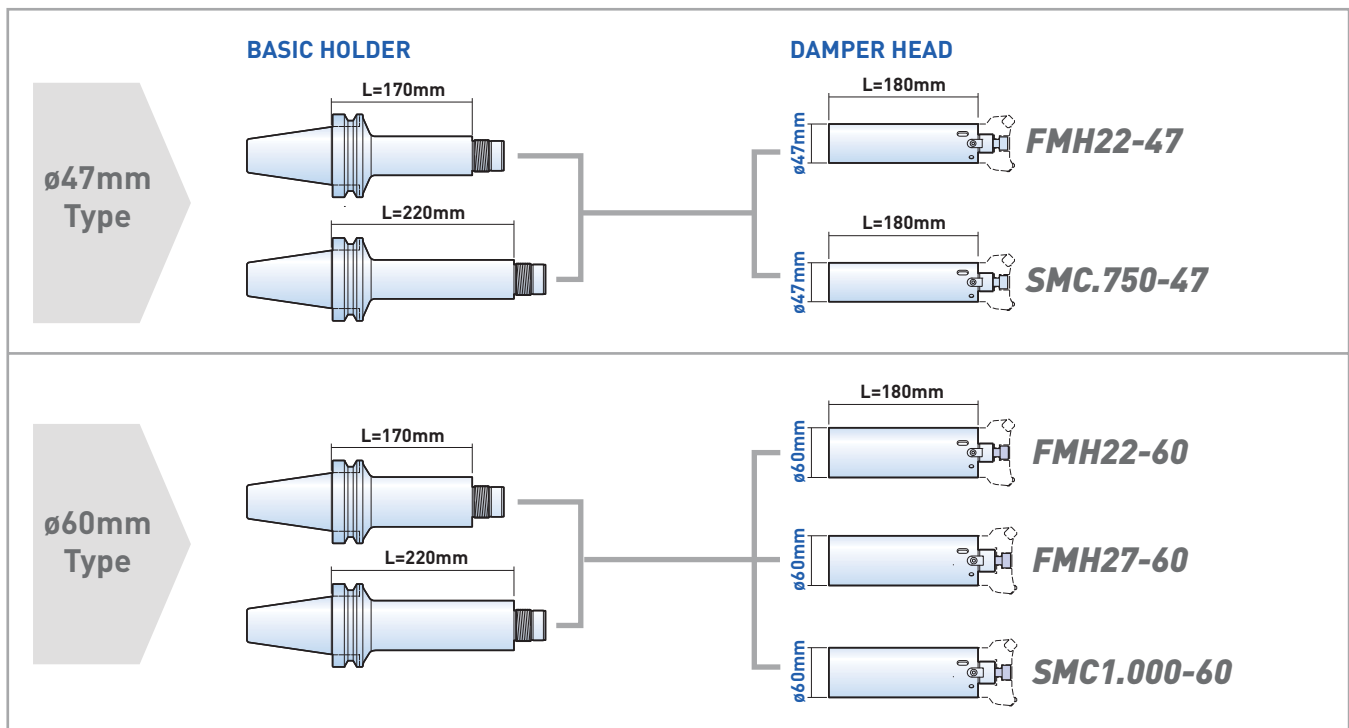

Face Milling of Ductile Nodular Cast Iron

Tool Holder	Radial Depth of Cut (inches)				Result
	.20	.40	.78	1.18	
Standard Holder (w/o damping system)	○	×	×	×	6X Deeper Depth of Cut
SMART DAMPER Built-in damping mechanism BBT50-SDF36-47-170 + SDF36-FMH22DP-47-180	○	○	○	○	

× = Vibration ○ = Acceptable ⊙ = Excellent Surface Finish

Cutting Conditions

Machine: VMC
BBT50 (BIG-PLUS)
Cutter: ø1.968 (4 inserts)
Speed: 300 SFM
Feed: .040"/tooth
Depth: .08"
Overhang: 13.67"

The Very First Modular Tooling System For Turning Applications on Mill-Turn Machines

A modular tooling system offers better efficiency, material selection, heat treatment and optimal tool lengths. The serious damage on tool holders caused by broken inserts can now be easily and economically replaced. Boring bar & square tool holders options also available.



45° TILT STYLE TYPE S

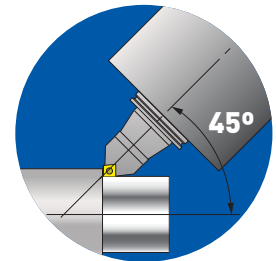

Minimized Cutting Forces

Tilting the "B" axis 45° helps to minimize the cutting forces transmitted to the machine spindle. This force reduction increases the life of the machine spindle & insert life.

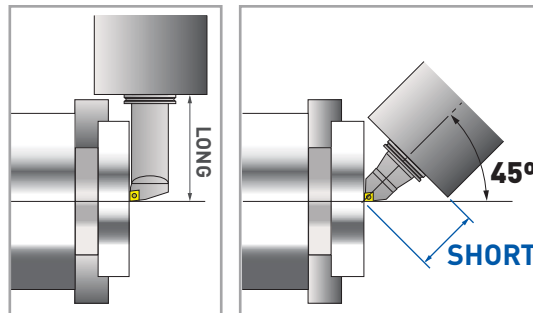
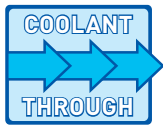

With the "B" axis at 45°, accessibility problems with the chuck or tailstock are overcome to minimize tool length.

Secure and Rigid Type S Cartridge Clamping System

Using highly sophisticated and modern machine tools, Type S Cartridges are made to very close tolerances required for turning accuracy and repeatability. The cartridge is located in the basic holder by means of a precision ground pilot and secured by 2 opposing radial screws with a 15° taper. With a slight offset to locating sockets, high face-to-face clamping force of the two components is generated. To maintain precise locations and orientation, an additional locating pin is included for positive transfer of cutting torque.

17 Cartridges for 45° Tilt Style Type S

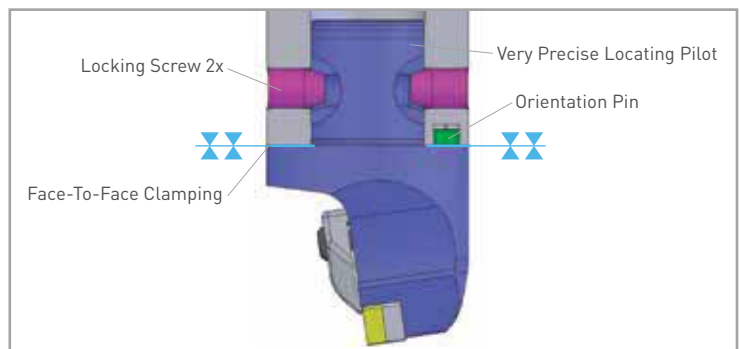

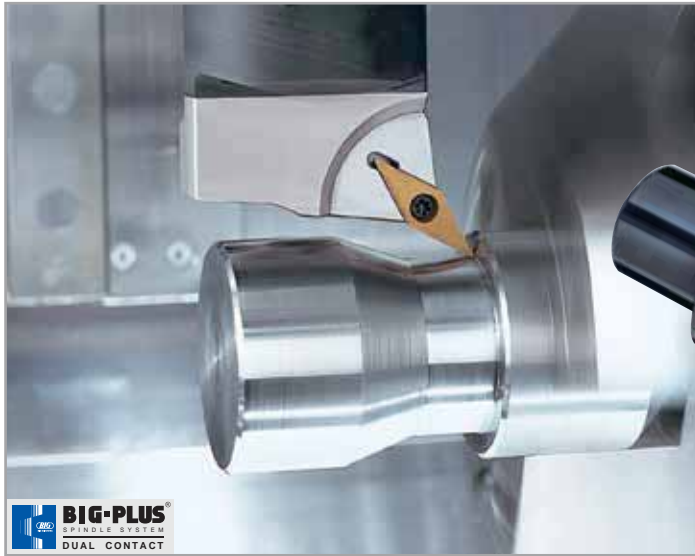

**90° RIGHT ANGLE
 STYLE TYPE F**

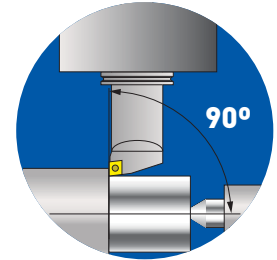

Right or Left Hand Versions Available

Two different basic holders are available and all can be assembled with either the right or left hand version of cartridges.

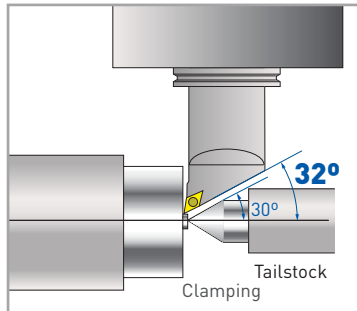
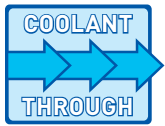

Center proximity type cartridge is also available, minimizing tailstock interference.

Simple and Positive Clamping

Type F uses two clamping bolts that press the cartridge onto the basic holder. The torque is transmitted by an interlocking drive slot.

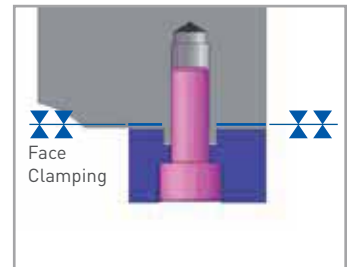
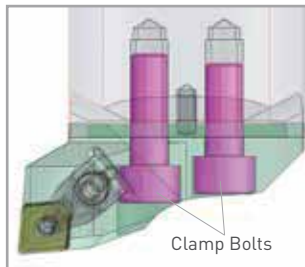

Safe and Easy Clamping of Inserts

The double-clamping system simultaneously pushes an insert downward and draws it into the contact faces to achieve secure and rigid clamping.

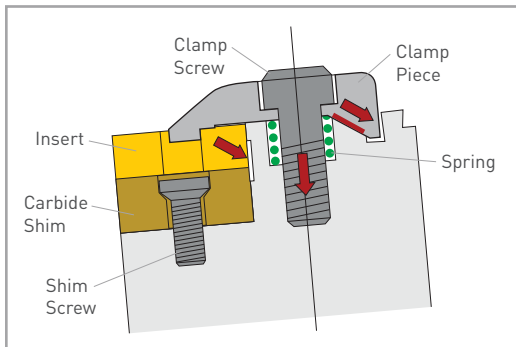

36 Cartridges for 90° Right Angle Style Type F





ANGLE HEAD

Eliminate multiple set-ups and combine vertical, horizontal and angular operations on one machine. One original set-up saves time, speeds production and guarantees better accuracy.



A Variety of Compact and Rigid Heads Suitable for all Kinds of Machining Applications

AG90 SERIES

 <p>NBS TYPE High precision collet chuck system</p>	 <p>COMPACT TYPE For drilling-tapping</p>
 <p>BUILD-UP TYPE Interchangeable adapter system</p>	 <p>HMC TYPE ø1.25" high power design</p>

AGU SERIES

 <p>UNIVERSAL TYPE Angle adjustment by 1° increments</p>	 <p>AGU30 TYPE 30° limited version</p>
---	--

Ultra Small Head

 <p>SLENDER DRIVE Min. ø1.18" bore</p>



Special Versions Available

We are able to design and manufacture special ANGLE HEADS such as custom angles or long type models to answer every machining condition.



A Wide Range of Compact and Rigid Heads, From Milling Chuck Types to Universal Types, Suitable for All Kinds of Machining Applications

Build-Up & HMC Type

Overhang is minimized for added rigidity and strength. As a result, the projection length with the cutting tool is shorter, which reduces the overall load on the ANGLE HEAD and thus improves the unit's cutting capabilities. Further, the minimized overhang helps eliminate interference with the ATC (automatic tool changer) and connecting storage pockets in the tool magazine. High Rigidity S-Type, which has a steel housing and a stronger locating pin assembly, is also available.

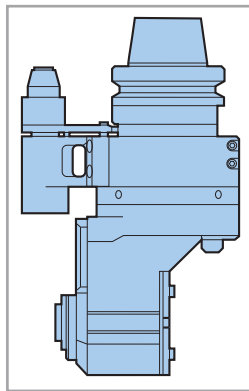

**ATC may not be utilized for some machining centers.*



Extra Long NBS Style ANGLE HEADS

Available with 4" (100mm), 8" (200mm) and 12" (300mm) extensions. Any 50 taper or HSK-A100 size NBS head can be extended for drilling or milling on workpieces with long reach requirements.

Superior Quality Components

For smooth and powerful operation and to minimize noise and vibration, all ANGLE HEADS are equipped with hardened and ground chrome-nickel steel spiral bevel gears, super precision hardened and ground spindles, and high precision angular contact ball bearings.



Cutter Head Adjustable 360°

Reference faces are provided on both sides of all heads for easier setting of cutter directions.

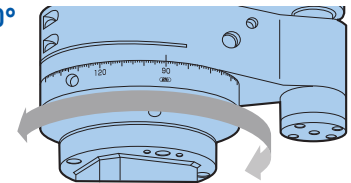

Innovative Sealing Method

The advanced no contact sealing method prevents coolant and particle contamination better than any other sealing method.



MAX COOLANT PRESSURE
150
PSI

Unique Coolant Jacket

Jacket allows coolant coming through the stop block to be efficiently directed to the cutting tool edge while simultaneously cooling the ANGLE HEAD.



HIGH SPINDLE

HIGH SPINDLE improves drilling and end milling performance on existing machining centers by multiplying the spindle speed 4, 5 or 6 times.

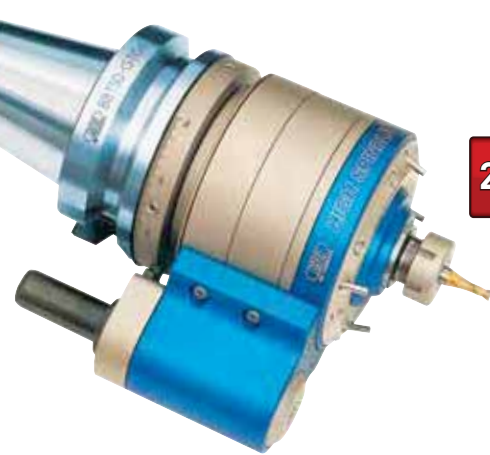

**MAX
20,000
RPM**

Reinforced Gear Driving System

The planetary gears, which have been constantly upgraded since the development of our first "HIGH SPINDLE" back in 1970, achieves smooth operation with minimal heat generation and high torque transmission.

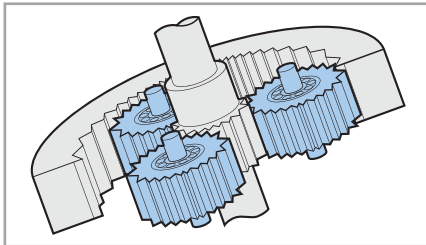

Rigidity Increased 1.7 Times

Larger diameter body and spindle with double angular contact bearings and reinforced locating pin assembly greatly increase rigidity.

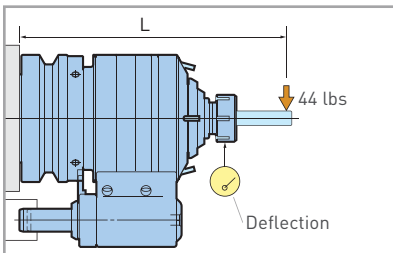

Catalog Number	L	Deflection	Comparison
BBT40-GTG5-10-140-65	7.87	.0014	58% less
BBT50-GTG6-10-158-80	8.66	.0010	78% less
BBT50-GTG4-16-177-80	9.45	.0004	93% less

Reduce Load To Machine Spindle

Continuous use at HIGH SPINDLE speeds will reduce the life of a machine spindle due to the excessive load to the motor and bearings. The HIGH SPINDLE reduces this load and greatly extends the life of a costly machine spindle.

Multi-Directional Coolant Supply

Universal coolant nozzles are capable of being adjusted to suit the length of the cutting tool. Thus, the maximum coolant delivery to the cutting edge is assured.

- HIGH SPINDLE can be operated without coolant running through the housing



Pinpoint Coolant Jet for Shorter Cutting Tools

A 1/8 pipe tap thread is provided in the HIGH SPINDLE so that various types of customer supplied coolant-jet nozzles can be utilized which will provide pinpoint delivery to the cutting edge of short tools (BCV/BBT taper models only).

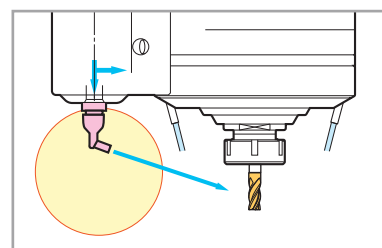



AIR POWER SPINDLE

High-speed micro-machining can be done on a normal machining center, eliminating the need of an expensive high-speed machine.

**MAX
120,000
RPM**

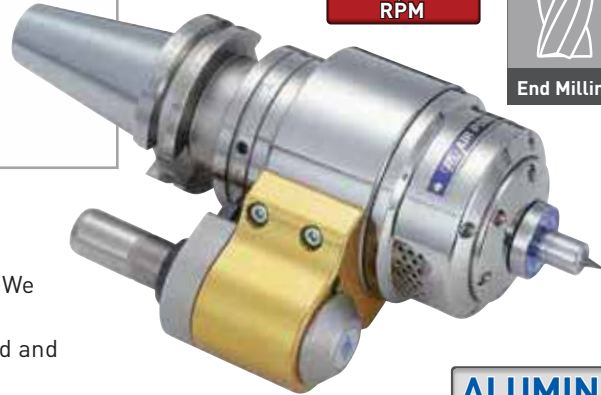
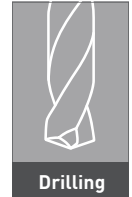

Dynamic Runout Accuracy

Most problems associated with micro-machining are caused by poor dynamic runout of a machine spindle. We have established a runout measuring system that can detect spindle movement during rotation at high speed and achieved the best dynamic runout accuracy.

RBX (80,000 RPM)

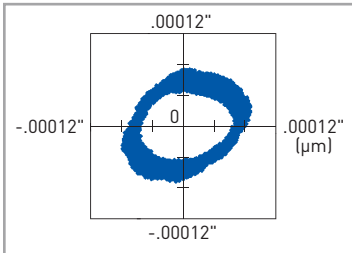

Plotted Position of a Test Bar at the Max Spindle Speed

- Improved machining accuracy
- Extended tool life
- Superior surface finish

ALUMINUM A2017 OUTSTANDING RUNOUT ACCURACY PERMITS SUPER THIN WALL CUTTING

Application Example

RBX7	Cutter	ø.02" (ø.5mm) Rib-End Mill
	Spindle speed	70,000 RPM
	Feed	59 IPM (1,500 mm/min)
	D.O.C	Ad= .0008" (.02mm)

Recommended Clamping Range

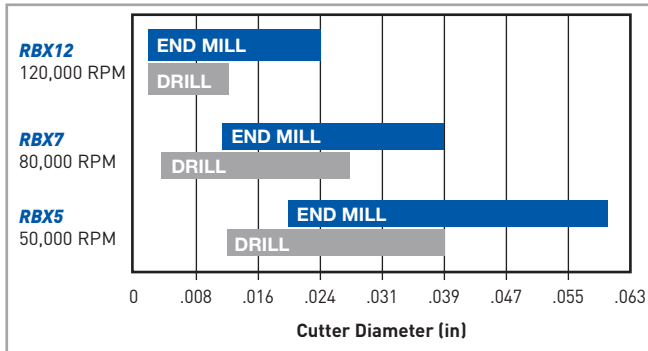

• The table is just for reference. Machining range may change according to material, cutting conditions and cutting tools

Minimized Spindle Expansion

Air turbine drive prevents thermal expansion of the spindle, which is essential for high accuracy micro-machining.

Axial Displacement Compared to Operating Time

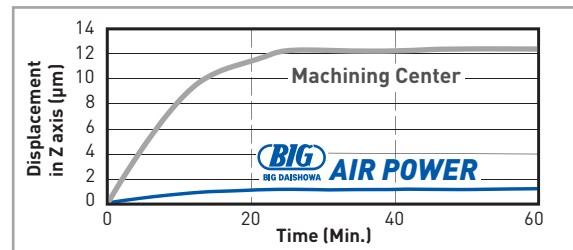

Automatic Tool Change

ATC type is available by supplying air via a stop block to enhance productivity with unmanned operation.

Air Pressure: 90 PSI
Air Consumption: 7 CFM

HIGH PRECISION

MEGA MICRO COLLET NBC4S COLLET

Max Cutter Shank: .157"



Guaranteed Max Runout

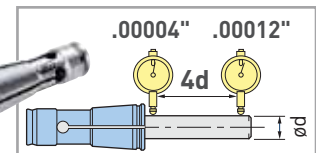



Hi-JET HOLDER

Coolant feed for water-soluble coolant only. Bearings are in a separate housing from the coolant for extended life.



Non-Contact Seal Design Eliminates Wear Damage to Body

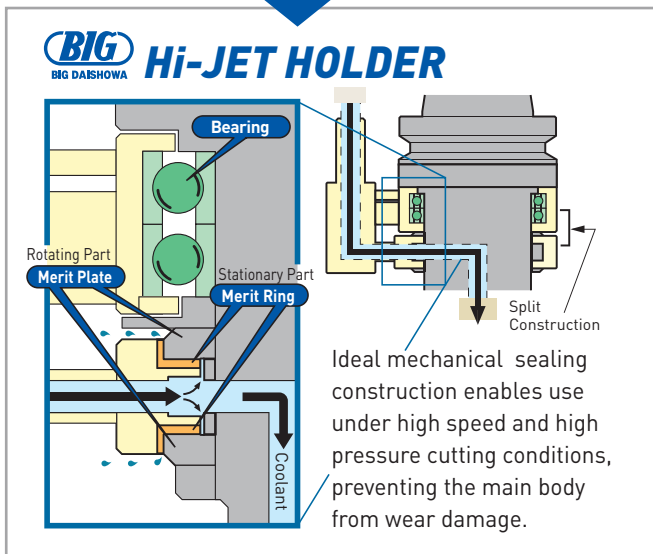
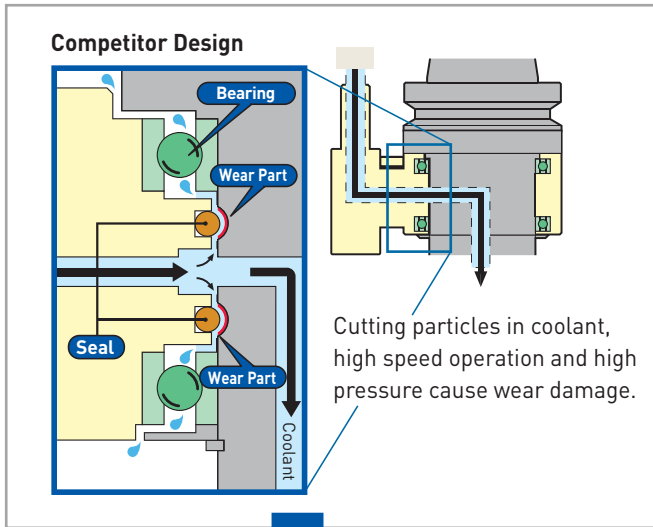

Suitable For Small Dia. Cutters Due to High Speed and Pressure

Small diameter cutters require HIGH SPINDLE speeds to maintain high cutting speed and high coolant pressure due to their small dia. coolant holes. The Hi-JET HOLDER accepts even smaller diameter shanks, providing HIGH SPINDLE speeds (Max 10,000 RPM) and high coolant pressures (Max 284 PSI).

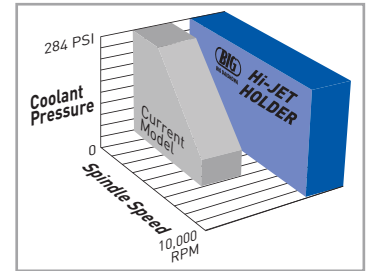

Easy Maintenance by Replacement of Wear Parts

Easily replaceable Merit Sets consist of Merit Plates, Merit Rings and O-Rings.

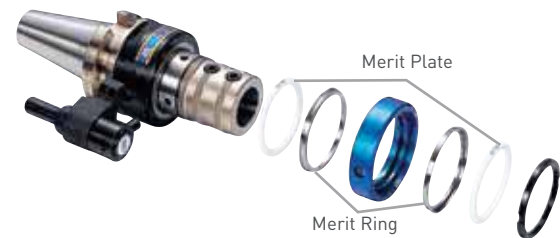

A Variety of Hi-JET HOLDERS Available

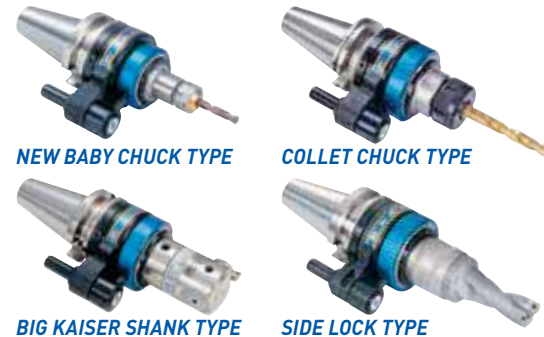



DYNA TEST



STATIC

Static precision test bar with a focus on superb quality and accuracy. Prevents trouble through the periodic inspection of machine runout accuracy.

- A high-precision test bar developed by BIG's precise machining technology.
- Periodic accuracy evaluation eliminates machining defects.
- Abundant variation to suit the standards of each holder.

PRECISION STANDARDS OF BIG DAISHOWA TEST ARBORS	
Runout	.002mm (.00008)
Roundness	.001mm (.00004)
Cylindricity	.003mm (.00012)
Roughness	Ra: .1µm (.000004)
Taper Contact	AT1
Diameter Tol.	±.005mm (.0002)



Aluminum Case

An aluminum case is provided to protect and store the test bars.

- BIG Daishowa provides high quality test bars produced under a strict quality control system



DYNAMIC

Measures dynamic runout of machine spindle during rotation. Knowing the dynamic accuracy of the machine tool spindle affected by centrifugal forces, vibrations and heat will aid in finding the appropriate cutting parameters for actual machining.

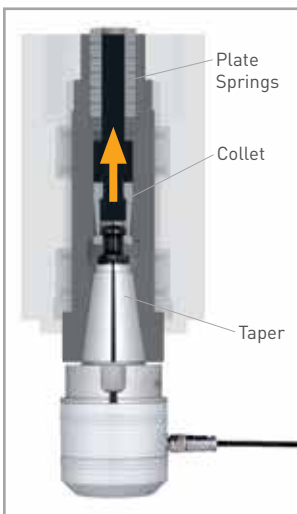

DYNA FORCE

Tool clamp measuring device for measuring pulling force of machine tool spindle, a vital factor of machine tool performance. The pulling force produced by the clamping device of machine tools could deteriorate due to degradation of disc springs or wear of the components of the amplifier.

Pulling force is especially vital when it comes to dual face contact spindle interface, thus regular inspection is recommended.

Only One Display for All Taper Sizes

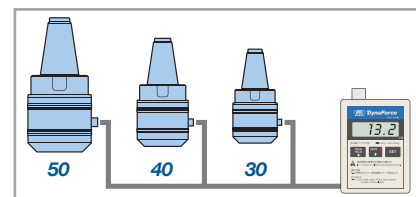

The spindle is the most essential part of a machine tool. Maintaining the accuracy of the spindle is almost equal to extending the life of the machine tool itself. Even periodical inspection of the runout accuracy makes a large difference.



Quick Detection of Reference Position

Measuring is the decisive factor for the following process. Sensor series minimizes machine down time.

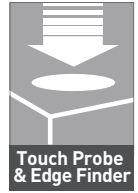

3-Dimensional Touch Sensor Series

POINT MASTER PRO
3-D Touch Probe

For all cutting tools, workpieces and machine tools



POINT MASTER

For use with conductive cutting tools, workpieces, and machine tools.

Detection with LED and beep



3D MASTER RED

Dial indicator 3-D measuring instrument.

NEW!

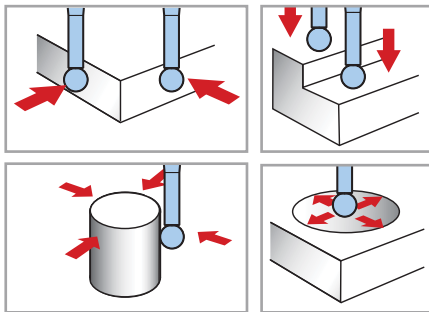

ACCU CENTER

High precision edge finder suitable for all materials. Repeatability within 3µm.

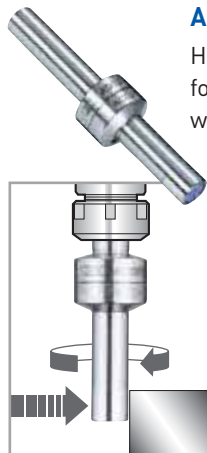

Make sure to check the coating material on the cutting tool before using conductive compact sensors. TiN coatings are conductive, but some multi-layer coatings do not conduct electricity. High speed machine tool spindles often use non-conductive ceramic bearings. Select sensors available for any material for use under nonconductive environments.



Quick Detection of Workpiece Offset and Tip Position

Abundant series available for various tool materials and diameters.



Repeatability Within 1µm—LED Illuminates When The Cutting Edge Touches The Sensor Plate

BASE MASTER

Measures 2" or 50mm from cutting edge and workpiece top surface
For use with conductive cutting tools, workpieces and machine tools.



BASE MASTER GOLD

Electronic detection of cutting edge position
For all cutting tools, workpieces and machine tools



BM-100G

Cutting edge position detection of 100mm from workpiece top surface

BASE MASTER MICRO

Cutting edge position detection for $\varnothing.002''$ tool diameters
For all cutting tools, workpieces and machine tools



BASE MASTER RED

Measuring unit can be easily replaced
For all cutting tools, workpieces and machine tools

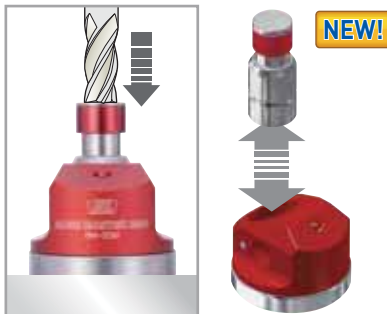

BASE MASTER MINI

World's smallest tool offset sensor with diameter of $\varnothing.787''$ ($\varnothing 20\text{mm}$).
Easy maintenance by replacing measurement part!!



With Loupe (5x Magnification)

TOOL MASTER

Detects tool position for all materials including non-conductive tools and workpieces.
For all cutting tools, workpieces and machine tools

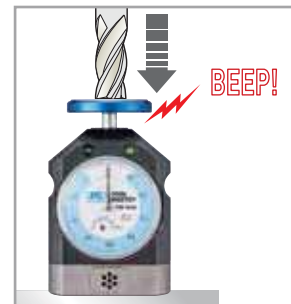



FULLCUT MILL

Sharp Cutting Edge by Both High Radial and Axial Rake Angles

Positive high rake cutting edge for both radial and axial directions achieves smooth and quiet end milling.

LOW CUTTING RESISTANCE

TYPE FCR

Ramping & Helical Milling Cutter

Unique inserts designed for ramping make multi-functional cutting possible. For ramping, helical milling, peck-milling, grooving & shoulder milling.



TYPE FCM

Square Shoulder & Slot Milling Cutter

Low resistance, high efficiency cutter especially for cross-feed machining. For grooving & shoulder milling.

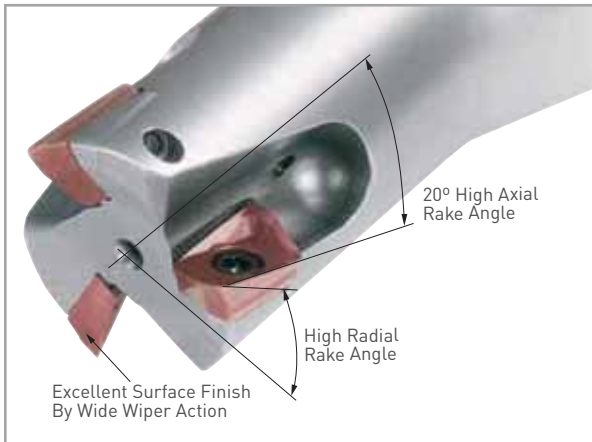

Amazing Cutting Performance Even on a #40 Taper Machine

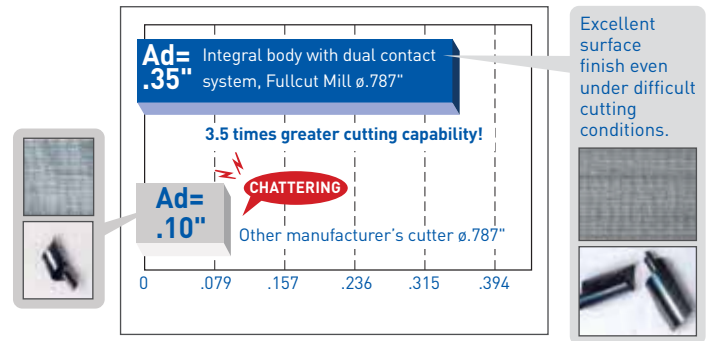

Positive Rake Angle Offers High Toughness—Strong Cutting Edge Reduces Edge Chipping

FULLCUT MILL	CONVENTIONAL

First Indexable End Mill with Eccentric Relief Angle

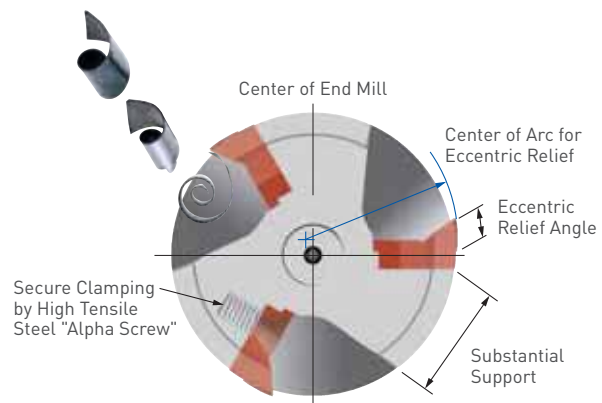

Application Examples—all of the following application examples are achieved with dry cutting

Bore $\phi 1.500$ with Helical Milling

In 1050 carbon steel, very smooth cutting with a feed rate of 43 IPM and excellent squareness is achieved.



Fullcut Mill Model BBT40-FCR20083-120	
Insert	BRG200808 (ACP300)
Work Material	1050 Carbon Steel / Air blow
Cutting Speed	492 SFM
Feed Rate	43 IPM
Axial DOC	.079 x 3 times
Hole Dia.	$\phi 1.500$

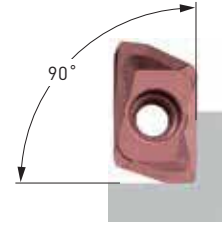

Honeycombed Pocket with Ramping

Low rigidity workpiece, .12 thickness clamped by a vise. Feed rate of 169 IPM on both sides of the workpiece is achieved.



Fullcut Mill Model BBT40-FCR20083-85	
Insert	BRG200808 (DS20)
Work Material	Aluminum / Air blow
Cutting Speed	2,461 SFM
Feed Rate	169 IPM
Axial DOC	.236 x 3 times
Radial DOC	Max .787



Helical Milling

Stable helical milling, .157 axial DOC on less rigid workpiece.

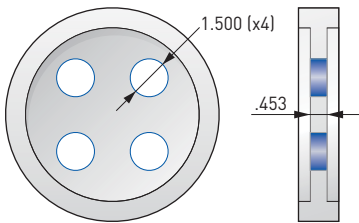

Fullcut Mill Model BBT40-FCR20083-120	
Insert	BRG200808 (ACP300)
Work Material	5015 Steel
Cutting Speed	150 SFM
Feed Rate	480 IPM
Axial DOC	.157 x 3 times
Hole Dia.	$\phi 1.500$

Compared to Another Manufacturer

Axial DOC **➔ 1.4 Times**
Insert life **➔ 2 Times**

Ramping

Example uses BBT50-BBT40 adapter. An improved result is obtained compared to another manufacturer.

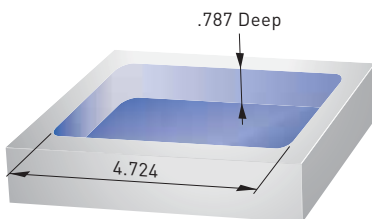

Fullcut Mill Model BBT50-BBT40-50 & BBT40-FCR16082-120	
Insert	BRG160808 (ACP300)
Work Material	1050 Carbon Steel
Cutting Speed	120 SFM
Feed Rate	480 IPM
Axial DOC	.157 x 5 times

Compared to Another Manufacturer

No chatter even at higher resistance corner.
Smooth chip evacuation eliminates re-cutting of the swarf and edge chipping of the inserts.



SPEED Finisher

CUTTER DIAMETER: $\varnothing 50, \varnothing 63, \varnothing 80, \varnothing 100, \varnothing 125, \varnothing 160$

High Speed Cutter for Aluminum and Cast Iron

Greatly improves the surface finish in ultra-high-speed machining!

Achieves $Rz = .55\mu m$ for die-cast aluminum ADC12 and $Rz = .67\mu m$ for gray cast iron FC250.

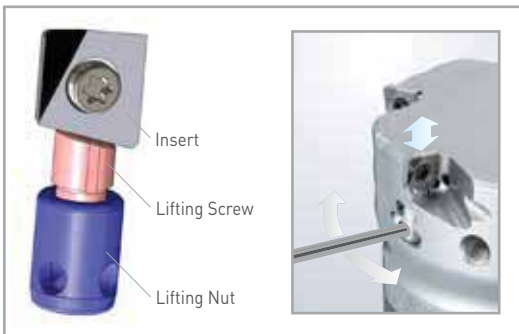

Speedily Adjusts the Cutting Edge Height

It has a simple and highly operable mechanism in which the cutting edge height is adjusted after clamping the insert by turning the lifting nut from the side, then directly pushing up the insert with the lifting screw. Since the lifting screw has a fine pitch (.25mm), accurate adjustment is possible.

Combines Light Weight and High Rigidity

The slim body allows increased rigidity and reduced vibration and deflection. Therefore, height difference of the machined surface is minimized.

Also, as it is lighter than other cutters, it can be safely used with a small #30 taper machining center.

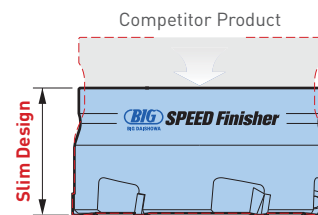

Direct Coolant Supply to The Cutting Edge

Use in combination with the Face Mill Arbor Type FMH allows coolant to be supplied directly to the cutting edge.

This prevents welding and re-cutting of chips in aluminum workpieces.

Not only has the finishing surface roughness been improved, but by correctly aligning the cutting edge height, feed per tooth can also be increased for the same surface roughness, allowing high-efficiency machining. As the insert uniformly touches the workpiece, the life can also be extended.



FULLCUT MILL

CUTTER DIAMETER: ø50, ø63, ø80, ø100

Arbor Type Indexable Insert End Mill
Sharp and powerful cutting

Exhibits incredible cutting capacity even with #40 machining centers or mill-turn machines.

Compatible with new-standard Face Mill Arbor type FMH.

Perpendicularity and Beautiful Surface Finish Unmatched in Indexable Insert Cutters

Machined with holder BBT40-FMH22-47-45 and Fullcut Mill FMH22-FCM63116-40



Perpendicularity	
Cutting Speed Vc (m/min)	150
Feed Rate fz (mm/blade)	.1
Axial DOC ap (mm)	5
Radial DOC ae (mm)	.1

BIG BIG DASHOWA	10µm
General Cutter	40µm

Wiper Flat	
Cutting speed Vc (m/min)	250
Feed rate fz (mm/t)	.2
Axial DOC ap (mm)	.1
Radial DOC ae (mm)	50

	Ra	Rz
BIG BIG DASHOWA	.51	2.89
General Cutter	1.56	7.77

• The perpendicularity & surface roughness will vary depending on the cutting conditions, material, machine tool & workpiece rigidity.

In 90° corner milling, the insert with a positive shape and large rake angle reliably curls the cutting chips, increasing the evacuation performance. The high rake insert used in the Fullcut Mill will be helpful.

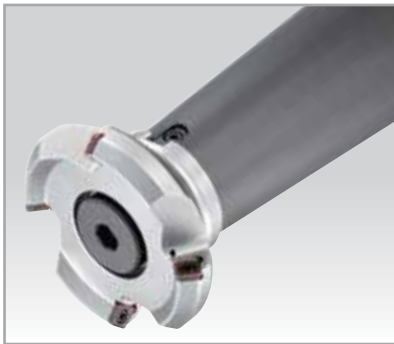

SURFACE MILL



CUTTER DIAMETER: ø80

Face Mill Cutter

Exhibits difference in the top surface finish of the workpiece!

Surface Finish Comparison with a General Cutter

Workpiece Material	1050
Cutting Speed Vc (SFM)	660
Feed Rate fz (in/insert)	.008"
Axial DOC ap	.118"
Radial DOC ae	3"
Cutting Method	Dry

 SURFACE MILL (FM25.4-SFM804-40)		General Cutter	
Rz=1.42		Rz=9.04	

Glossiness of the machined surface with a face cutter is affected by the sharpness of the insert. By using different cutters between roughing and finishing operations, not only can a beautiful surface finish be achieved, but the life of the insert can also be easily managed to obtain stable quality.

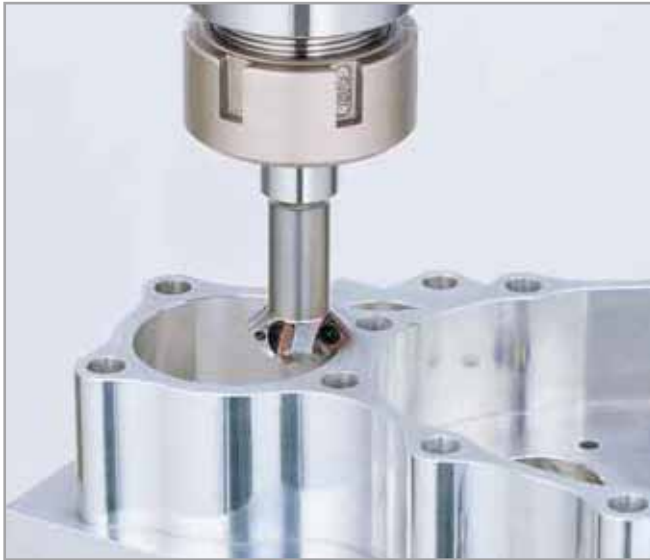

C-CUTTER mini

Ultra High Feed Chamfer Mill

Compact design with 4 inserts & small cutting diameter. High performance chamfer cutter achieves ultra high feed rate by reducing the cutting diameter to the lowest limit.

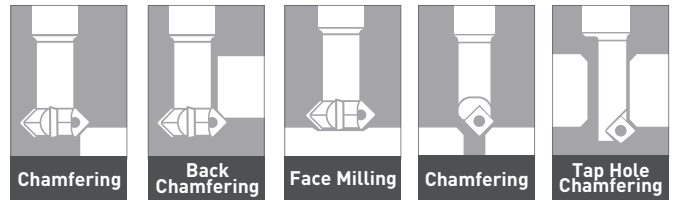

A Variety of Interfaces Available



Four Inserts, Small Diameter and New Coating Achieve a TRIPLE EFFECT

EFFECT 1 — Maverick Design with Ultra High Feed by 4 Inserts

Compared with 1 or 2 inserts per cutter, a 4 insert cutter multiplies the feed rate.

EFFECT 2 — Increased Spindle Speed by Ultra Compact Diameter

A smaller tool diameter means faster spindle speeds.

EFFECT 3 — Latest Coatings [ACP200/300] Increases the Cutting Speed

Wear resistant multi-layer PVD coating increases the cutting speed.

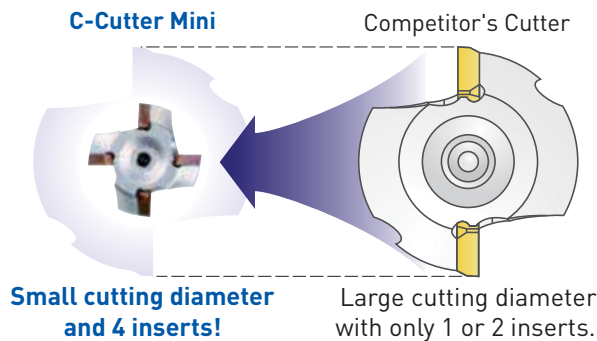

Considerably Improved! **UP** **UP**

$$\text{Feed Rate} = \text{Spindle Speed} \times \text{Feed Per Tooth} \times \text{No. of Teeth}$$

UP **UP**

$$\text{Spindle Speed} = \frac{\text{Cutting Speed}}{\pi \times \text{Cutting Diameter}}$$

UP **Small dia.**

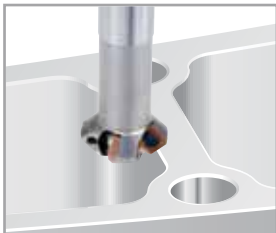

8 TIMES GREATER CUTTING EFFICIENCY

Cutting Conditions
 Workpiece: S55C
 Chamfering Amount: C1
 Feed Per Tooth fz: .1mm/t

	General Products	C-CUTTER MINI (ST12-C116-45B-25)
Chamfering diameter	ø29	ø13.5 Small Diameter
Number of inserts	2	4 UP
Cutting speed Vc (m/min)	150	300 UP
Spindle speed n (min-1)	1,644	7,040 UP
Feed Vf (mm/min)	329	2,820 Much Higher!



Hex Insert

Highly-efficient back chamfering from 5mm starting hole diameter. 3-corner insert saves cost.



C-CUTTER

Chamfering Tool

HOLE DIAMETER: ϕ .200"-4.000"

Wide chamfering range reduces number of tools and ATC.



Chamfering Angle Can Be Easily Adjusted By 5° To 85° (Universal Type)

The cartridge swings when the angle adjuster is turned.



C-CENTERING CUTTER

A multifunction cutter capable of both spot drilling and chamfering. Negative insert tip shape dramatically improves the life



Capable of Both Spot Drilling and Chamfering

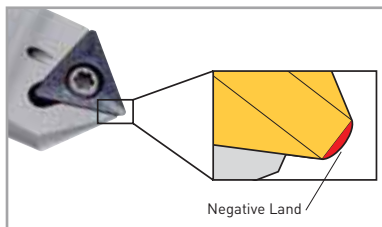
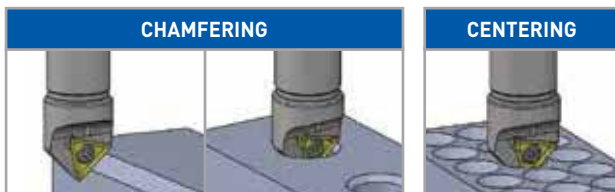

Prevents Chipping During Spot Drilling

As the nose radius on the insert forms negative land, it has high chipping resistance, and the tool life is significantly extended.



Immediate Evacuation of Chips with Coolant Supply

By providing coolant holes, it is possible to cool the cutting edge and immediately discharge the chips.



R-CUTTER

Ultra High Feed Radius Chamfer Mill

Automates rounded chamfering for both the front and back.

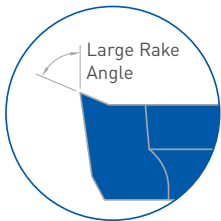

Excellent Sharpness High Rake Angle with 4 Indexes

Unique insert geometry with excellent sharpness. High rake angle reduces cutting resistance and minimizes the generation of burrs.



Four Corners Can Be Used For Better Economic Efficiency

A throw-away insert that allows all four corners to be used, making cost reduction possible.

It is well known that changing the chamfer of the workpiece from the C-plane to the R-plane will considerably change the texture of the workpiece. This can be considered an added value.



CENTER BOY

Centering and Chamfering Tool

Accurate positioning in drilling and chamfering can be performed simultaneously.



Highly Accurate Replaceable Insert

- Sharp cutting with optimum cutting edge
- No more regrinding
- Minimum interference with a slim, extended shank
- 90° and 120°

Ease of Operation Shortens Cycle Time

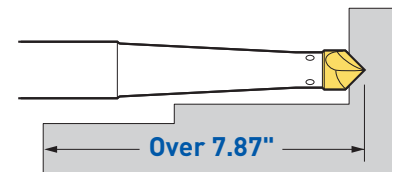
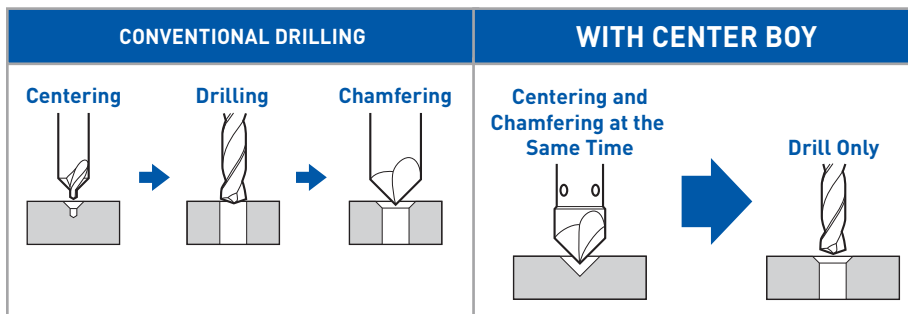

Long Type Avoids Interference

The long type covers workpieces with maximum depth of 200mm or more.

Centering before drilling can be considered the most important process in determining the center of the compass. Correct centering has a great effect in extending tool life.



C-CUTTER BOY

Chamfering Tool
HOLE DIAMETER: \varnothing .20"-1.00"

The carbide guide prevents chatter on bench drilling machines.
 Economical three-corner insert.

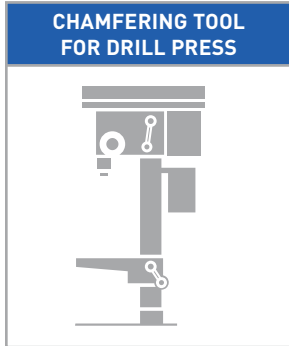

Carbide Guide

Carbide Guide Allows Stable Cutting

Carbide guide allows stable cutting and prevents triangular chamfering. It does not damage the body, extending the life.

Insert That Does Not Need to be Reground

Inserts do not require regrinding. Moreover, the carbide coating insert with 3 usable corners offers lower cost and extended tool life.

Although the C-Cutter Boy has been developed for chamfering using a drill press, it is also capable of stable chamfering without chattering even in low-rigidity conditions such as horizontal machining with long projection, thanks to the carbide guide.



BF-CUTTER

Back Spot Facer
CAP BOLT SIZE: M6 - M30

- Economical insert type
- Optimal design that matches the cap bolt size

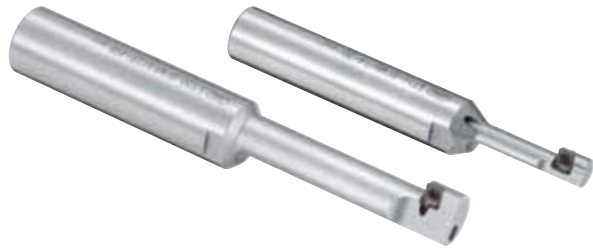

Reliable Cooling Through Oil Hole

Coolant can be supplied to cutting edges (all models).

It securely supplies coolant even in places that are hard to reach such as when machining a rear surface, contributing to the extension of tool life.

Easy NC Programming

Simple programming: Offset the machine spindle and starting hole centers before inserting the BF-Cutter into the hole.

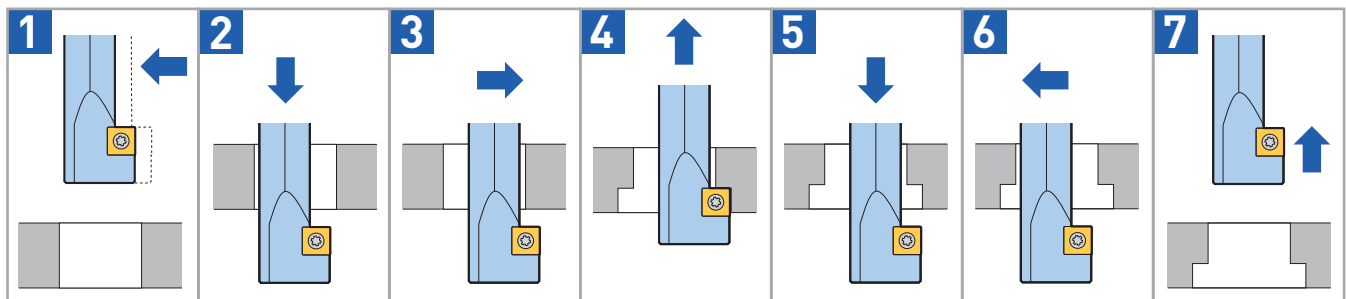

There is no official standard spot facing diameter for the cap bolt. Unifying the cap bolt spot facing diameter is one of the ways to reduce costs. In doing so, consider the spot facing diameter of the BF-Cutter.

DUAL CONTACT BIG-PLUS

BCV/CV SHANK



COLLET CHUCKS	58-62
MEGA MICRO CHUCK	58
MEGA NEW BABY CHUCK	59-60
MEGA ER GRIP	61
MEGA E CHUCK	62
MILLING CHUCKS	63-67
MEGA DOUBLE POWER CHUCK	63-64
MEGA PERFECT GRIP	65
NEW Hi-POWER MILLING CHUCK	66-67
HYDRAULIC CHUCKS	68-70
BASIC ARBORS	71-77
SHRINK FIT HOLDER	71
SHELL/FACE MILL HOLDER	72-75
END MILL HOLDER	76
SMART DAMPER MILLING	77
TAP HOLDERS	78-79
MEGA SYNCHRO TAPPING HOLDER	78-79
MODULAR HOLDERS	80-85
CKB SHANK	80-83
BIG CAPTO SHANK	84
ABS SHANK	85
ANGLE HEADS	86-95
AG90	86-93
AGU	94-95
SPEED INCREASERS	96-99
AIR POWER SPINDLE	96-97
HIGH SPINDLE	98-99
COOLANT INDUCERS	100-101
Hi-JET HOLDER	100-101
ACCESSORIES	102-104
PULLSTUD BOLTS	102
DYNA TEST	103
ATC ALIGNMENT TOOL	103
BIG-PLUS CLEANER	103
BLANK BAR	104

BCV/CV
A.1

MEGA MICRO CHUCK—TYPE T

CLAMPING RANGE: ϕ .018"-.317" For Micro Drill & End Mill Applications

MAX
35,000
RPM

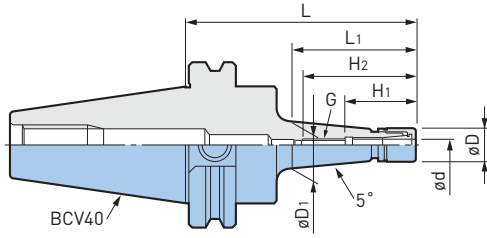
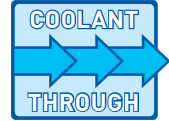

Catalog Number	ϕd	ϕD	D1	L	L1	H1	H2	G	Collet	Nut	Wrench	Max RPM	Weight (lbs.)
BCV40-MEGA3S-2.5T	.018-.128	.394	.47	2.50	1.01	.87	1.50	M4 P0.7	NBC3S-□	MGN3S	MGR10	35,000	2.2
-4T			.76	4.00	2.38							25,000	2.4
-MEGA4S-2.5T	.018-.159	.472	.54	2.50	1.01	1.04	1.85	M5 P0.8	NBC4S-□	MGN4S	MGR12	35,000	2.2
-4T			.78	4.00	2.38							25,000	2.4
-MEGA6S-2.5T	.018-.238	.551	.60	2.50	1.01	1.12	1.93	M7 P0.75	NBC6S-□	MGN6S	MGR14	35,000	2.2
-4T			.84	4.00	2.38							25,000	2.4
-MEGA8S-3.5T	.116-.317	.709	.91	3.50	1.93	1.22	1.99	M9 P0.75	NBC8S-□	MGN8S	MGR18	30,000	2.4
-6T			1.35	6.00	4.50							15,000	3.1

- MEGA MICRO NUT is included, collet and wrench must be ordered separately
- Weight includes nut but not collet
- Please note that the practical spindle speed may be considerably influenced by the machine rigidity and tool balance, when using, slowly ramp up to the appropriate speed starting from slow speeds

ACCESSORIES

 COLLET PG. 334	 MEGA NUT PG. 336	 SEAL NUT PG. 336	 MEGA WRENCH PG. 368
-----------------------	-------------------------	-------------------------	----------------------------



MEGA NEW BABY CHUCK

CLAMPING RANGE: ϕ .010"-1.000" For Drills, Reamers, Taps & Finishing End Mills

MAX
35,000
RPM

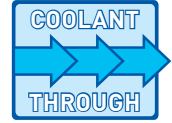

A.1
BCV/CV

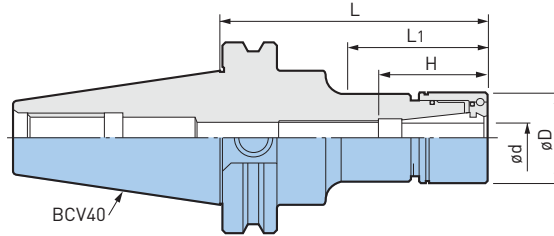

Catalog Number	ϕd	ϕD	L	L1	H	Collet	Nut	Wrench	Max RPM	Weight (lbs.)
BCV40-MEGA6N-2.5	.010-.236	.787	2.50	1.04	.91-1.69	NBC6-□	MGN6	MGR20	35,000	2.3
-4			4.00	2.22					30,000	2.5
-5			5.00	3.22					20,000	2.7
-6			6.00	4.22					15,000	2.8
-MEGA8N-2.5	.020-.315	.984	2.50	1.04	1.02-1.77	NBC8-□	MGN8	MGR25	35,000	2.4
-4			4.00	2.30					30,000	2.7
-5			5.00	3.30					20,000	2.9
-6			6.00	4.30					15,000	3.1
-MEGA10N-2.5	.059-.394	1.181	2.50	1.05	1.50-1.89	NBC10-□	MGN10	MGR30	35,000	2.5
-4			4.00	2.38					25,000	3.0
-5			5.00	3.38					20,000	3.2
-6			6.00	4.38					15,000	3.5
-MEGA13N-2.5	.098-.512	1.387	2.50	1.17	1.73-2.48	NBC13-□	MGN13	MGR35	30,000	2.7
-4			4.00	2.46					25,000	3.2
-5			5.00	3.46					20,000	3.5
-6			6.00	4.46					15,000	4.0
-MEGA16N-2.5	.098-.630	1.654	2.50	1.18	1.89-2.48	NBC16-□	MGN16	MGR42	30,000	2.9
-4			4.00	2.62	20,000				3.6	
-5			5.00	3.62	15,000				4.2	
-6			6.00	4.62	12,000				4.7	
-MEGA20N-2.5	.098-.787	1.811	2.50	1.75	2.01	NBC20-□	MGN20	MGR46	30,000	3.0
-4			4.00	3.25	20,000				4.0	
-5			5.00	4.25	15,000				4.6	
-6			6.00	5.25	12,000				5.3	
-MEGA25N-3	.610-1.000	2.362	3.00	2.25	2.52-2.91	NBC25-□	MGN25	MGR60L	25,000	3.2
-4			4.00	3.25					20,000	4.1

- MEGA NEW BABY NUT is included, collet, wrench and adjusting screw must be ordered separately
- Weight includes nut but not collet
- Center through coolant supply is available
- Please note that the practical spindle speed may be considerably influenced by the machine rigidity and tool balance, when using, slowly ramp up to the appropriate speed starting from slow speeds
- "H" indicates the adjustment length with an adjusting screw
- "H" dimension is the Max tool shank length that can be inserted into the holder

ACCESSORIES



MEGA NEW BABY CHUCK

CLAMPING RANGE: ϕ .010"-1.000" For Drills, Reamers, Taps & Finishing End Mills

MAX
20,000
RPM

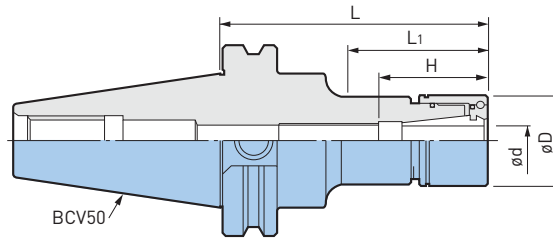
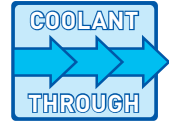

Catalog Number	ϕd	ϕD	L	L ₁	H	Collet	Nut	Wrench	Max RPM	Weight (lbs.)
BCV50-MEGA6N-3.5	.010-.236	.787	3.50	1.72	.91-1.69	NBC6-□	MGN6	MGR20	20,000	7.0
-5			5.00	3.03					20,000	7.1
-6			6.00	4.03					15,000	7.3
-MEGA8N-3.5	.020-.315	.984	3.50	1.72	1.02-1.77	NBC8-□	MGN8	MGR25	20,000	7.1
-5			5.00	3.03					20,000	7.4
-6			6.00	4.03					15,000	7.6
-MEGA10N-3.5	.059-.394	1.181	3.50	1.72	1.50-1.89	NBC10-□	MGN10	MGR30	20,000	7.3
-5			5.00	3.03					20,000	7.7
-6			6.00	4.03					15,000	7.9
-8			8.00	6.03					12,000	8.6
-MEGA13N-3.5	.098-.512	1.378	3.50	1.72	1.73-2.48	NBC13-□	MGN13	MGR35	18,000	7.5
-5			5.00	3.22					18,000	8.1
-6			6.00	4.03					16,000	8.5
-8			8.00	6.03					12,000	9.3
-MEGA16N-3.5	.098-.630	1.654	3.50	1.72	1.89-2.68	NBC16-□	MGN16	MGR42	17,000	7.8
-5			5.00	3.22					17,000	8.7
-6			6.00	4.22					16,000	9.3
-8			8.00	6.22					13,000	10.4
-MEGA20N-3.5	.098-.787	1.811	3.50	1.80	2.01-2.68	NBC20-□	MGN20	MGR46	16,000	8.1
-5			5.00	3.22					16,000	9.0
-6			6.00	4.22					15,000	9.7
-8			8.00	6.22					13,000	11.0
-MEGA25N-4	.610-1.000	2.362	4.00	2.50	2.52-2.91	NBC25-□	MGN25	MGR60L	15,000	8.8
-6			6.00	4.50					13,000	10.9

- MEGA NEW BABY NUT is included, collet, wrench and adjusting screw must be ordered separately
- Weight includes nut but not collet
- Center through coolant supply is available
- Please note that the practical spindle speed may be considerably influenced by the machine rigidity and tool balance, when using, slowly ramp up to the appropriate speed starting from slow speeds
- "H" indicates the adjustment length with an adjusting screw

ACCESSORIES



MEGA ER GRIP

CLAMPING RANGE: ϕ .075"-.787" For Drills, Reamers, Taps & Finishing End Mills

MAX
35,000
RPM

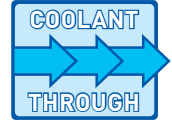

A.1
BCV/CV

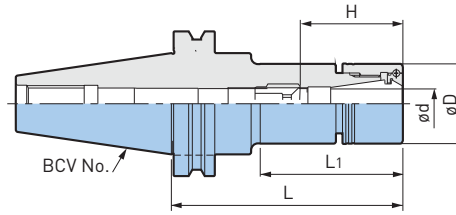
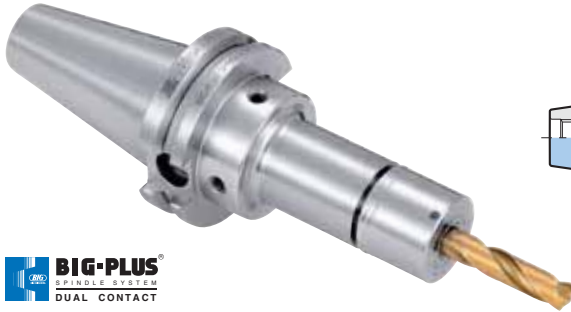

Catalog Number	ϕ d	ϕ D	L	L1	H	Collet	Nut (NOT Included)	Wrench	Max RPM	Weight (lbs.)
BCV40-MEGAER11-4NL	.108-.236	.787	4.00	2.48	.91-1.69	ERC11-□	MERN11*	MGR20	30,000	2.5
-MEGAER16-3NL	.075-.394	1.181	3.00	1.50	1.38-1.85	ERC16-□	MERN16*	MGR30L	35,000	3.1
-4NL			4.00	2.48					25,000	3.3
-5NL			5.00	3.46					20,000	3.5
-6NL			6.00	4.49					15,000	4.0
-MEGAER20-3NL			.108-.512	1.378					3.00	1.50
-4NL	4.00	2.48			25,000	3.5				
-5NL	5.00	3.50			20,000	4.0				
-6NL	6.00	4.49			15,000	4.2				
-MEGAER25-3NL	.108-.630	1.654	3.00	1.61	1.73-2.56	ERC25-o	MERN25*	MGR42L	30,000	3.5
-4NL			4.00	2.60	1.73-2.64				20,000	4.0
-5NL			5.00	3.58					15,000	4.4
-6NL			6.00	4.61					12,000	4.8
-MEGAER32-3.25NL	.108-.787	1.969	3.25	—		1.97-2.68	ERC32-□	MERN32*	MGR50L	30,000
-4NL			4.00		20,000					4.4
-5NL			5.00		15,000					5.1
-6NL			6.00		12,000					5.9
BCV50-MEGAER16-3.5NL	.075-.394	1.181	3.50	1.85	1.39-1.84	ERC16-□	MERN16*	MGR30L	20,000	8.4
-5NL			5.00	3.35					20,000	8.8
-6NL			6.00	4.33					15,000	9.0
-MEGAER20-3.5NL	.108-.512	1.378	3.50	1.85	1.65-2.43	ERC20-□	MERN20*	MGR35L	18,000	8.6
-5NL			5.00	3.35					18,000	9.0
-6NL			6.00	4.33					16,000	9.5
-MEGAER25-3.5NL	.108-.630	1.654	3.50	1.85	1.74-2.65	ERC25-□	MERN25*	MGR42L	17,000	8.8
-5NL			5.00	3.35					17,000	9.5
-6NL			6.00	4.33					16,000	9.9
-MEGAER32-3.5NL	.108-.787	1.969	3.50	1.89	1.97-2.68	ERC32-□	MERN32*	MGR50L	16,000	9.0
-5NL			5.00	3.39					16,000	10.1
-6NL			6.00	4.37					15,000	11.0

*Nut, adjusting screw, balance screws, collet and wrench are not included

- Weight does not include collet
- MEGA ER GRIP is not able to use DIN6499 Form-A collets and ESX collets
- Please note that the practical spindle speed may be considerably influenced by the machine rigidity and tool balance, when using, slowly ramp up to the appropriate speed starting from slow speeds
- "H" indicates the adjustment length with an adjusting screw

CAUTION

To maintain the accuracy of the tool assembly, do not use collets and nuts manufactured by another company with the chuck body of BIG's MEGA ER GRIP. We cannot guarantee the accuracy statement for our collets if they are assembled on the chuck body of another manufacturer.

ACCESSORIES



*MEGA NUT is the recommended nut to achieve high accuracy and clamping force

MEGA E CHUCK

CLAMPING RANGE: ϕ .125"-.500" (ϕ 3-12mm)
Exclusively for High Speed Finish End Milling

**MAX
35,000
RPM**

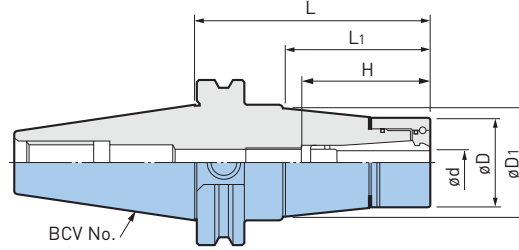
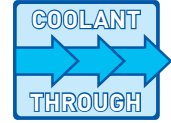

Catalog Number	ϕd	ϕD	$\phi D1$	L	L1	H	Collet	Nut	Wrench	Max RPM	Weight (lbs.)
BCV40-MEGA6E-3	.125-.250 (3-6mm)	.984	1.09	3.00	1.50	1.45-1.77	MEC6-□	MEN6	MGR25	35,000	2.5
-4			1.25	4.00	2.42					29,000	3.0
-5			1.45	5.00	3.54					29,000	3.4
-6			1.50	6.00	4.54					20,000	3.8
-MEGA8E-3	.125-.250 (3-8mm)	1.181	1.28	3.00	1.50	1.65-2.00	MEC8-□	MEN8	MGR30	30,000	2.8
-4			1.46	4.00	2.54					29,000	3.2
-5			1.55	5.00	3.58					29,000	3.6
-6			1.69	6.00	4.58					20,000	4.3
-MEGA10E-3	.125-.375 (3-10mm)	1.378	1.48	3.00	1.54	1.89-2.28	MEC10-□	MEN10	MGR35	30,000	2.9
-4			1.65	4.00	2.58					29,000	3.4
-5			1.65	5.00	3.58					29,000	3.9
-6			1.65	6.00	4.58					22,000	4.5
-8			1.65	8.00	6.62					16,000	5.2
-MEGA13E-3	.125-.500 (3-12mm)	1.654	1.65	3.00	1.62	1.96-2.36	MEC13-□	MEN13	MGR42	30,000	3.2
-4			1.65	4.00	2.62					29,000	3.8
-5			1.65	5.00	3.62					29,000	4.3
-6			1.65	6.00	4.62					22,000	4.9
-8			1.65	8.00	6.62					16,000	6.1
BCV50-MEGA13E-4	.125-.500 (3-12mm)	1.654	1.90	4.00	2.42	1.96-2.36	MEC13-□	MEN13	MGR42	18,000	8.5
-5			2.07	5.00	3.42					18,000	9.3
-6			2.25	6.00	4.42					16,000	10.6
-8			2.42	8.00	6.50					12,000	12.8

- MEGA E NUT is included, collet, wrench and adjusting screw must be ordered separately
- Weight includes nut but not collet
- Center through coolant supply is available
- Please note that the practical spindle speed may be considerably influenced by the machine rigidity and tool balance, when using, slowly ramp up to the appropriate speed starting from slow speeds
- "H" indicates the adjustment length with an adjusting screw

ACCESSORIES



MEGA DOUBLE POWER CHUCK

CLAMPING RANGE: ϕ .625"-1.500"

For Heavy Duty End Milling

**MAX
30,000
RPM**

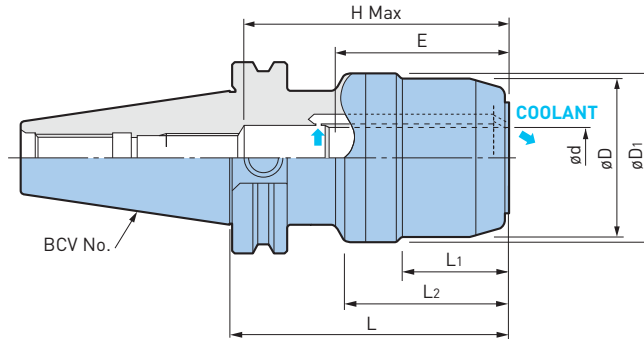
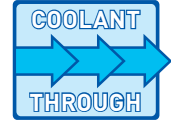

A.1
BCV/CV

Catalog Number	ϕd	ϕD	ϕD_1	L	L ₁	L ₂	H	Min Clamping Length E	Wrench	Max RPM	Weight (lbs.)
BCV40-MEGA.625DS-3.5A	.625	1.654	2.071	3.59	1.06	2.01	2.88	2.13	MGR42L	30,000	3.9
-MEGA.750DS-3.5A	.750	1.969	2.193	3.59	1.40	2.09	3.44	2.25	MGR50L	30,000	4.0
-MEGA1.000DS-3.5A	1.000	2.441	2.469	3.59	1.61	2.09	3.44	2.50	MGR62L	27,000	4.6
-MEGA1.250DS-4A	1.250	2.756	2.783	4.09	1.42	2.36	3.63	2.75	MGR70L	26,000	5.1
BCV50-MEGA.625DS-4	.625	1.811	2.165	4.09	1.02	1.42	2.88	2.13	MGR46L	21,000	8.8
-6				6.09		1.42					
-MEGA.750DS-4	.750	2.362	2.717	4.09	1.10	2.72	3.44	2.25	MGR60L	20,000	9.9
-6				6.09		4.72					
-MEGA1.000DS-4	1.000	2.756	3.031	4.09	1.34	2.58	3.63	2.50	MGR70L	20,000	10.6
-6				6.09		4.58					
-MEGA1.250DS-4	1.250	3.150	3.386	4.09	1.65	2.53	4.22	2.75	MGR80L	20,000	11.3
-6				6.09		4.53					
-MEGA1.500DS-4.5	1.500	3.898	3.925	4.58	1.65	2.86	4.29	2.75	MGR99L	15,000	14.6

- Wrench must be ordered separately
- Please note that the practical spindle speed may be considerably influenced by the machine rigidity and tool balance, when using, slowly ramp up to the appropriate speed starting from slow speeds
- "H" indicates the adjustment length with an adjusting screw
- "H" dimension is the Max tool shank length that can be inserted into the holder
- MEGA16DS requires the hex socket head screw (M8) for axial adjustment, however, please contact us if using for center through applications
- DS types have jet-through coolant supply, thus tools with holes cannot be used

ACCESSORIES

<p>COLLET PG. 364</p>	<p>PERFECT SEAL/ JET COLLET PG. 361</p>	<p>MEGA WRENCH PG. 368</p>	<p>SCREW PG. 390</p>
---------------------------	---	--------------------------------	--------------------------

MEGA DOUBLE POWER CHUCK

CLAMPING RANGE: ϕ .625"-1.500"

High Rigidity Type for Heavy Duty End Milling

HIGHER RIGIDITY

MAX 30,000 RPM

COOLANT THROUGH

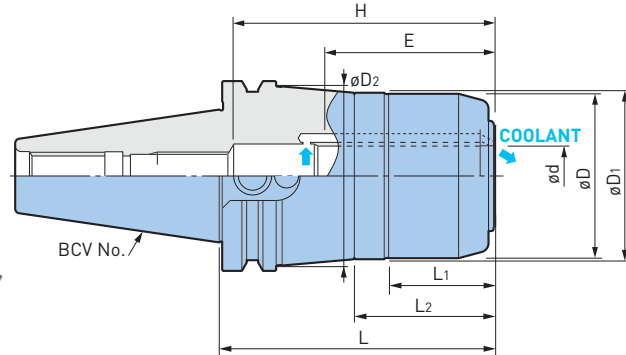

Catalog Number	ϕd	ϕD	$\phi D1$	$\phi D2$	L	L1	L2	H	Min Clamping Length E	Wrench	Max RPM	Weight (lbs.)
BCV40H-MEGA.625DS-3.5A	.625	1.654	2.071	2.39	3.59	1.06	1.42	2.87	2.25	MGR42L	30,000	3.6
-MEGA.750DS-3.5A	.750	1.969	2.193	2.39	3.59	1.40	1.85	3.44	2.29	MGR50L	30,000	4.0
-MEGA1.000DS-3.5A	1.000	2.441	2.469	—	3.59	1.61	—	3.42	2.33	MGR62L	27,000	4.6
-MEGA1.250DS-4A	1.250	2.756	2.783	—	4.09	1.42	—	3.63	2.64	MGR70L	26,000	5.1
BCV50H-MEGA.750DS-4	.750	2.362	2.717	2.99	4.09	1.10	1.51	3.44	2.29	MGR60L	20,000	9.9
-6				3.09	6.09						17,000	13.0
-MEGA1.000DS-4	1.000	2.756	3.031	3.32	4.09	1.34	1.87	3.63	2.64	MGR70L	20,000	10.6
-6				3.32	6.09						17,000	14.3
-MEGA1.250DS-4	1.250	3.150	3.386	3.57	4.09	1.65	2.23	4.22	2.88	MGR80L	20,000	11.3
-6				3.57	6.09						15,000	15.9
-MEGA1.500DS-4.5	1.500	3.898	3.925	—	4.58	1.65	—	4.29	2.88	MGR99L	15,000	14.6

- Wrench must be ordered separately
- Please note that the practical spindle speed may be considerably influenced by the machine rigidity and tool balance, when using, slowly ramp up to the appropriate speed starting from slow speeds
- "H" indicates the adjustment length with an adjusting screw
- "H" dimension is the Max tool shank length that can be inserted into the holder
- MEGA16DS requires the hex socket head screw (M8) for axial adjustment, however, please contact us if using for center through applications
- DS types have jet-through coolant supply, thus tools with holes cannot be used

ACCESSORIES



CAUTION

H type conforms to ASME B5.50-2015 standard for safe zone. Interference with tool changer may occur on machines made to an older standard. Consult engineering for specific information about the intended machine.

MEGA PERFECT GRIP

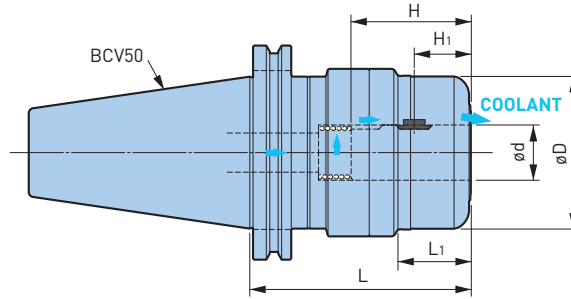
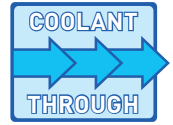

Catalog Number	ød	øD	L	L1	H	H1	Wrench	Weight (lbs.)
BCV50-MEGA.750DPG-4	.750	2.362	4.000	1.062	1.929	.913	MGR60L	9.9
-MEGA1.000DPG-4	1.000	2.756	4.000	1.299	2.165	1.024	MGR70L	10.6
-MEGA1.250DPG-4.25	1.250	3.150	4.250	1.614	2.244	1.102	MGR80L	12.3

- Key grip and spring are included, wrench must be ordered separately
- H1 is the dimension from the center of the Key Grip to the front end of the chuck

CAUTION ⚠

Always replace worn or damaged Key Grips immediately for safe operation

Clamping ø	Key Grip (2 pcs.)	Spring
.750	PKG.750-2P	PSP1823
1.000	PKG1.000-2P	PSP2420
1.250	PKG1.250-2P	PSP3128

- Spare Key Grips are available in 2 pcs. per set

CYLINDRICAL SHANK WITH FLAT SECTION

The following standard shank is required for MEGA PERFECT GRIP.

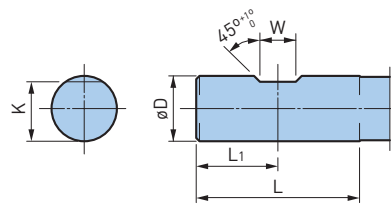
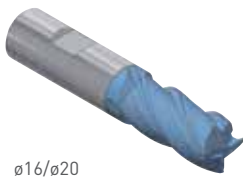

øD		L	L1	W		K	
Nominal	Tolerance			Nominal	Tolerance	Nominal	Tolerance
.750	-.0001 -.0005	2.032	1.016	.455	+.002 -0	.675	+0 -.016
1.000		2.281	1.141	.515		.925	
1.250						1.156	

- Please contact your cutting tool supplier for conformance to this standard. Reprinted from ASME B94.19-1997, by permission of The American Society of Mechanical Engineers. All rights reserved.

CAUTION ⚠

In case you are adding your own flat, the tool projection length in the MEGA PERFECT GRIP will be decided by the flat position. Refer to H1 in the MEGA PERFECT GRIP chart, decide the flat position to add, and then cut the cutter at L1 on cutter shank.

NEW Hi-POWER MILLING CHUCK

CLAMPING RANGE: \varnothing .750"-1.500"

For Heavy Duty End Milling

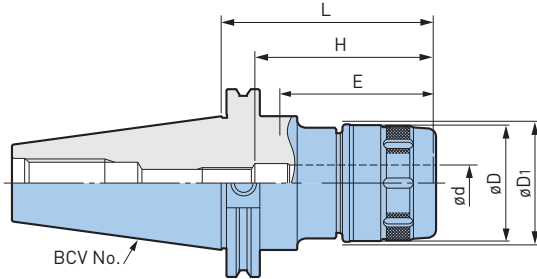
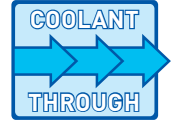

Catalog Number	$\varnothing d$	$\varnothing D$	$\varnothing D_1$	L	H	Min Clamping Length E	Wrench	Weight (lbs.)
BCV40-HMC.750S-3.5	.750	1.969	2.008	3.50	3.34	2.25	FK45-50L	3.4
-HMC1.000S-3.5	1.000	2.323	2.362	3.50	3.42	2.50	FK58-62L	4.2
-HMC1.250S-4	1.250	2.677	2.717	4.00	3.54	2.75	FK68-75L	4.7
-HMC20S-85	20mm	1.969	1.996	3.35	2.72-3.11	2.20	FK45-50L	3.4
-HMC32S-100	32mm	2.677	2.705	3.94	3.03-3.42	2.52	FK68-75L	4.4
BCV50-HMC.750-4	.750	2.362	2.402	4.00	3.34	2.25	FK58-62	9.3
-HMC1.000-4	1.000	2.441	2.480	4.00	3.54	2.50	FK58-62	8.9
-HMC1.250-4	1.250	3.150	3.189	4.00	4.13	2.75	FK80-90	10.2
-HMC1.500-4.5	1.500	3.898	3.937	4.50	4.21	2.75	FK92-100	13.2
-HMC20S-105	20mm	1.969	1.996	4.13	2.72-3.11	2.20	FK45-50L	8.4
-HMC32S-105	32mm	2.677	2.705	4.13	3.46-3.86	2.83	FK68-75L	9.6

- Wrench and axial adjusting screw must be ordered separately
- When using center through coolant:
 - Set screw with sealing compound applied (standard accessory) should be used to plug an air bleeding hole
 - Oil hole type should be chosen when straight collet is required
- "H" indicates the adjustment length with an adjusting screw
- "H" dimension is the Max tool shank length that can be inserted into the holder

ACCESSORIES

 COLLET PG. 364	 PERFECT SEAL/ JET COLLET PG. 361	 WRENCH PG. 367	 SCREW PG. 390
---	---	---	--

NEW Hi-POWER MILLING CHUCK

CLAMPING RANGE: \varnothing .500"

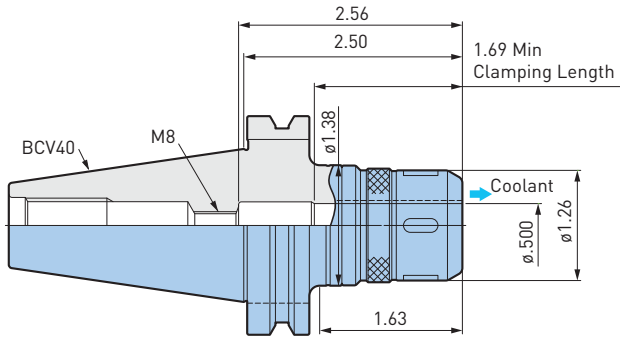

Catalog Number	Wrench	Weight (lbs.)
BCV40-HMC.500J-2.5	FK31-33	2.4

• Wrench must be ordered separately

ACCESSORIES

 <p>PERFECT SEAL/ JET COLLET PG. 362</p> 	 <p>WRENCH PG. 367</p> 
---	---

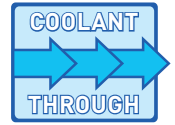
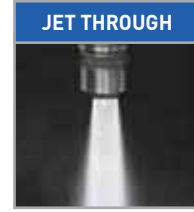

A.1
BCV/CV

SUPER SLIM TYPE

CLAMPING RANGE: $\varnothing 6$ -12mm

For Drills, Reamers, Ball Mills, End Mills, Diamond Reamers & Grinding Tools

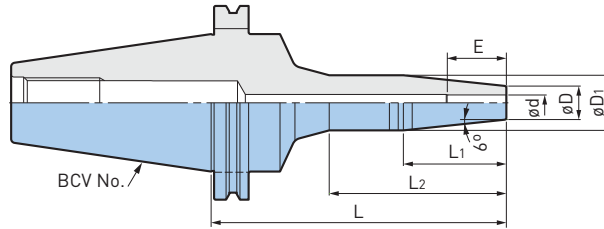
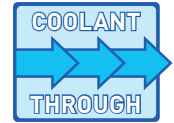

Catalog Number	$\varnothing d$	$\varnothing D$	$\varnothing D_1$	L	L ₁	L ₂	Min Clamping Length E	Max RPM	Weight (lbs.)
BCV40-HDC6S-125	6mm	.551	1.024	4.92	2.24	3.34	.99	30,000	2.9
-HDC8S-125	8mm	.669	1.102		2.05	3.38	1.18	30,000	2.9
-HDC10S-125	10mm	.748	1.181		3.42	1.38	28,000	3.1	
-HDC12S-125	12mm	.827	1.260		3.42	1.38	28,000	3.1	
BCV50-HDC6S-150	6mm	.551	1.024	5.91	2.24	3.54	.99	20,000	7.7
-HDC8S-150	8mm	.669	1.102		2.05	3.66	1.18	20,000	7.9
-HDC10S-150	10mm	.748	1.181		3.74	1.26	20,000	7.9	
-HDC12S-150	12mm	.827	1.260		3.74	1.38	20,000	8.1	

• Adjusting Screw cannot be used

CAUTION

Use only cutting tools that have a shank tolerance of h6 (see table Pg. 26). Do not use with cutting tools made with a flat on the shank (ie: Weldon type shank). Roughing end mills are not recommended for use with HYDRAULIC CHUCKS. Do not tighten the clamping screw without first inserting a cutting tool into the tool holder. Always insert the cutting tool into the hydraulic tool holder beyond min. clamping length "E".



CLAMPING RANGE: ϕ .250"-1.250" (ϕ 20mm)

For Drills, Reamers, Ball Mills, End Mills, Diamond Reamers & Grinding Tools

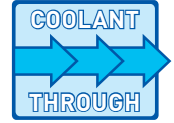

A.1
BCV/CV

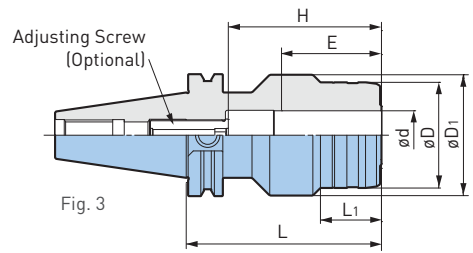
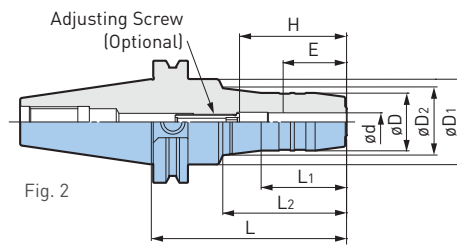
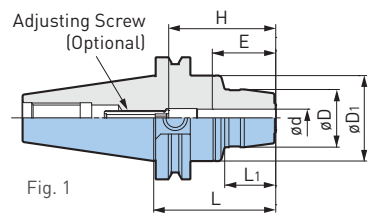

Catalog Number	Fig.	ϕd	ϕD	ϕD_1	ϕD_2	L	L ₁	L ₂	H	Min Clamping Length E	Adjusting Screw	Weight (lbs.)
BCV40-HDC.250-2.5	1	.250	1.024	1.750	—	2.50	1.02	—	1.10-1.97	1.10	HDA6-05032	2.4
-4	1.20				4.00	1.75	2.48	3.1				
-5.5	1.75				5.50	1.75	4.09	3.8				
-HDC.375-2.5	1	.375	1.181	1.750	—	2.50	1.04	—	1.30-2.17	1.30	HDA10-08032	2.7
-4	1.37				4.00	1.75	2.52	3.1				
-5.5	1.75				5.50	1.75	4.09	4.0				
-HDC.500-2.5	1	.500	1.299	1.750	—	2.50	.98	—	1.50-2.36	1.50	HDA12-10032	2.7
-4	1.75				4.00	1.75	2.60	3.3				
-5.5	—				5.50	1.75	4.09	4.0				
-HDC.625-3	1	.625	1.496	1.750	1.75	3.00	1.54	—	1.69-2.76	1.69	HDA16-12030	2.9
-4	4.00					2.00	2.60	3.3				
-5.5	5.50					2.00	—	4.2				
-HDC.750-3	1	.750	1.654	1.750	—	3.00	1.57	2.60	1.69-2.76	1.69	HDA16-12030	3.1
-4	4.00				2.00	4.09	3.6					
-5.5	5.50				2.00	4.13	4.4					
-HDC1.000-3	3	1.000	2.165	2.480	—	3.00	.61	—	2.05-3.15	2.05	HDA16-12015	4.0
-4						4.00	1.25	—				4.7
-5						5.00	1.75	—				5.8
-HDC1.250-4	3	1.250	2.677	2.953	—	4.00	1.25	—	2.20-3.15	2.20	HDA25-16039	5.8
-HDC20-90	2	20mm	1.653	1.750	—	3.54	1.58	—	1.69-2.76	1.69	HDA16-12037	4.4

• Adjustable cutter length H is the adjustable length in the use of adjusting screw

ACCESSORIES



CAUTION

Use only cutting tools that have a shank tolerance of h6 (see table Pg. 26). Do not use with cutting tools made with a flat on the shank (ie: Weldon type shank). Roughing end mills are not recommended for use with HYDRAULIC CHUCKS. Do not tighten the clamping screw without first inserting a cutting tool into the tool holder. Always insert the cutting tool into the hydraulic tool holder beyond min. clamping length "E".

CLAMPING RANGE: ϕ .250"-1.250" (ϕ 32mm)

For Drills, Reamers, Ball Mills, End Mills, Diamond Reamers & Grinding Tools

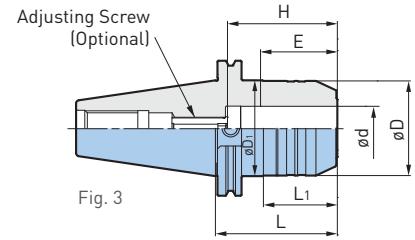
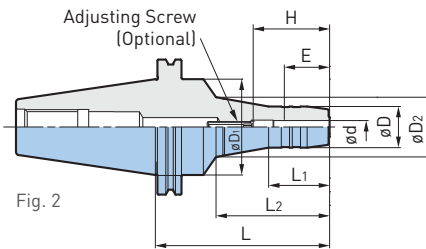
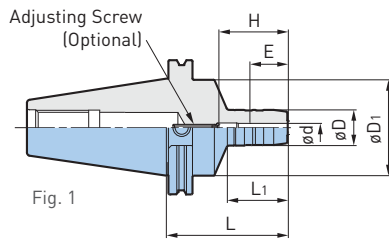
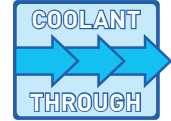

Catalog Number	Fig.	ϕd	ϕD	$\phi D1$	$\phi D2$	L	L1	L2	H	Min Clamping Length E	Adjusting Screw	Weight (lbs.)
BCV50-HDC.250-3.5	1	.250	1.024	2.750	—	3.50	1.75	—	1.10-1.97	1.10	HDA6-05032	7.3
-5	1.53				5.00	3.19		8.0				
-6.5	2.13				6.50	4.92		9.1				
-HDC.375-3.5	1	.375	1.181	2.750	—	3.50	1.75	—	1.30-2.17	1.30	HDA10-08032	7.3
-5	1.71				5.00	3.27		8.0				
-6.5	2.31				6.50	4.96		9.3				
-HDC.500-3.5	1	.500	1.299	2.750	—	3.50	1.75	—	1.50-2.36	1.50	HDA12-10032	7.6
-5	1.85				5.00	3.31		8.2				
-6.5	2.45				6.50	5.00		9.6				
-HDC.625-3.5	1	.625	1.496	2.750	—	3.50	1.75	—	1.69-2.76	1.69	HDA16-12037	7.8
-5	1.97				5.00	3.35		8.7				
-6.5	2.57				6.50	—		10.2				
-HDC.750-3.5	1	.750	1.654	2.750	—	3.50	1.75	3.43	1.69-2.76	1.69	HDA16-12037	8.0
-5	2.15				5.00	5.04		8.9				
-6.5	2.75				6.50	5.12		10.7				
-HDC1.000-3.5	3	1.000	2.480	2.750	—	3.50	2.03	—	2.05-3.15	2.05	HDA25-16039	8.9
-5						5.00	3.54					10.7
-6.5						6.50	5.04					12.7
-HDC1.250-3.5	3	1.250	2.717	2.750	—	3.50	2.09	—	2.20-3.15	2.20	HDA25-16039	10.6
-5						5.00	3.58					11.8
-6.5						6.50	5.08					14.4
-HDC32-90	3	32mm	2.677	2.953	—	3.54	2.13	—	2.20-3.15	2.20	HDA25-16039	9.6

• "H" indicates the adjustment length with an adjusting screw

CAUTION

Use only cutting tools that have a shank tolerance of h6 (see table Pg. 26). Do not use with cutting tools made with a flat on the shank (ie: Weldon type shank). Roughing end mills are not recommended for use with HYDRAULIC CHUCKS. Do not tighten the clamping screw without first inserting a cutting tool into the tool holder. Always insert the cutting tool into the hydraulic tool holder beyond min. clamping length "E".

ACCESSORIES



SHRINK FIT HOLDER

CLAMPING RANGE: \varnothing .250"-1.250" (\varnothing 8-12mm)

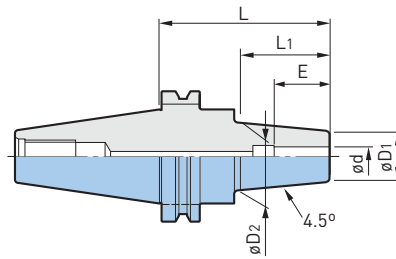

Catalog Number	$\varnothing d$	$\varnothing D1$	$\varnothing D2$	L	L1	Min Clamping Length E	Weight (lbs.)
BCV40-SF.250-3.5	.250	.787	1.06	3.50	1.50	.87	2.6
-SF.375-3.5	.375	.945	1.26		2.00	1.22	2.7
-SF.500-3.5	.500				1.42	2.7	
-6				6.00			3.4
-SF.625-3.5	.625	1.063	1.34	3.50	1.50	1.54	2.7
-6				6.00			3.6
-SF.750-4	.750	1.299	1.65	4.00	2.25	1.85	3.1
-6				6.00			4.2
-SF1.000-4				4.00			3.8
-6	1.000	1.732	2.09	6.00			5.6
BCV40-SF8-80	8mm	.827	1.06	3.15	2.17	1.02	2.2
-SF10-80	10mm	.945	1.26	3.15	2.17	1.22	2.4
-SF12-80	12mm	.945	1.26	3.15	2.17	1.42	2.4
BCV50-SF.500-4	.500	.945	1.26	4.00	2.00	1.42	7.2
-SF.625-4	.625	1.063	1.34	4.00	1.75	1.54	7.5
-SF.750-4	.750	1.299	1.65	4.00	2.27	1.61	7.7
-6				6.00			8.8
-SF1.000-4	1.000	1.732	2.09	4.00	2.27	1.85	8.4
-6				6.00			10.2
-SF1.250-4	1.250	1.732	2.09	4.00	2.27	2.01	8.1
-6				6.00			9.8

- Use a carbide shank cutter within a tolerance of h6
- Center through coolant supply is available with tools with oil holes

CAUTION

Please refer to the operation manual of heating/cooling equipment, as some equipment may not be compatible.

SHELL/FACE MILL HOLDER

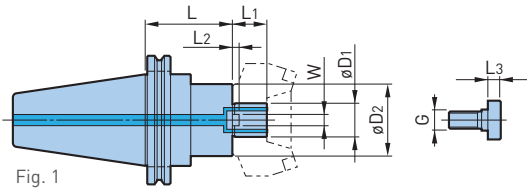
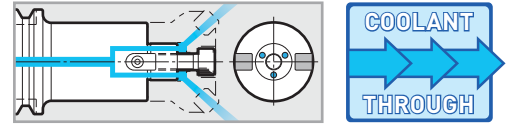

Fig. 1

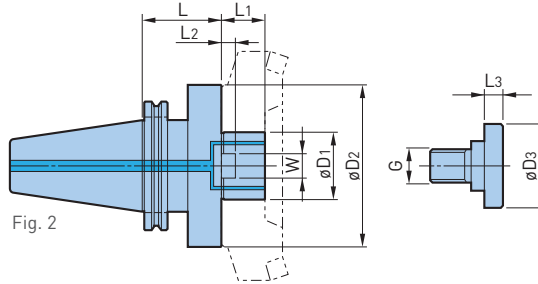

Fig. 2

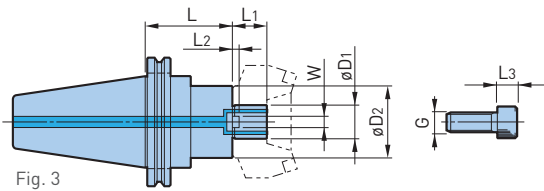

Fig. 3

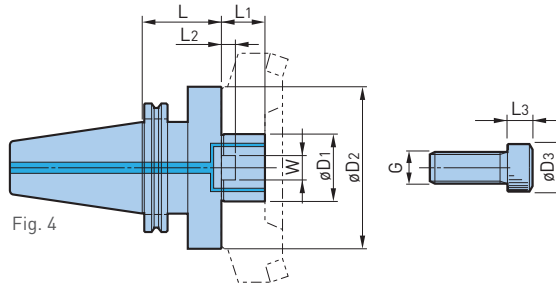

Fig. 4



Catalog Number	Fig.	øD1	øD2	øD3	L	L1	L2	L3	W	G	Weight (lbs.)
BCV40-SMC.750-2	1	.750	1.689	.88	2.00		.16		.313	3/8"-24	2.7
-4					4.00						4.0
-6					6.00						5.2
-SMC1.000-2	2	1.000	2.189	1.12	2.00	.69	.22	.38	.375	1/2"-20	3.1
-4					4.00						4.4
-6					6.00		5.6				
-SMC1.250-2							1.250	2.752	1.50	2.00	.28
-SMC1.500-2		1.500	3.626	1.86		.93	.38	.625	3/4"-16	4.8	
-FMH22-47-50	3	22mm	1.850	.63	1.97	.71	.20	.39	.394	M10x1.5	2.8
-60-50		2.362	.71			.24	.47	.472	M12x1.75	3.5	
-FMH27-76-50	4	27mm	2.992	.71		.87	.28	.63	.551	M16x2	3.5
-FMH32-76-50		32mm	2.992	.94							

Catalog Number	Fig.	øD1	øD2	øD3	L	L1	L2	L3	W	G	Weight (lbs.)	
BCV50-SMC.750-2	1	.750	1.689	.88	2.00	.69	.16	.38	.313	3/8"-24	7.4	
-4					4.00						8.7	
-6					6.00						9.9	
-SMC1.000-2		1	1.000	2.189	1.12		2.00		.22	.375	1/2"-20	7.6
-4							4.00					9.6
-6							6.00					11.7
-8							8.00					13.7
-10							10.00					15.7
-12							12.00					17.7
-SMC1.250-2		1	1.250	2.752	1.50		2.00		.28	.500	5/8"-18	8.2
-4							4.00					11.4
-6							6.00					14.6
-8	8.00					17.8						
-10	10.00					20.5						
-12	12.00					23.7						
-SMC1.500-2	2	1.500	3.626	1.88	2.00	.93	.38	.50	3/4"-16	9.2		
-4					4.00					12.8		
-6					6.00					16.0		
-8					8.00					25.5		
-10					10.00					31.1		
-12					12.00					37.0		
-SMC2.000-2.5	2	2.000	4.874	2.50	2.50	.44	.750	1"-14	11.1			
-4					4.00				16.0			
-6					6.00				25.5			
-SMC2.500-2.5	2	2.500	4.874	3.13	2.50	1.13	1.000	1"-14	13.7			
-FMH22-47-50	3	22mm	1.850	.63	1.97	.71	.20	.39	.394	M10x1.5	7.4	
-60-50			2.362								7.7	
-FMH27-76-50	4	27mm	2.992	.71	1.97	.79	.24	.47	.472	M12x1.75	8.0	
-FMH32-76-50	4	32mm	2.992	.94	1.97	.87	.28	.63	.551	M16x2	8.0	
BCV50H-FMH60-90	4	60mm	5.512	—	3.54	1.58	.44	—	1.000	M20x2.5	20.0	

- Cutter clamping screw is included
- The weight does not include the cutter
- If the provided clamping screw is not compatible, separately select one from the clamping screw table on Pg. 390
- When using a cutter without oil holes, an optional clamping screw with a through hole allows coolant supply
- øD2 indicates the smallest mounting surface diameter of the cutter that can be mounted on the arbor, be careful when using a cutter with the mounting diameter considerably smaller than the cutting diameter, as it may not fit

ACCESSORIES



CAUTION

For high speed applications, Shell Mill Holders should be balanced together with the cutters.



HIGH RIGIDITY SHELL MILL HOLDER

BIG KAISER Now Offers Tool Holders That are Compatible with the New 2015 Revision of the ASME B5.50 (CAT) Standard

The elimination of the reduced section past the v-groove greatly improves radial rigidity for higher performance milling applications.

Not all machining centers are capable of accepting the new 2015 revision and caution should be taken before installing these high rigidity tool holders. Always consult your machine tool manual or the machine tool builder for information about tool change requirements.

HIGH RIGIDITY CAT TAPERS

NEW CAT40 STANDARD ASME B5.50-2015

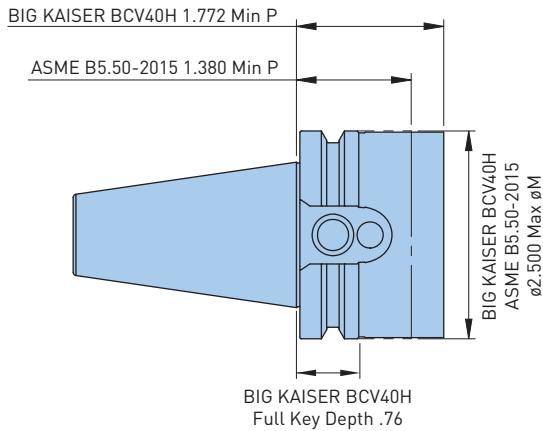

NEW CAT50 STANDARD ASME B5.50-2015

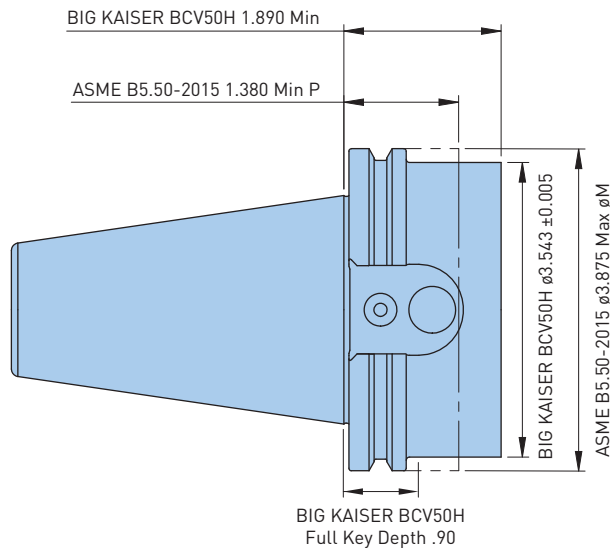

STANDARD CAT TAPERS

OLD CAT40 STANDARD ASME B5.50-1994

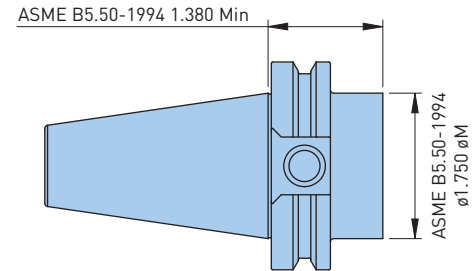

OLD CAT50 STANDARD ASME B5.50-1994

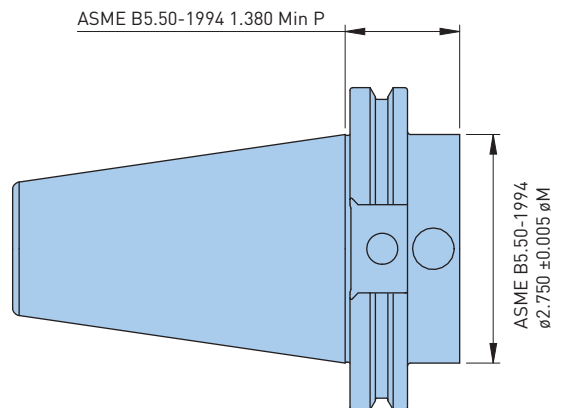

HIGH RIGIDITY SHELL MILL HOLDER

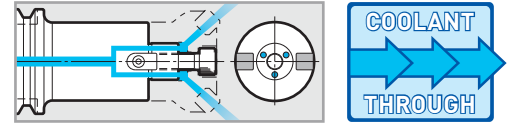

A.1 BCV/CV

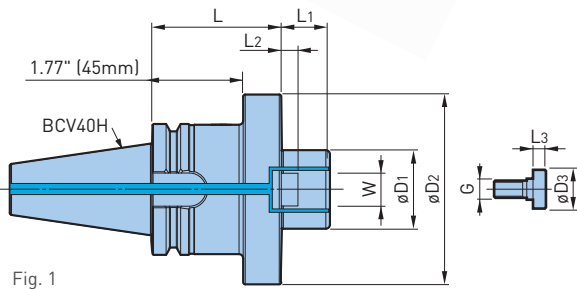

Fig. 1

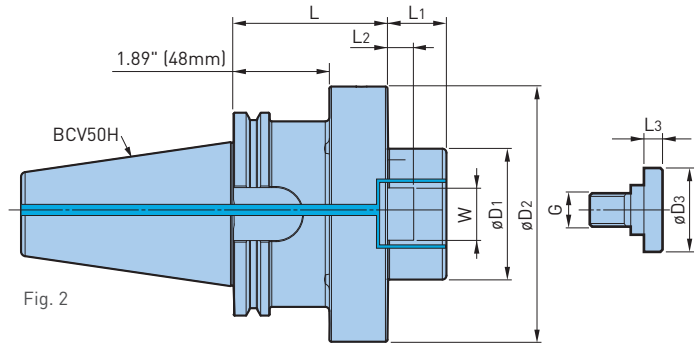

Fig. 2



Catalog Number	Fig.	$\phi D1$	$\phi D2$	$\phi D3$	L	L1	L2	L3	W	G	Weight (lbs.)
BCV40H-SMC1.000-2	1	1.000	2.189	1.12	2.000	.69	.22	.38	.375	1/2"-20	3.3
-SMC1.250-2.5		1.250	2.752	1.50	2.500		.28	.50	.500	5/8"-18	4.7
-SMC1.500-2.5		1.500	3.626	1.88		.93	.38	.625	3/4"-16	6.0	
BCV50H-SMC1.500-4	2	1.500	3.626	1.88	4.000	.93	.38	.50	.625	3/4"-16	15.2
-SMC2.000-4		2.000	4.874	2.50			.44		.750	1"-14	19.4
-SMC2.500-3		2.500		3.13	3.000	1.13		1.000	1"-14	16.6	

CAUTION

H Type conforms to ASME B5.50-2015 standard for safe zone. Interference with tool changer may occur on machines made to an older standard. Consult engineering for specific information about the intended machine.

END MILL HOLDER

CLAMPING RANGE: \varnothing .375"-2.000"

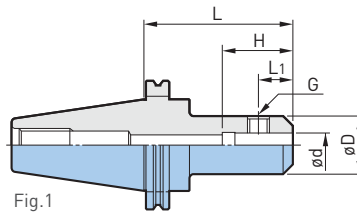

Fig.1

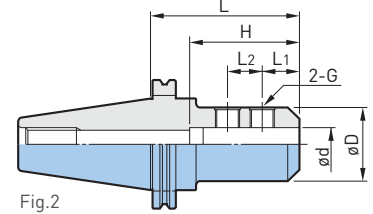

Fig.2

Catalog Number	Fig.	$\varnothing d$	$\varnothing D$	L	L1	L2	H	G	Weight (lbs.)	
BCV40-EM.500-3	1	.500	1.375	3.00	.87	-	3.00	7/16"-20	2.7	
-4.5				4.50					3.3	
-EM.625-3		.625	1.625	3.00	.94		3.50	9/16"-18	2.8	
-4.5				4.50					3.6	
-EM.750-1.5		1	.750	1.750	1.50		1.13	2.25	5/8"-18	2.0
-3					3.00					2.8
-4.5	4.50				3.8					
-EM1.000-3	2	1.000	2.252	3.00	1.13	1.00	3.13	3/4"-16	3.2	
-4.5				4.50					4.8	
-EM1.250-4.5		1.250	2.750	4.50	6.1					
-EM1.500-5				5.00	6.4					
BCV50-EM.375-6	1	.375	1.000	6.00	.75	-	3.00	3/8"-24	7.4	
-EM.500-4.5				.500					1.375	4.50
-6		6.00	8.3							
-EM.625-4.5		.625	1.625	4.50	.94		3.50	9/16"-18	8.0	
-6				6.00					8.8	
-EM.750-4.5		.750	1.750	4.50	1.00		3.88	5/8"-18	8.2	
-6	6.00			9.0						
-EM1.000-4.5	2	1.000	2.252	4.50	1.13	1.00	3.13	3/4"-16	9.1	
-6				6.00					10.5	
-8				8.00					12.5	
-EM1.250-4.5		1.250	2.750	4.50	1.13	1.00	3.13	3/4"-16	10.3	
-6				6.00					12.6	
-8				8.00					15.6	
-EM1.500-4.5		1.500	2.750	4.50	1.13	1.00	3.13	3/4"-16	9.9	
-6				6.00					12.2	
-8				8.00					15.2	
-EM2.000-6		2.000	3.500	6.00	1.38	1.38	4.33	1"-14	14.4	
-EM2.500-6		2.500	3.937	6.00	1.56	1.56	3.74	1"-14	16.3	

• For high speed applications MEGA DOUBLE POWER CHUCKS are recommended instead of End Mill Holders

CAUTION

BIG genuine side lock screws must be used as they are made to an exclusive design and different from other screws on the market.

ACCESSORIES



SMART DAMPER MILLING—FACE MILL ARBOR TYPE

PATENT #
9027720

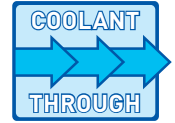

A.1
BCV/CV

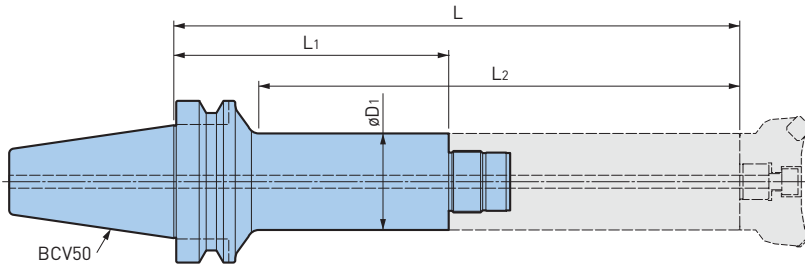

Catalog Number	$\phi D1$	L	L1	L2	Weight (lbs.)	Damper Head Model
BCV50-SDF36-47-170	47mm	13.780	6.693	12.402	12.3	FMH□□DP-47
-60-220	60mm	15.748	8.661	14.370	17.2	FMH□□DP-60

SMART DAMPER MILLING—DAMPER HEAD

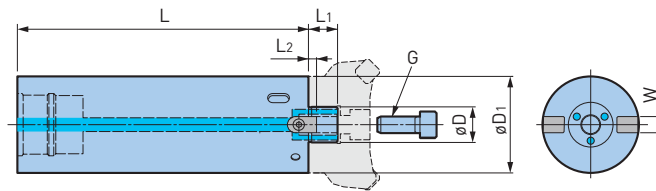
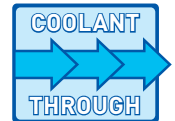

Catalog Number	ϕD	$\phi D1$	L	L1	L2	W	G	Weight (lbs.)	C-Spanner Model
SDF36-FMH22DP-47-180	22mm	1.850	7.087	.709	.197	.394	M10	6.6	FK45-50L
-60-180	22mm	2.362	7.087	.709	.197	.394	M10	9.9	FK58-62L
-FMH27DP-60-180	27mm	2.362	7.087	.709	.236	.472	M12	9.9	
SDF36-SMC.750DP-47-180	.750	1.850	7.087	.689	.160	.313	3/8"-24	6.6	FK45-50L
-SMC1.000DP-60-180	1.000	2.362	7.087	.689	.220	.375	1/2"-20	9.9	FK58-62L

- Hook wrench and cutter clamping screw are included
- The weight does not include the cutter
- Refer to the operation manual regarding the mounting method to the basic holder
- If the provided clamping screw is not compatible, separately select one from the clamping screw table on Pg. 390

MEGA SYNCHRO TAPPING HOLDER

TAPPING RANGE: No.2-AU3/4

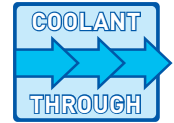
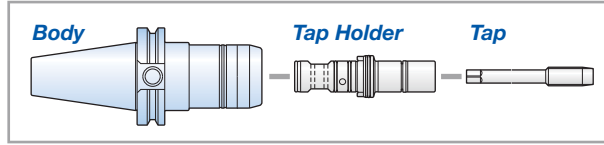

PATENT #
8226337

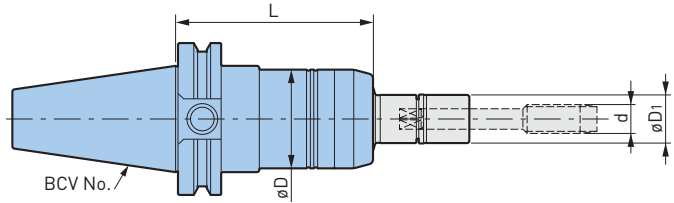

Catalog Number	Tapping Range d (Inch)	Tapping Range d (Metric)	øD	øD1	L	Weight (lbs.)	Wrench
BCV40-MGT6-3.25	No.2-No.12	M2-M6	1.42	.63	3.25	2.9	MGR16
-MGT12-3.25	AU1/4-AU7/16	M6-M12	1.61	.79	3.25	3.1	MGR20L
-MGT20-4.5	AU1/2-AU3/4 AP1/8-AP1/4	M12-M20	2.13	1.18	4.50	4.0	MGR30L
BCV50-MGT6-3.25	No.2-No.12	M2-M6	1.42	.63	3.25	8.6	MGR16
-MGT12-3.25	AU1/4-AU7/16	M6-M12	1.61	.79	3.25	8.8	MGR20L
-MGT20-4	AU1/2-AU3/4 AP1/8-AP1/4	M12-M20	2.13	1.18	4.00	9.7	MGR30L

*AU3/8 is included in the MGT20 series

- MGT set screw is included, tap holder and wrench must be ordered separately

ACCESSORIES



CAUTION

Cannot be used with machining center without synchronized tapping function.

MEGA SYNCHRO TAPPING HOLDER

TAPPING RANGE: AU13/16-AU1-1/2

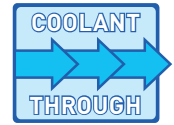

A.1
BCV/CV

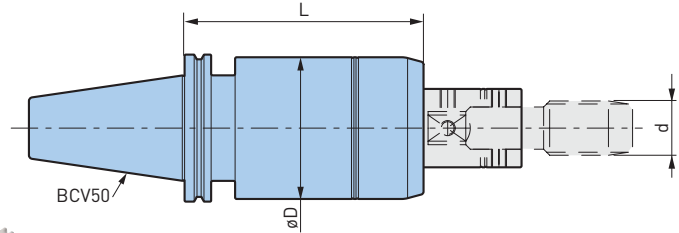

Catalog Number	Tapping Range d (Inch)	Tapping Range d (Metric)	øD	L	Weight (lbs.)
BCV50-MGT36-6.5	AU13/16-AU1-1/2 AP3/8-AP1	M20-M36	3.70	6.50	15.8

- MGT set screw is included, tap holder must be ordered separately

ACCESSORIES



CAUTION

Cannot be used with machining center without synchronized tapping function.

CKB SHANKS

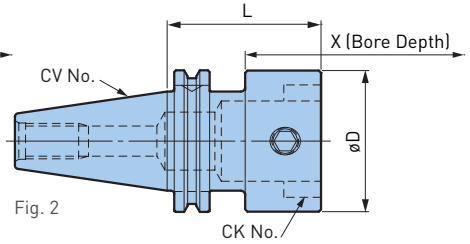
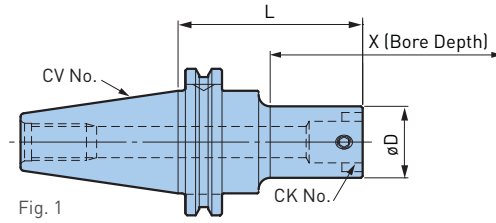
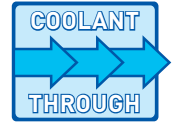

Catalog Number	Reference Number	Fig.	CK	øD	L	X	Weight (lbs.)
CV40-CKB1-48	11.326.410	1	CKB1	.750	1.870	1.570	2.2
-91	11.326.411				3.562	3.150	2.5
-CKB2-53	11.326.420	1	CKB2	.944	2.067	1.970	2.3
-85	11.326.421				3.327	3.150	2.5
-105	11.326.422				4.114	3.937	3.0
-CKB3-54	11.326.430	1	CKB3	1.220	2.126	2.165	2.5
-80	11.326.431				3.150	3.150	3.0
-130	11.326.433				5.118	5.118	3.5
-CKB4-38	11.326.440	1	CKB4	1.535	1.496	1.970	2.5
-73	11.326.441				2.874	3.150	3.0
-153	11.326.444				6.024	6.300	5.0
-CKB5-63	11.326.451	2	CKB5	1.968	2.480	3.150	3.0
-143	11.326.454				5.630	6.300	6.0
-CKB6-69	11.326.462	2	CKB6	2.500	2.716	3.937	3.0
-129	11.326.464				5.079	6.300	6.5
CV45-CKB4-92	11.326.542	1	CKB4	1.535	3.611	3.937	4.5
-CKB5-83	11.326.552	1	CKB5	1.968	3.268	3.937	5.0
-CKB6-69	11.326.562	2	CKB6	2.500	2.716	3.937	5.0
-CKB7-83	11.326.574	2	CKB7	3.543	3.268	6.300*	7.8
CV50-CKB1-48	11.326.610	1	CKB1	.750	1.870	1.570	6.2
-91	11.326.611				3.562	3.150	7.0
-CKB2-53	11.326.620	1	CKB2	.944	2.067	1.970	6.5
-105	11.326.622				4.114	3.937	7.5
-135	11.326.623				5.295	5.118	7.6
-CKB3-54	11.326.630	1	CKB3	1.220	2.126	2.165	7.0
-100	11.326.632				3.937	3.937	7.5
-130	11.326.633				5.118	5.118	7.8
-160	11.326.634				6.300	6.300	8.0
-CKB4-92	11.326.642	1	CKB4	1.535	3.611	3.937	8.0
-153	11.326.644				6.023	6.300	8.3
-193	11.326.645				7.598	7.875	8.8
-CKB5-83	11.326.652	1	CKB5	1.968	3.268	3.937	7.5
-143	11.326.654				5.630	6.300	9.2
-183	11.326.655				7.205	7.875	11.0
-243	11.326.656				9.567	10.236	12.8

Catalog Number	Reference Number	Fig.	CK	øD	L	X	Weight (lbs.)
CV50-CKB6-69	11.326.662	1	CKB6	2.500	2.716	3.937	7.6
-129	11.326.664				5.079	6.300	10.5
-169	11.326.665				6.654	7.875	13.0
-229	11.326.666				9.016	10.236	15.8
-289	11.326.667				11.378	12.598	18.5
-CKB7-83	11.326.674	2	CKB7	3.543	3.268	6.300*	9.8
-135	11.326.675				5.315	8.546*	15.7
-183	11.326.676				7.205	10.236*	21.0
CV60-CKB5-245	11.360.556	1	CKB5	1.968	9.656	10.212	28.0
-CKB6-79	11.360.562		CKB6	2.500	3.100	4.200	23.5
-130	11.360.564				5.100	6.200	26.0
-180	11.360.565				7.100	8.200	28.0
-282	11.360.567				11.100	10.200	33.0
-CKB7-135	11.360.575		CKB7	3.543	5.300	8.215	30.5
-185	11.360.576				7.300	10.215	35.5
-287	11.360.578				11.300	14.215	45.0

*For CKB7, Bore Depth applies for boring heads with length of 4.606"
 • X dimensions on the table are reference figures when EWN/EWE head is mounted

ACCESSORIES

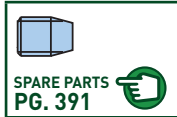

CKN SHANKS

Catalog Number	Reference Number	Fig.	CK	øD	L	X	Weight (lbs.)
CV40-CKN6-129	11.326.464N	2	CKN6	2.500	5.079	6.300	6.5
CV50-CKN6-69	11.326.662N	1	CKN6	2.500	2.716	3.937	7.6
-129	11.326.664N			2.500	5.079	6.300	10.5
-169	11.326.665N			2.500	6.654	7.875	13.0
-228	11.326.666N			2.500	9.016	10.236	15.8
-289	11.326.667N			2.500	11.378	12.598	18.5
-CKN7-135	11.326.675N	2	CKN7	3.543	5.315	8.546	15.7
-183	11.326.676N			3.543	7.205	10.236	21.0

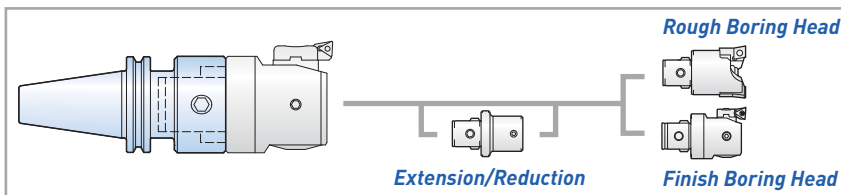

CKB SHANKS—BIG-PLUS

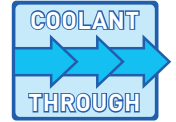
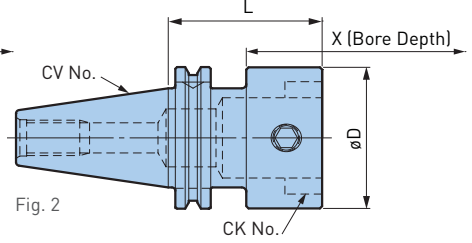
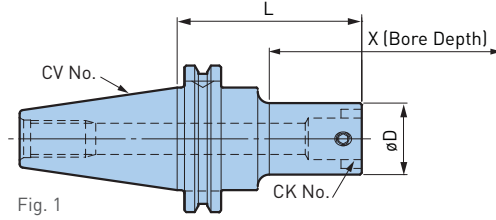
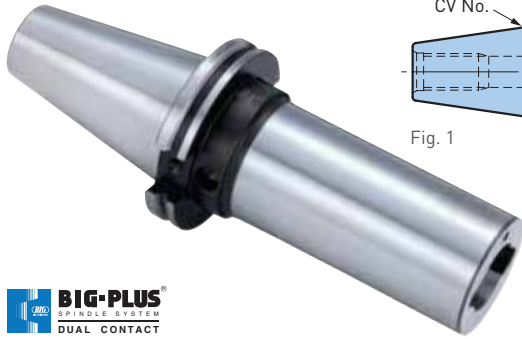

Catalog Number	Reference Number	Fig.	CK	ϕD	L	X	Weight (lbs.)
BCV40-CKB4-73	11.368.441	1	CKB4	1.535	2.874	3.150	3.0
-153	11.368.444				6.024	6.300	5.0
-CKB5-63	11.368.451	2	CKB5	1.968	2.480	3.150	3.0
-143	11.368.454				5.630	6.300	6.0
-CKB6-69	11.368.462	2	CKB6	2.500	2.716	3.937	3.0
-129	11.368.464				5.079	6.300	6.5
BCV50-CKB4-92	11.368.642	1	CKB4	1.535	3.661	3.937	8.0
-CKB4-153	11.368.644				6.023	6.300	8.3
-193	11.368.645				7.598	7.875	8.8
-CKB5-83	11.368.652	1	CKB5	1.968	3.268	3.937	7.5
-143	11.368.654				5.630	6.300	9.2
-183	11.368.655				7.205	7.875	11.0
-243	11.368.656				9.567	10.236	12.8
-CKB6-69	11.368.662	1	CKB6	2.500	2.716	3.937	7.6
-129	11.368.664				5.079	6.300	10.5
-169	11.368.665				6.654	7.875	13.0
-229	11.368.666				9.016	10.236	15.8
-289	11.368.667				11.378	12.598	18.5
-CKB7-83	11.368.674	2	CKB7	3.543	3.268	6.300*	9.8
-135	11.368.675				5.315	8.546*	15.7
-183	11.368.676				7.205	10.236*	21.0

• X dimensions on the table are reference figures when EWN/EWE head is mounted

CKN SHANKS—BIG-PLUS

Catalog Number	Reference Number	Fig.	CK	ϕD	L	X	Weight (lbs.)
BCV40-CKN6-69	11.368.462N	2	CKN6	2.500	2.716	3.937	3.0
BCV50-CKN6-69	11.368.662N	1	CKN6	2.500	2.716	3.937	7.6
-129	11.368.664N			2.500	5.079	6.300	10.5
-228	11.368.666N			2.500	9.016	10.236	15.8
-CKN7-83	11.368.674N	2	CKN7	3.543	3.268	6.300	9.8
-135	11.368.675N			3.543	5.315	8.546	15.7

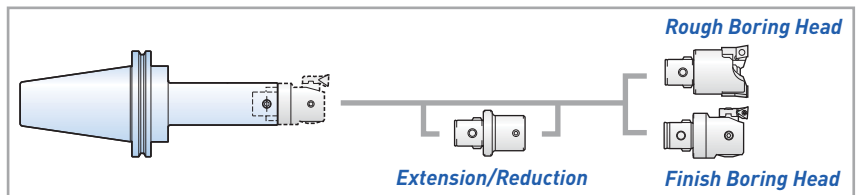

CKB SHANKS—WITH FLANGE COOLANT HOLES

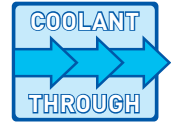

A.1
BCV/CV

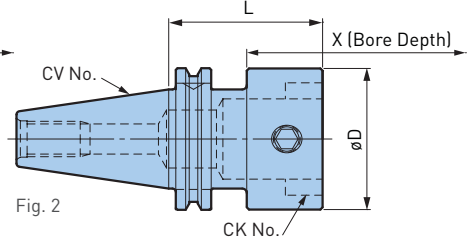
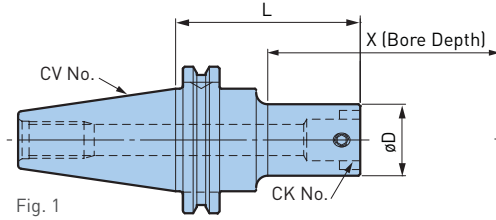

Catalog Number	Reference Number	Fig.	CK	ϕD	L	X	Weight (lbs.)
CV40-CKB4-73UDF	11.326.841	1	CKB4	1.535	2.874	3.150	3.0
-CKB5-63UDF	11.326.851	1	CKB5	1.968	2.480	3.150	3.0
-CKB6-69UDF	11.326.862	2	CKB6	2.500	2.716	3.937	3.0
CV50-CKB6-69UDF	11.326.962	1	CKB6	2.500	2.716	3.937	7.6
-CKB7-83UDF	11.326.974	2	CKB7	3.543	3.268	6.300*	9.8

- For CKB7 Bore Depth applies for boring heads with length of 4.606
- X dimensions on the table are reference figures when EWN/EWE head is mounted

ACCESSORIES

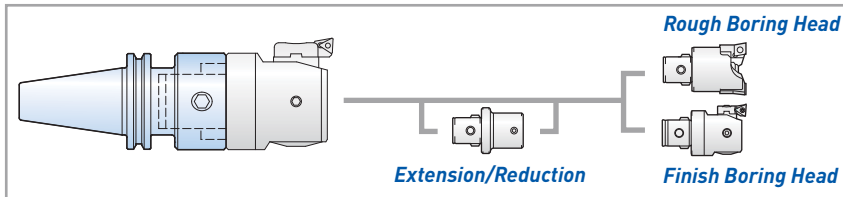

BCV/CV
A.1

BIG CAPTO SHANKS

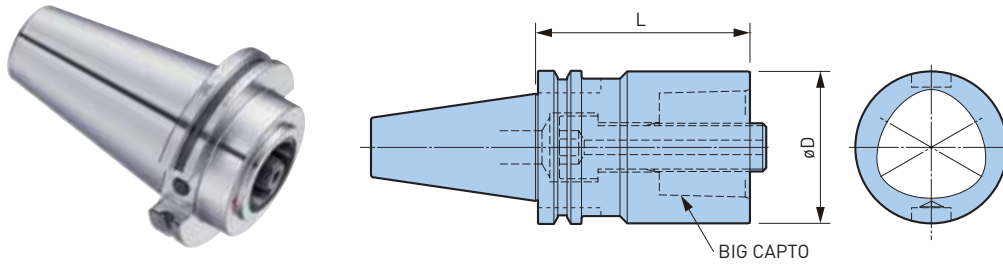

Catalog Number	BIG CAPTO	øD	L	Weight (lbs.)
BCV40Y-C5-3	C5	1.969	3.000	3.6
-C6-3.5	C6	2.480	3.500	4.2
BCV50Y-C5-1.5	C5	1.969	1.500	7.5
-C6-2	C6	2.480	2.000	7.5
-C8-3	C8	3.150	3.000	8.9

- Clamp bolt is included

CAUTION

Y Style BCV tool holders include a tight tolerance drive key for turning applications. Does not conform to older ASME B5.50 safe zone standard. Interference with tool change may occur on machines made to an older standard. Consult engineering for specific information about the intended machine.

ABS SHANKS

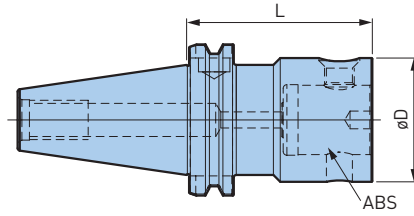

Catalog Number	ABS	øD	L	Weight (lbs.)
BCV40-ABS50-75	ABS50	1.969	2.953	2.8
-ABS63-90	ABS63	2.480	3.543	3.5
BCV50-ABS40-60	ABS40	1.575	2.362	7.0
-ABS50-60	ABS50	1.969	2.362	7.1
-ABS63-80	ABS63	2.480	3.150	7.7
-ABS80-100	ABS80	3.150	3.937	10.0
-ABS100-125	ABS100	3.937	4.921	15.0

AG90 NBS TYPE

CLAMPING RANGE: ϕ .010"-.787"

MAX
6,000
RPM

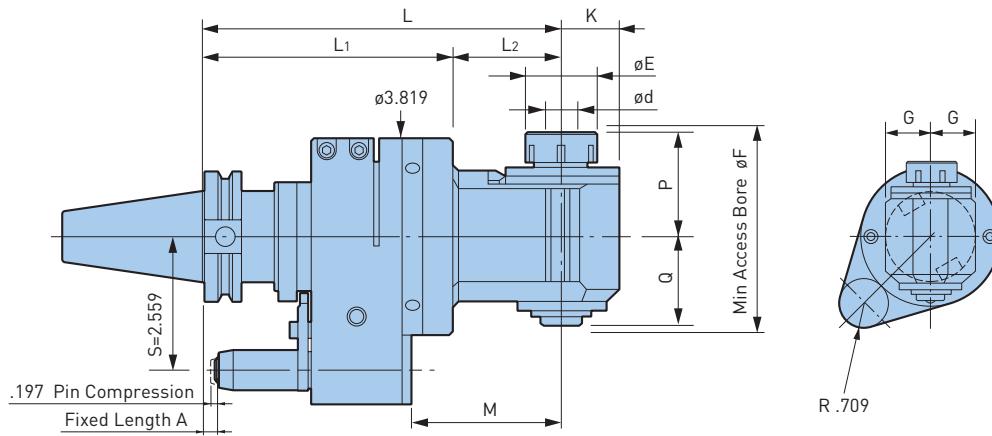

Catalog Number	ϕd	ϕE	G	K	L	L1	L2	M	P	Q	ϕF	Collet	Max RPM	Weight (lbs.)
BCV40-AG90/NBS6-180	.010-.236	.787	.827	.669	7.09	4.92	2.17	3.03	1.30	1.14	2.638	NBC6-□	6,000	11.2
-210					8.27		3.35	4.21						11.7
-240					9.45		4.53	5.39						12.1
-270					10.63		5.71	6.58						12.5
-AG90/NBS10-180	.059-.394	1.181	1.181	.984	7.09	4.92	2.17	3.03	1.77	1.69	3.583	NBC10-□	6,000	12.1
-210					8.27		3.35	4.21						13.0
-240					9.45		4.53	5.39						13.7
-AG90/NBS13-180	.098-.512	1.378	1.220	1.102	7.09	4.92	2.17	3.03	2.05	1.77	3.976	NBC13-□	6,000	12.3
-210					8.27		3.35	4.21						13.2
-240					9.45		4.53	5.39						13.9
-AG90/NBS20S-175S	.098-.787	1.811	1.378	1.299	6.89	4.80	2.09	2.84	2.56	2.44	5.197	NBC20-□	3,000	17.6

- Nut and wrench are included, collet must be ordered separately
- The angles of the locating pin to the drive key groove and direction of cutting edge are freely adjustable
- A stop block is required when mounting on machines must be order separately
- When supplied through the stop block, coolant can be ejected from the housing
- Automatic tool change may not be available depending on machine tool models
- NEW BABY ENDMILL COLLETS cannot be used

ACCESSORIES



CAUTION

A Stop Block is required. The rotation of the cutting tool is in reverse direction of the machine spindle (Speed Ratio 1:1).

AG90 NBS TYPE

CLAMPING RANGE: ϕ .010"-.787"

MAX
6,000
RPM

A.1
BCV/CV

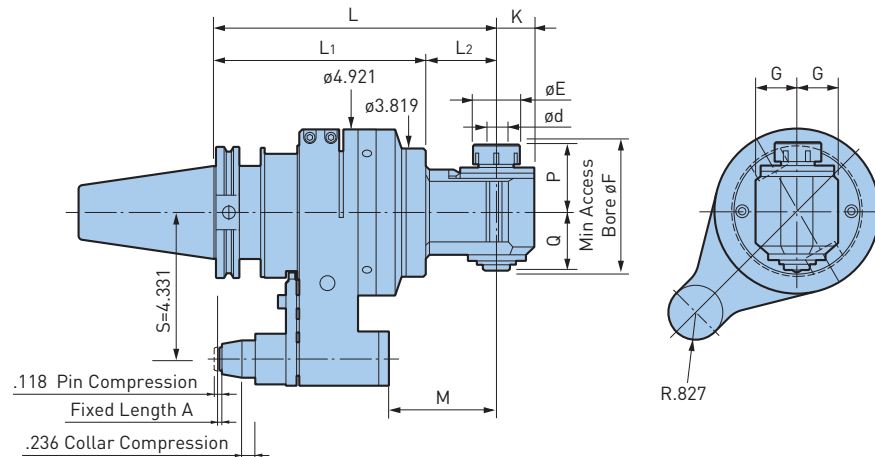

Catalog Number	ϕd	ϕE	G	K	L	L1	L2	M	P	Q	ϕF	Collet	Max RPM	Weight (lbs.)
BCV50-AG90/NBS6-215	.010-.236	.787	.827	.669	8.47	6.30	2.17	3.23	1.30	1.14	2.638	NBC6-□	6,000	27.8
-245					9.65		3.35	4.41						28.2
-275					10.83		4.53	5.59						28.7
-305					12.01		5.71	6.77						29.1
-AG90/NBS10-215	.059-.394	1.181	1.181	.984	8.47	6.30	2.17	3.23	1.77	1.69	3.583	NBC10-□	6,000	28.7
-245					9.65		3.35	4.41						29.5
-275					10.83		4.53	5.59						30.2
-AG90/NBS13-215	.098-.512	1.378	1.220	1.102	8.47	6.30	2.17	3.23	2.05	1.77	3.976	NBC13-□	6,000	28.9
-245					9.65		3.35	4.41						29.8
-275					10.83		4.53	5.59						30.4
-AG90/NBS20-230	.098-.787	1.811	1.378	1.378	9.06	6.30	2.76	3.82	2.56	2.44	5.197	NBC20-□	3,000	31.3

- Nut and wrench are included, collet must be ordered separately
- The angles of the locating pin to the drive key groove and direction of cutting edge are freely adjustable
- A stop block is required when mounting on machines must be order separately
- When supplied through the stop block, coolant can be ejected from the housing
- Automatic tool change may not be available depending on machine tool models
- NEW BABY ENDMILL COLLETS cannot be used

ACCESSORIES



CAUTION

A Stop Block is required. The rotation of the cutting tool is in reverse direction of the machine spindle [Speed Ratio 1:1].

AG90 NBS EXTRA LONG TYPE

CLAMPING RANGE: ϕ .010"-.787"

MAX
6,000
RPM

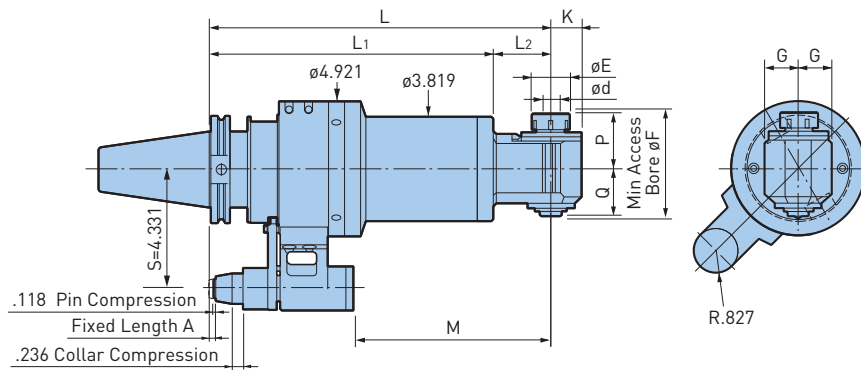

BIG-PLUS
SPINDLE SYSTEM
DUAL CONTACT

Catalog Number	ϕd	ϕE	G	K	L	L ₁	L ₂	M	P	Q	ϕF	Collet	Max RPM	Weight (lbs.)
BCV50-AG90/NBS6-315LS	.010-.236	.787	.827	.669	12.40	10.24	2.17	7.17	1.30	1.14	2.638	NBC6-□	6,000	41.7
-345LS					13.58		3.35	8.35						42.1
-375LS					14.76		4.53	9.53						42.5
-405LS					15.95		5.71	10.71						43.0
-415LS					16.34	2.17	11.10	51.4						
-445LS					17.52	3.35	12.28	51.8						
-475LS					18.70	4.53	13.47	52.2						
-505LS					19.88	5.71	14.65	52.7						
-515LS					20.28	2.17	15.04	61.1						
-545LS					21.46	3.35	16.22	61.5						
-575LS					22.64	4.53	17.40	61.9						
-605LS					23.82	5.71	18.58	62.4						

Catalog Number	ød	øE	G	K	L	L1	L2	M	P	Q	øF	Collet	Max RPM	Weight (lbs.)
BCV50-AG90/NBS10-315LS	.059-.394	1.181	1.181	.984	12.40	10.24	2.17	7.17	1.77	1.69	3.583	NBC10-□	6,000	42.5
-345LS					13.58		3.35	8.35						43.4
-375LS					14.76		4.53	9.53						44.1
-415LS					16.34	2.17	11.10	52.2						
-445LS					17.52	3.35	12.28	53.1						
-475LS					18.70	4.53	13.47	53.8						
-515LS					20.28	2.17	15.04	61.9						
-545LS					21.46	18.11	3.35	16.22						62.8
-575LS					22.64	4.53	17.40	63.5						
-AG90/NBS13-315LS					.098-.511	1.378	1.220	1.102						12.40
-345LS	13.58	3.35	8.35	43.7										
-375LS	14.76	4.53	9.53	44.3										
-415LS	16.34	2.17	11.10	52.5										
-445LS	17.52	3.35	12.28	53.4										
-475LS	18.70	4.53	13.47	54.0										
-515LS	20.28	2.17	15.04	62.2										
-545LS	21.46	18.11	3.35	16.22					63.1					
-575LS	22.64	4.53	17.40	63.7										
-AG90/NBS20-330LS	.098-.787	1.811	1.378	1.378					12.99	10.24	2.76	7.76	2.56	2.44
-430LS					16.93	14.17	2.76	11.69	54.9					
-530LS					20.87	18.11	2.76	15.63	64.6					

- Nut and wrench are included, collet must be ordered separately
- Output spindles of twin head do not rotate in forward direction simultaneously
- The angles of the locating pin to the drive key groove and direction of cutting edge are freely adjustable
- A stop block is required when mounting on machines must be order separately
- When supplied through the stop block, coolant can be ejected from the housing
- Automatic tool change may not be available depending on machine tool models
- NEW BABY ENDMILL COLLETS cannot be used

ACCESSORIES



CAUTION

A Stop Block is required. The rotation of the cutting tool is in reverse direction of the machine spindle (Speed Ratio 1:1).

AG90 COMPACT TYPE

CLAMPING RANGE: ϕ .098"-.512"

For Drilling Only—Ideal Size for Small Machining Centers

**MAX
5,000
RPM**

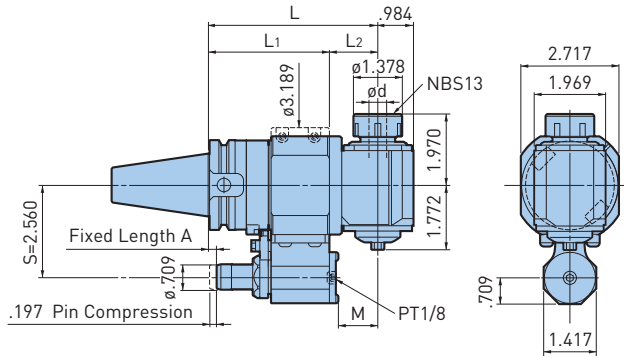

Catalog Number	ϕd	L	L1	L2	M	Collet	Max RPM	Weight (lbs.)
BCV40-AG90-13-120	.098-.512	4.72	3.39	1.34	1.10	NBS13-□	1:1	10.0

- Nut and wrench are included, collet must be ordered separately
- The angles of the locating pin to the drive key groove and direction of cutting edge are freely adjustable
- A stop block is required when mounting on machines must be order separately
- A tapped hole (PT1/8) is prepared at the bottom cover of the Locating Pin housing so that a pipe for coolant can be connected
- Automatic tool change may not be available depending on machine tool models
- NEW BABY ENDMILL COLLETS cannot be used

ACCESSORIES



CAUTION

A Stop Block is required. The rotation of the cutting tool is in reverse direction of the machine spindle (Speed Ratio 1:1). AG90 Compact Type is for drilling only.

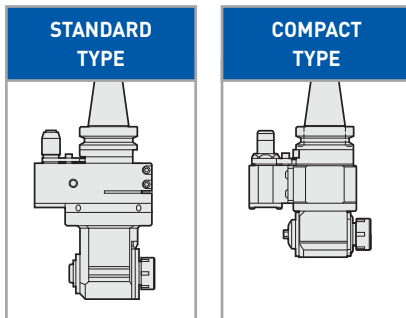

Case & Head Sizes are Substantially Reduced

- High precision New Baby Collet
- Spiral bevel gears and angular contact bearings
- Advanced non-contact sealing structure

APPLICATION EXAMPLE



Stable machining is obtained due to high rigidity and good runout.

DRILLING	
Cutter	ϕ .472" (12mm) Carbide Drill
Workpiece	1050 Steel
Cutting Speed	230 SFM
Cutting Feed	14.6 IPM
	.008 IPR
Spindle Speed	1,860 RPM

AG90 SLENDER DRIVE

CLAMPING RANGE: $\phi.118$ "-.236" For Angular Operations within a $\phi.1.181$ Inch Bore

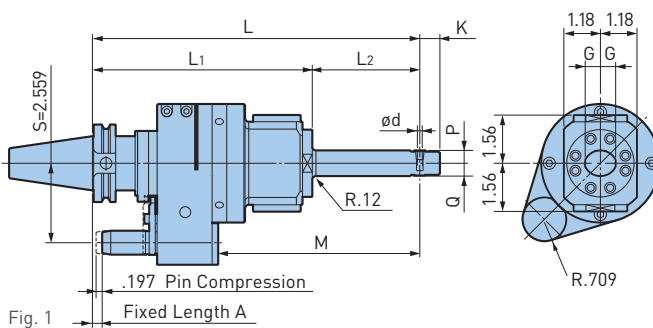
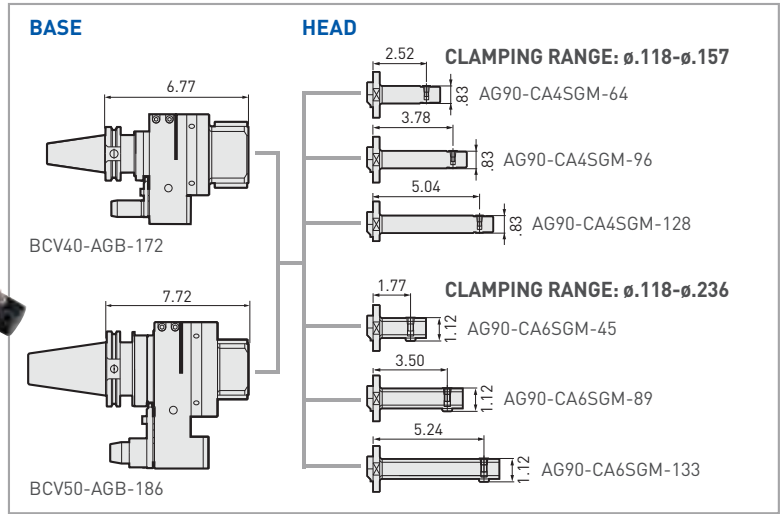

Fig. 1

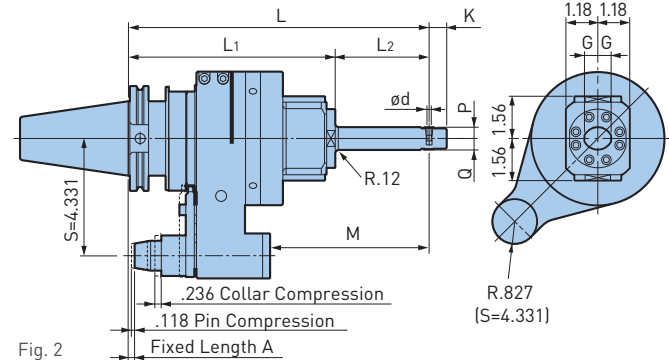

Fig. 2

Base	Head	Fig.	ϕd	G	K	L	L1	L2	M	P	Q	Speed Ratio	Weight (lbs.)
BCV40-AGB-172	AG90-CA4SGM-64	1	.118-.157	.492	.650	9.29	7.09	2.21	5.24	.41	.41	1:1.06 (Increase)	12.3
	-96					10.55		3.47	6.50				12.6
	-128					11.81		4.72	7.76				12.9
	AG90-CA6SGM-45	1	.118-.236	.591	.787	8.54	7.09	1.46	4.49	.49	.63	1:0.77 (Decrease)	12.6
	-89					10.28		3.19	6.22				13.0
-133	12.01	4.92	7.95	13.5									
BCV50-AGB-186	AG90-CA4SGM-64	2	.118-.157	.492	.650	9.84	7.64	2.21	4.61	.41	.41	1:1.06 (Increase)	26.2
	-96					11.10		3.47	5.87				26.5
	-128					12.36		4.72	7.13				26.7
	AG90-CA6SGM-45	2	.118-.236	.591	.787	9.09	7.64	1.46	3.86	.49	.63	1:0.77 (Decrease)	26.5
	-89					10.83		3.19	5.59				26.9
-133	12.56	4.92	7.32	27.3									

- Collet must be ordered separately
- The angles of the locating pin to the drive key groove and direction of cutting edge are freely adjustable
- A stop block is required when mounting on machines must be order separately

ACCESSORIES



CAUTION

A Stop Block is required. The rotation of the cutting tool is in same direction of the machine spindle.

BCV/CV
A.1

AG90 BUILD-UP TYPE

For All Kinds of Machinery Applications

MAX
3,000
RPM

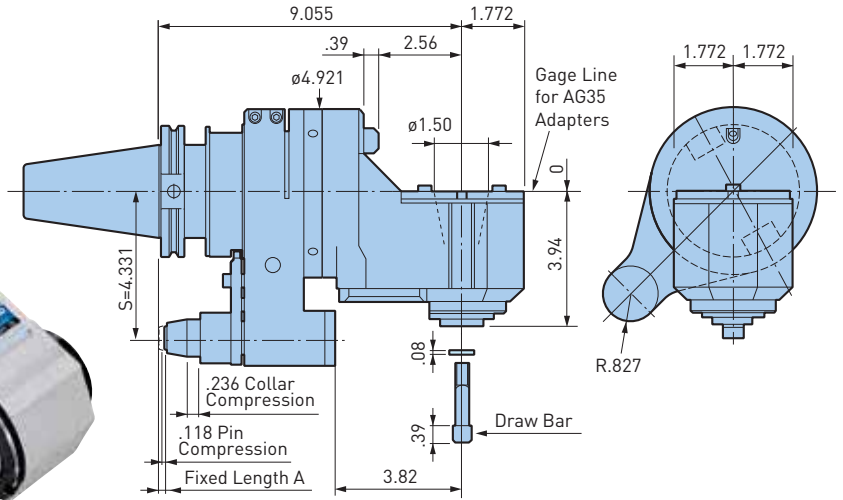

CAUTION

A Stop Block is required. The rotation of the cutting tool is in same direction of the machine spindle.

Catalog Number	Weight (lbs.)
BCV50-AG90/AGH35-230	33.1

- The angles of the locating pin to the drive key groove and direction of cutting edge are freely adjustable
- A stop block is required when mounting on machines must be order separately
- When supplied through the stop block, coolant can be ejected from the housing
- Automatic tool change may not be available depending on machine tool models

For Application Where Increased Rigidity is Required

MAX
3,000
RPM

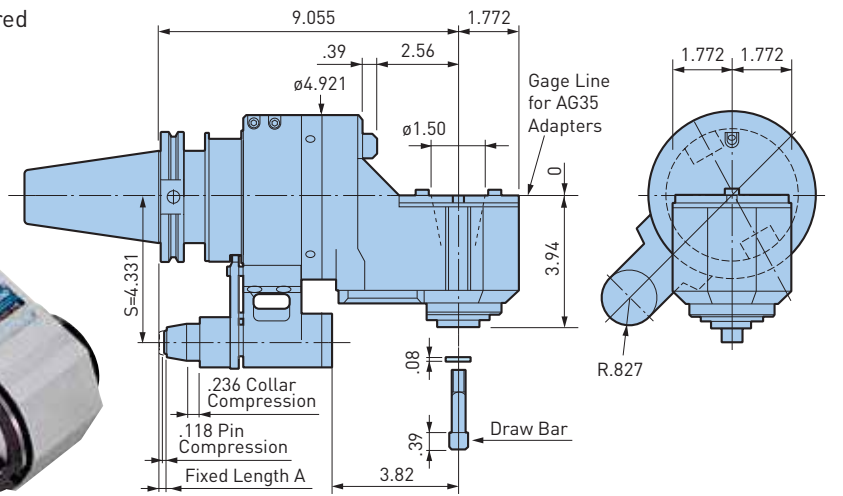

CAUTION

A Stop Block is required. The rotation of the cutting tool is in same direction of the machine spindle.

Catalog Number	Weight (lbs.)
BCV50-AG90/AGH35-230S	35.9

- The angles of the locating pin to the drive key groove and direction of cutting edge are freely adjustable
- A stop block is required when mounting on machines must be order separately
- When supplied through the stop block, coolant can be ejected from the housing
- Automatic tool change may not be available depending on machine tool models

ACCESSORIES



AG90 HMC TYPE

For Heavy Duty End Milling

**MAX
3,000
RPM**

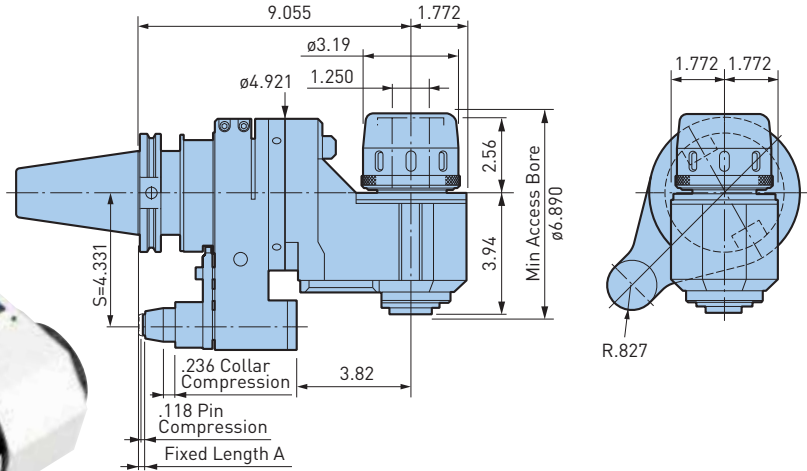

CAUTION ⚠

A Stop Block is required. The rotation of the cutting tool is in same direction of the machine spindle.

- Wrench is included
- The angles of the locating pin to the drive key groove and direction of cutting edge are freely adjustable
- A stop block is required when mounting on machines must be order separately
- When supplied through the stop block, coolant can be ejected from the housing
- Automatic tool change may not be available depending on machine tool models



Catalog Number	Weight (lbs.)
BCV50-AG90/HMC1.250-230	37.0

For Applications Where Increased Rigidity is Required

**MAX
3,000
RPM**

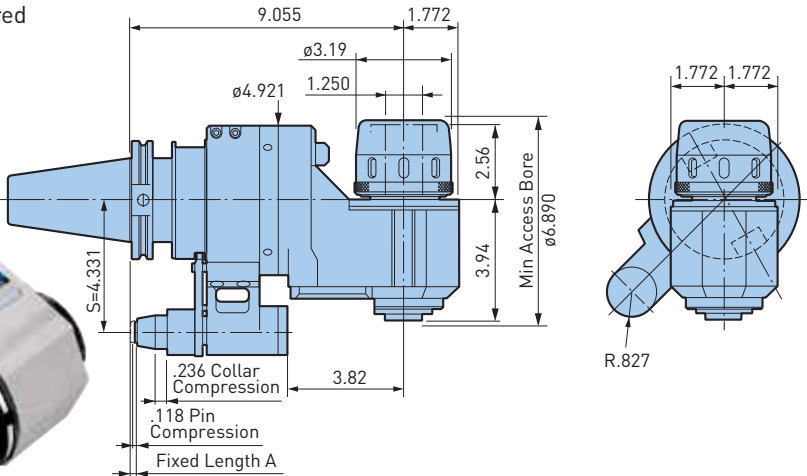

CAUTION ⚠

A Stop Block is required. The rotation of the cutting tool is in same direction of the machine spindle.

- Wrench is included
- The angles of the locating pin to the drive key groove and direction of cutting edge are freely adjustable
- A stop block is required when mounting on machines must be order separately
- When supplied through the stop block, coolant can be ejected from the housing
- Automatic tool change may not be available depending on machine tool models



Catalog Number	Weight (lbs.)
BCV50-AG90/HMC1.250-230S	39.9

ACCESSORIES



AGU UNIVERSAL TYPE

CLAMPING RANGE: ϕ .098"-.787" For Angular Operations

**MAX
6,000
RPM**

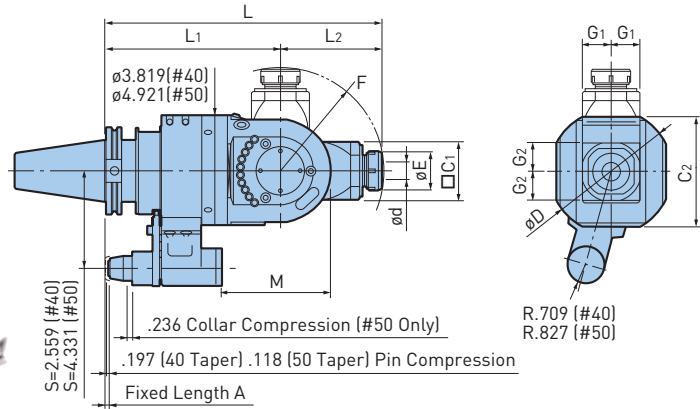

Catalog Number	ϕd	ϕE	ϕD	$\square C1$	$C2$	$G1$	$G2$	L	$L1$	$L2$	M	F	Collet	Max RPM	Weight (lbs.)
BCV40-AGU/NBS13-280	.098-.512	1.378	4.53	2.00	3.82	1.024	1.014	11.02	7.09	3.94	4.88	4.02	NBC13- \square	6,000	21.4
BCV50-AGU/NBS20-315	.098-.787	1.811	5.51	2.56	4.92	1.299	1.280	12.40	7.87	4.53	4.92	4.65	NBC20- \square	4,000	44.1

- Nut and wrench are included, collet must be ordered separately
- The angles of the locating pin to the drive key groove and direction of cutting edge are freely adjustable
- A stop block is required when mounting on machines must be order separately
- Automatic tool change may not be available depending on machine tool models

ACCESSORIES



CAUTION

A Stop Block is required. The rotation of the cutting tool is in reverse direction of the machine spindle [Speed Ratio 1:1].



Exclusive Clamping Bolts and Nuts

Specially selected materials and special design for clamping the head guarantees rigidity even for end milling applications.

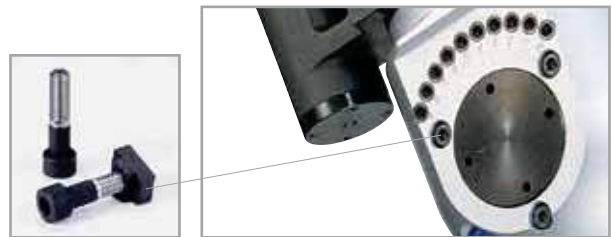

APPLICATION EXAMPLE

Adjustable AGU Universal Series expands ANGLE HEAD capabilities to accomplish various angular machining applications.

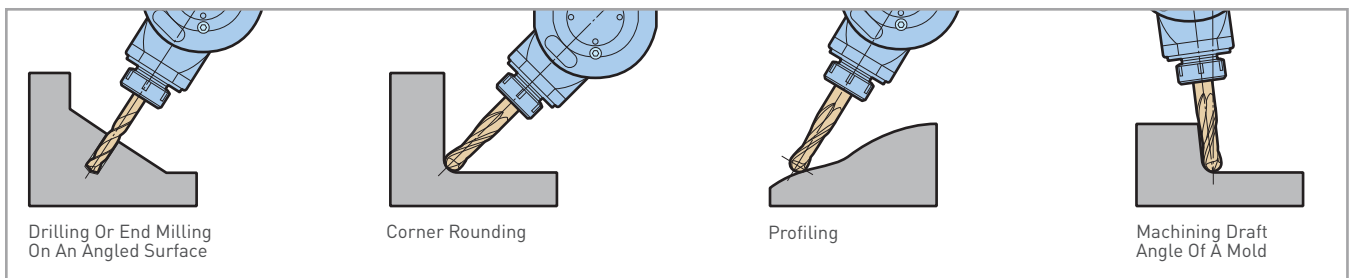

AGU30 TYPE

CLAMPING RANGE: ϕ .098"-.787" For Angular Operations

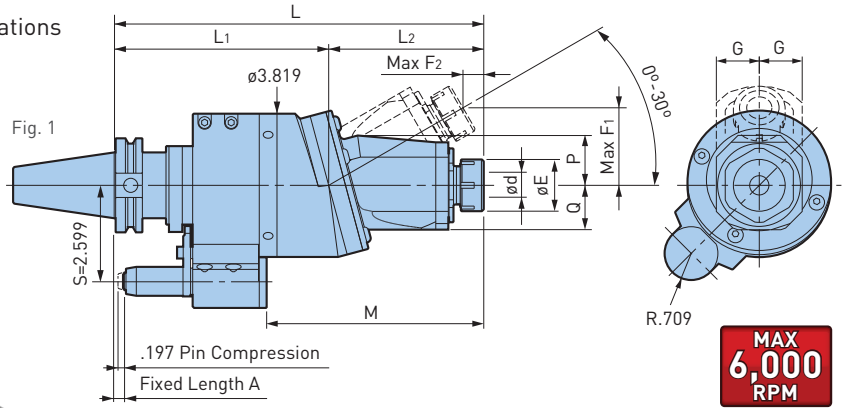

Angle Adjustment by Aligning Divisions

Spindle angle is easily adjustable from 0° to 30° using the scale indication on the body.

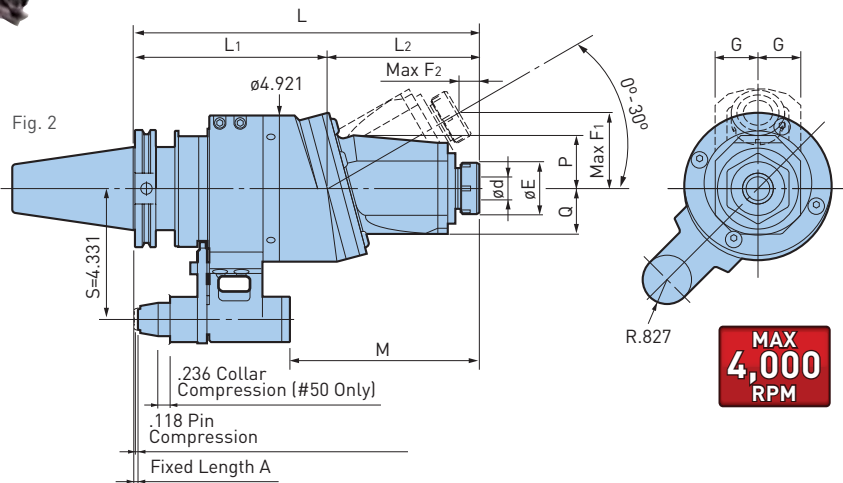
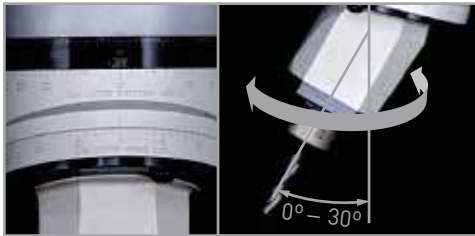

Catalog Number	Fig.	ϕ d	ϕ E	G	L	L1	L2	M	P	Q	F1	F2	Collet	Max RPM	Weight (lbs.)
BCV40-AGU30/NBS13-250	1	.098-.512	1.378	1.142	9.84	5.71	4.13	5.79	1.34	1.18	2.07	.55	NBC13-□	1:1	15.3
BCV50-AGU30/NBS20-295	2	.098-.787	1.811	1.437	11.61	6.50	5.12	6.38	1.77	1.54	2.56	.67	NBC20-□	1:1	35.8

- Nut and wrench are included, collet must be ordered separately
- The angles of the locating pin to the drive key groove and direction of cutting edge are freely adjustable
- A stop block is required when mounting on machines must be order separately
- Automatic tool change may not be available depending on machine tool models
- When supplied through the stop block, coolant can be ejected from the housing

ACCESSORIES



CAUTION

A Stop Block is required. The rotation of the cutting tool is in reverse direction of the machine spindle (Speed Ratio 1:1).

SETTING DISC (INCLUDED)

For the precise adjustment of spindle angle or direction.

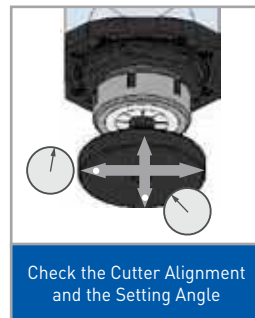

AIR POWER SPINDLE—RBX5 & RBX7 For High Speed Micro Machining with Automatic Tool Change

MAX
80,000
RPM

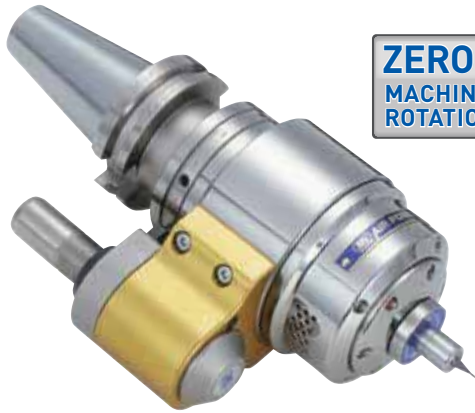

ZERO
MACHINE SPINDLE
ROTATION

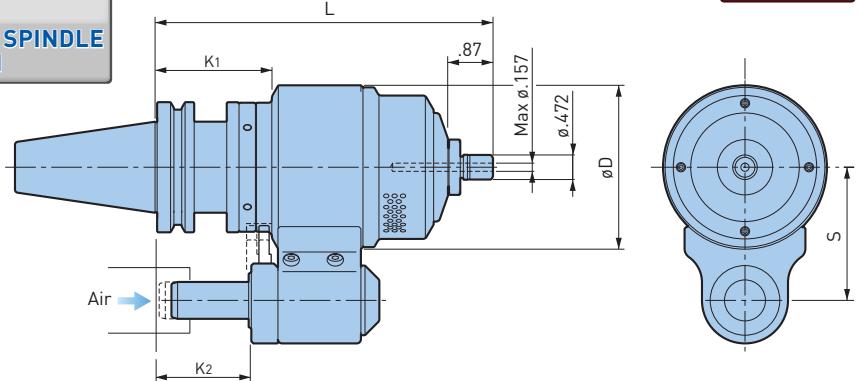

Catalog Number	Practical Spindle Speed (RPM)	Cutting Diameter	L	øD	K1	K2	S	Weight (lbs.)
BCV40-RBX7-4S-165-65	60,000-80,000	ø.039 or smaller	6.50	3.150	2.24	1.85	2.559	8.8
-RBX5-4S-165-65	40,000-50,000	ø.059 or smaller		3.780				11.0
BCV50-RBX7-4S-170-80	60,000-80,000	ø.039 or smaller	6.69	3.937	2.44	2.05	3.150	19.1
-RBX5-4S-170-80	40,000-50,000	ø.059 or smaller		3.937				21.3

- Nut and wrench are included, collet must be ordered separately
- XF1-NPT (Air Unit) must be ordered separately

CAUTION

Compressed air to drive the AIR POWER SPINDLE must be clean. Coolant should not be supplied through the spindle on the machine that uses the AIR POWER SPINDLE.

For High Speed Micro Machining with Compressed Air Through the Machine Spindle

MAX
80,000
RPM

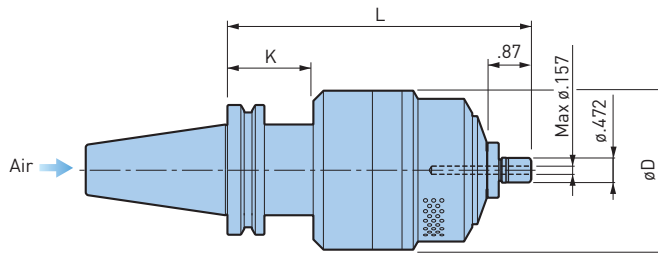
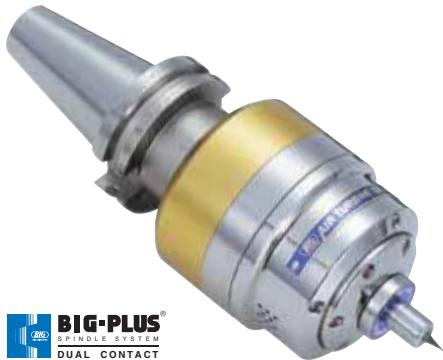

Catalog Number	Practical Spindle Speed (RPM)	Cutting Diameter	L	øD	K1	Weight (lbs.)
BCV40H-RBX7C-4S-150	60,000-80,000	ø.039 or smaller	5.91	3.150	1.69	6.8
-RBX5C-4S-150	40,000-50,000	ø.059 or smaller		3.780		9.0
BCV50-RBX7C-4S-145	60,000-80,000	ø.039 or smaller	5.71	3.150	1.50	12.8
-RBX5C-4S-145	40,000-50,000	ø.059 or smaller		3.780		15.0

- Nut and wrench are included, collet must be ordered separately
- XF1-NPT (Air Unit) is required must be ordered separately

CAUTION

Compressed air to drive the AIR POWER SPINDLE must be clean. Coolant should not be supplied through the spindle on the machine that uses the AIR POWER SPINDLE.

ACCESSORIES



AIR POWER SPINDLE—RBX12 For High Speed Micro Machining with Small Cutter

**MAX
120,000
RPM**

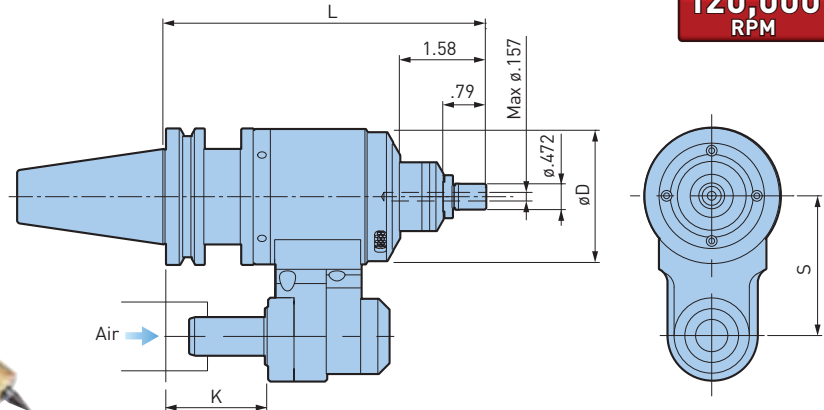
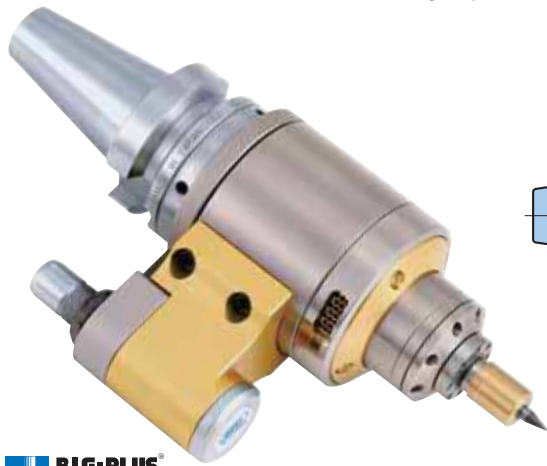

Catalog Number	Operating Spindle Speed (RPM)	Cutting Tool Diameter	L	øD	K	S	Nut	Collet	Weight (lbs.)
BCV40-RBX12-4S-150-65	100,000-120,000	ø.024 or smaller	5.91	2.480	1.23	2.559	MGN4S-HG	NBC4S-□	6.6

- Nut and wrench are included, collet must be ordered separately
- XF1-NPT (Air Unit) must be ordered separately

CAUTION

Compressed air to drive the AIR POWER SPINDLE must be clean. Coolant should not be supplied through the spindle on the machine that uses the AIR POWER SPINDLE.

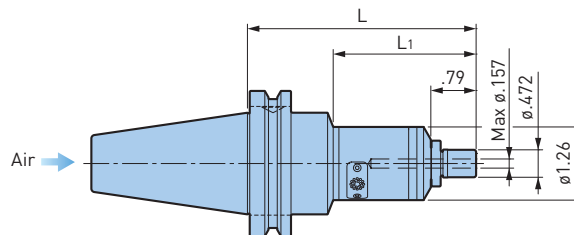
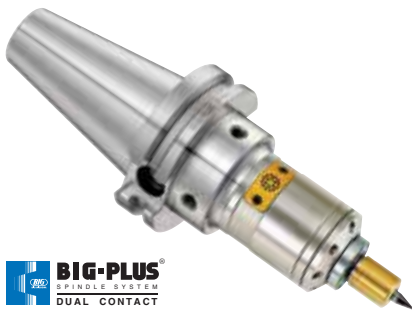

**MAX
120,000
RPM**



Catalog Number	Operating Spindle Speed (RPM)	Cutting Tool Diameter	L	L1	Nut	Collet	Weight (lbs.)
BCV40-RBX12C-4S-100	100,000-120,000	ø.024 or Smaller	3.94	2.56	MGN4S-HG	NBC4S-□	2.9

- Nut and wrench are included, collet must be ordered separately
- XF1-NPT (Air Unit) is required must be ordered separately

CAUTION

Compressed air to drive the AIR POWER SPINDLE must be clean. Coolant should not be supplied through the spindle on the machine that uses the AIR POWER SPINDLE.

ACCESSORIES



APPLICATION EXAMPLE

PREHARDENED STEEL NAK55 SHOULDER CUTTING		
RBX12	Cutter	ø.6mm Carbide End Mill (ø.024")
	Spindle Speed	120,000 RPM ⇄ 116,000 RPM
	Feed	520 mm/min [20.5 IPM]
	D.O.C.	Ad .035" Rd .001"

PREHARDENED STEEL NAK55 GROOVING		
RBX12	Cutter	ø.6mm Carbide End Mill (ø.024")
	Spindle Speed	120,000 RPM ⇄ 116,000 RPM
	Feed	260 mm/min [10.2 IPM]
	D.O.C.	Ad .002"

HIGH SPINDLE

CLAMPING RANGE: $\phi.059$ "-.630" For Higher Spindle Speeds

**MAX
20,000
RPM**

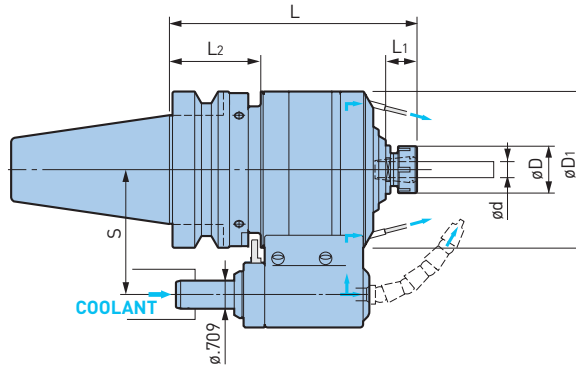
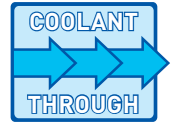

Catalog Number	ϕd	ϕD	$\phi D1$	L	L1	L2	S	Collet	Speed Ratio	Max RPM	Weight (lbs.)
BCV40-GTG5-10-155-65	.059-.394	1.181	3.150	6.10	.79	2.28	2.559	NBC10	4.67	20,000	11.0
BCV50-GTG6-10-163-80	.059-.394	1.181	3.937	6.42	.79	2.48	3.150	NBC10	5.67	20,000	19.8
-GTG4-16-182-80	.098-.630	1.654	4.331	7.17	1.00	2.48	3.150	NBC16	3.80	15,000	23.8

- NEW BABY COLLET, nut and 2 tightening wrenches are included
- The allowable torque is a calculated value of the drive system, and not the actual torque in cutting
- The maximum diameter when using an endmill is $\phi 8$ mm (GTG5, GTG6) and $\phi 12$ (GTG4)
- A Stop Block is required when mounting on machines
- For continuous rotation of over 30 minutes, the spindle speed should be set within 80% of the maximum speed

CAUTION

A Stop Block is required.

ACCESSORIES



APPLICATION EXAMPLE

	GTG5	GTG6	GTG6	GTG4
Cutter	Solid carbide end mill $\phi.315$ " / 2 flutes	Solid carbide end mill $\phi.236$ " / 2 flutes	Solid carbide drill $\phi.079$ "	Solid carbide end mill $\phi.630$ "
Workpiece	Duralumin [A-2017]	1055	Duralumin [A-2017]	Duralumin [A-2017]
Spindle Speed	20,000 RPM	16,000 RPM	20,000 RPM	15,000 RPM
Cutting Feed	118.1 IPM	137.8 IPM	78.7 IPM	39.4 IPM
Results	High metal removal rate 5.5 cu.in./min.	High metal removal rate 137.8 IPM	Extended tool life 1,200 holes by 1 drill	Surface roughness RMS max. .00008"

- Results will vary depending on workpiece, cutting tool, machine model and other conditions
- The rigidity and concentricity are often affected by the projection length of a cutting tool, it is recommended to keep the projection as short as possible



Hi-JET HOLDER—NBS TYPE

CLAMPING RANGE: ϕ .118"-.787" For Small Diameter Drills, Gun Drills & End Mills

MAX
10,000
RPM

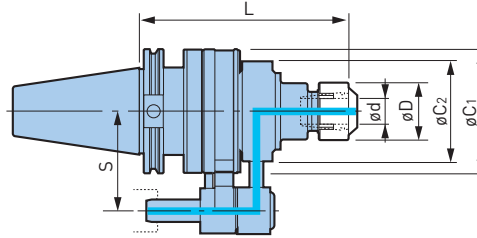
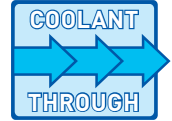

Catalog Number	ϕd	ϕD	L	ϕC_1	ϕC_2	S	Max RPM	Merit Set (2 pcs. of Merit Ring) (2 pcs. of Merit Plate)	Perfect Seal	Weight (lbs.)
CV40-ONBS13N-165	.118-.512	1.378	6.61	3.213	2.87	2.559	10,000	MES-40	BPS13	8.8
-ONBS20N-165	.118-.787	1.811			3.15		8,000	MES-50	BPS20	9.5
CV50-ONBS13N-165	.118-.512	1.378	6.61	3.921	3.15	3.150	8,000	MES-50	BPS13	16.1
-ONBS20N-165	.118-.787	1.811			3.15		8,000	MES-50	BPS20	16.5

- Collet, adjusting screw and wrench must be ordered separately
- Max coolant pressure is 284 PSI
- Clamping nut is sold separately, please order Baby Perfect Seal (BPS) for your application

CAUTION
A Stop Block is required.

ACCESSORIES



Hi-JET HOLDER—CKB TYPE

MAX
5,000
RPM

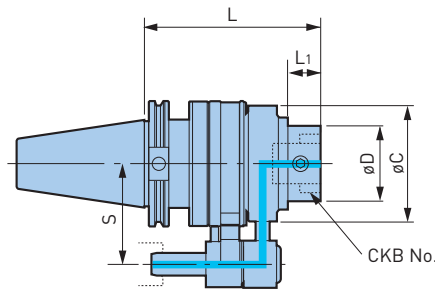
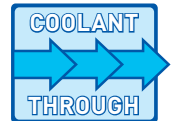

Catalog Number	CK	ϕD	L	L1	ϕC	S	Max RPM	Merit Set (2 pcs. of Merit Ring) (2 pcs. of Merit Plate)	Weight (lbs.)
CV40-OCKB6N-144	CKB6	2.520	5.67	1.102	3.92	2.559	6,000	MES-65	13.4
CV50-OCKB6N-142	CKB6	2.520	5.59	1.063	3.92	3.150	6,000	MES-65	15.9
-OCKB7N-165	CKB7	3.543	6.50	1.358	5.10	3.150	4,000	MES-90	27.0

- Max coolant pressure is 284 PSI

CAUTION
A Stop Block is required.

ACCESSORIES



Hi-JET HOLDER—TG TYPE

CLAMPING RANGE: ϕ .093"-1.000" For TG100 Single Angle Style Collets

MAX
8,000
RPM

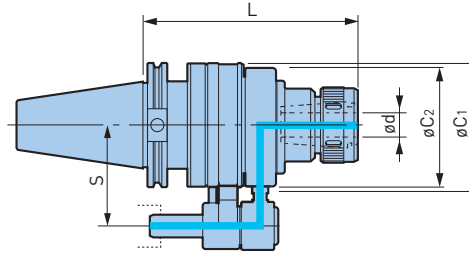
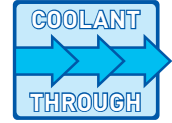

Catalog Number	Collet Series	ϕd	L	$\phi C1$	$\phi C2$	S	Max RPM	Merit Set (2 pcs. of Merit Ring) (2 pcs. of Merit Plate)	Weight (lbs.)
CV40-OHC1.000N-175	TG100	.093-1.000	6.89	3.213	3.15	2.559	8,000	MES-50	11.1
CV50-OHC1.000N-172	TG100	.093-1.000	6.77	3.921	3.86	3.150	6,000	MES-65	16.5

- Max coolant pressure is 284 PSI
- Nut included, collets not available from BIG KAISER

ACCESSORIES



CAUTION

A Stop Block is required.

Hi-JET HOLDER—OSL TYPE

CLAMPING RANGE: ϕ .750"-2.000" For Straight Shanks with Flat

MAX
8,000
RPM

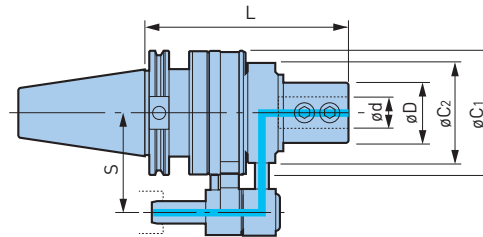
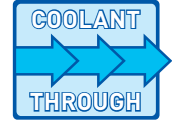

Catalog Number	Collet Series	ϕd	L	$\phi C1$	$\phi C2$	S	Max RPM	Merit Set (2 pcs. of Merit Ring) (2 pcs. of Merit Plate)	Weight (lbs.)
CV40-OSL1.000N-165	1.000	1.890	6.50	3.213	3.15	2.559	8,000	MES-50	9.7
-OSL1.250N-160	1.250	2.283	6.30	3.921	3.86		6,000	MES-65	12.6
CV50-OSL.750N-150	.750	1.890	5.91	3.921	3.15	3.150	8,000	MES-50	16.3
-OSL1.000N-165	1.000		6.50				6.50	3.86	6,000
-OSL1.250N-165	1.250	2.283	6.50	3.921	3.86	3.150	6,000	MES-65	17.4
-OSL1.500N-165	1.500	2.500	6.50	3.921	3.86	3.150	6,000	MES-65	17.6
-OSL2.000N-180	2.000	3.307	7.09	5.079	4.76	3.150	4,000	MES-90	26.2

- Max coolant pressure is 284 PSI

ACCESSORIES



CAUTION

A Stop Block is required.

Before Ordering

Be sure to check the dimensions of the required pullstud bolt by referring to the specification sheet of the machine tool. In the case of machines with coolant-through spindle capability, provide us a copy of the pullstud bolt drawing, as the sealing method may vary even among machines with the same model number.

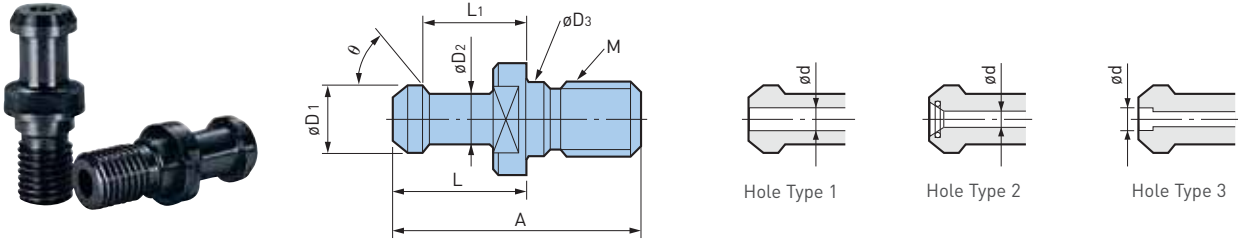

CAT40

Catalog Number	ϕD_1	ϕD_2	ϕD_3	A	L	L_1	θ	M	Hole Type	ϕd	Standard or Machine Make
P40T-1CMGHA	.591	.394	—	2.126	1.266	.990	45°	5/8"-11	1	.118	MAS -1 CAT with Hole
P40T-1C1MGH2			.641	2.250					2		Toyoda
P40T-1C1MGH			—	2.250					—		Okuma
P40T-2CH	.591	.394	—	2.126	1.266	.990	60°		1	.118	MAS-2 CAT with Hole
PVD40CMGH1	.748	.551	.641	2.008	1.024	.787	75°		1	.276	KITAMURA
40PCMGH	.748	.551	.641	2.126	1.029	.793	75°		1	.276	JIS CAT with Hole
PMQ40CMG	.748	.551	—	1.887	1.029	.793	75°		2	.276	MORI SEIKI
POM40CFMG	.591	.394		2.244	1.266	.990	90°		None	—	MORI SEIKI
PYN40CMG	.740	.490	.641	1.500	.640	.440	45°		1	.276	MAZAK
PMK40CMG	.748	.551	—	1.882	1.024	.787	75°		1	.276	MATSUURA

- Machine tool builders have used many various shapes and sizes of retention knobs
- The use of the incorrect knob may result in injury or property damage for your machining center

CAT50

Catalog Number	ϕD_1	ϕD_2	ϕD_3	A	L	L_1	θ	M	Hole Type	ϕd	Standard or Machine Make	
P50T-1CH	.906	.669	—	3.346	1.771	1.377	45°	1"-8	1	.315	MAS-1 CAT with Hole	
P50T-1CH4				3.346	1.771	1.377			2	.236	TOYODA	
P50T-2CH	.906	.669	—	3.346	1.780	1.386	60°		1	.315	MAS-2 CAT with Hole	
P50T-2CH2				3.071	1.771	1.377			1	.158	SNK	
P50T-2CH11				3.346	1.771	1.377			2	.237	OKUMA HOWA	
PVD50CH2	1.102	.826	1.031	2.919	1.344	.990	75°		1	.453	KITAMURA	
POM50CH1	.906	.669	—	3.346	1.780	1.386	90°		1"-8	2	.315	MORI SEIKI
POM50CF										None	—	MORI SEIKI
PYN50C5	1.140	.820	1.031	2.303	1.000	.700	45°		3	.394	MAZAK	
PMK50CH	1.102	.827	—	2.598	1.347	.988	75°		1	.394	MATSUURA	

- Machine tool builders have used many various shapes and sizes of retention knobs
- The use of the incorrect knob may result in injury or property damage for your machining center



MEGA PULLSTUD BOLT

MG in the model numbers stand for MEGA PULLSTUD BOLT. Tensile strength is improved by utilizing tool steel. Especially recommended for BIG-PLUS dual contact applications.

DYNA TEST

Helps identify potential problems, and can reduce downtime and costly repairs of the machine tool spindle.

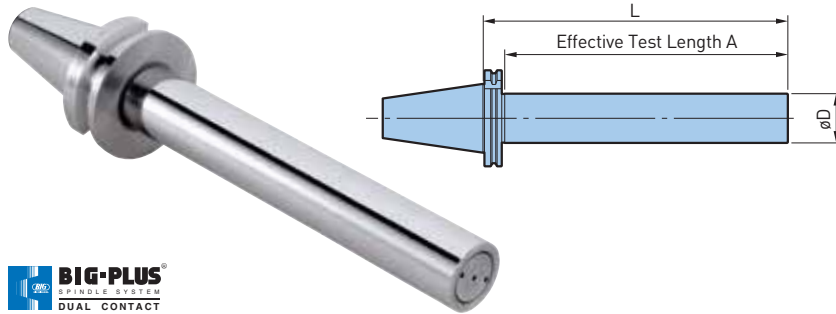

Catalog Number	L	A	øD
BCV40-2.000-L13.5SD	13.500	12.500	2.000
BCV50-2.000-L13.5SD	13.500	12.500	2.000

ATC ALIGNMENT TOOL

For re-aligning the center between the machine tool spindle and ATC gripper. It can also be used for re-aligning the ATC gripper and tool magazine pots. More detailed information on page 608.

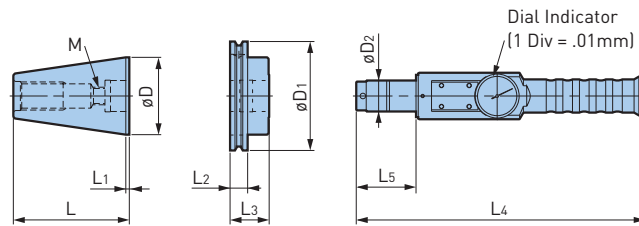

- Machine tool builders have used many various shapes and sizes of retention knobs
- The use of the incorrect knob may result in injury or property damage for your machining center

Catalog Number	øD	øD1	øD2	L	L1	L2	L3	L4	L5	M
CV40-ATC20	1.750	2.500	.787	2.812	.125	.625	.958	9.882	1.732	1/2"-13
CV50-ATC28	2.750	3.875	1.102	4.125	.125	.625	1.391	10.276	2.126	5/8"-11

BIG-PLUS CLEANER

Blowing air cleans the BIG-PLUS machine spindle face of all debris.

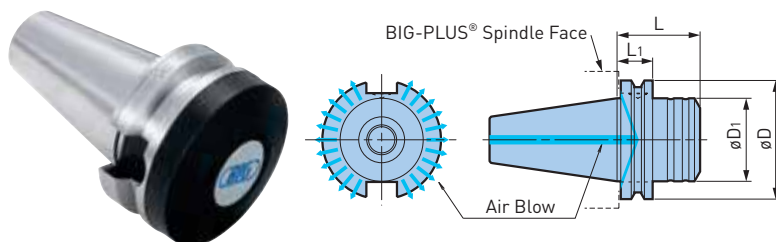

Catalog Number	øD	øD1	L	L1
SCV40-ASC-1.75T	2.480	1.750	1.750	.750
SCV50-ASC-2.5T	3.875	2.750	2.500	.750

- When the cleaner is clamped into a BIG-PLUS machine spindle, faces have 1mm (.039") clearance

BCV/CV
A.1

BLANK BAR



Catalog Number	øD	L
BCV40-BB2.500-8	2.50	8.00
-BB4.000-6	4.00	6.00
BCV50-BB4.000-8	4.00	8.00
-BB6.000-8	6.00	

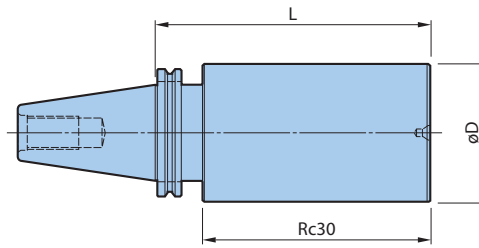

- Do not heat treat after machining



DUAL CONTACT BIG-PLUS

BBT/BT SHANK

BBT/BT
A.2



A.2



COLLET CHUCKS	108-117
MEGA MICRO CHUCK	108-109
MEGA NEW BABY CHUCK	110-113
MEGA ER GRIP	114-115
MEGA E CHUCK	116-117
MILLING CHUCKS	118-123
MEGA DOUBLE POWER CHUCK	118-119
MEGA PERFECT GRIP	120-121
NEW Hi-POWER MILLING CHUCK	122-123
HYDRAULIC CHUCKS	124-131
BASIC ARBORS	132-139
SHRINK FIT HOLDER	132-133
END MILL HOLDER	134
SIDE CUTTER ARBOR	135
MORSE TAPER HOLDER	136-137
SHELL/FACE MILL HOLDER	138
SMART DAMPER MILLING	139
TAP HOLDERS	140-141
MEGA SYNCHRO TAPPING HOLDER	140-141
MODULAR HOLDERS	142-147
CKB SHANK	142-145
BIG CAPTO SHANK	146
ABS SHANK	147
ANGLE HEADS	148-157
AG90	148-155
AGU	156-157
SPINDLE SPEEDERS	158-161
AIR POWER SPINDLE	158-159
HIGH SPINDLE	160-161
COOLANT INDUCERS	162-163
Hi-JET HOLDER	162-163
ACCESSORIES	164-165
PULLSTUD BOLTS	164
PULLSTUD WRENCHES	165
DYNA TEST	166
ATC ALIGNMENT TOOL	167
BIG-PLUS CLEANER	167

MEGA MICRO CHUCK—TYPE T

CLAMPING RANGE: ϕ .018"-.317" (ϕ .45-8.05mm) For Micro Drill & End Mill Applications

HIGHER RIGIDITY

MAX 40,000 RPM

BBT/BT A.2

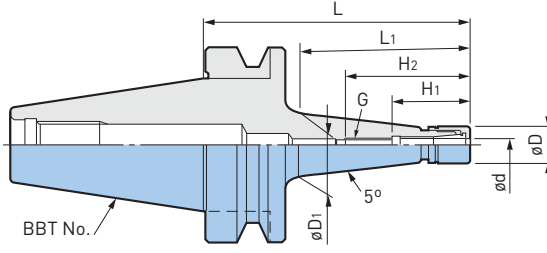

Catalog Number	ϕd	ϕD	D1	L	L1	H1	H2	G	Collet	Nut	Wrench	Max RPM	Weight (lbs.)
BBT30-MEGA3S-45T	.018-.128	.394	.45	1.77	.79	.87	1.50	M4 P0.70	NBC3S-□	MGN3S	MGR10	40,000	.8
-75T			.62	2.95	1.89							40,000	.9
-90T			.72	3.54	2.48							35,000	1.0
-105T			.83	4.13	3.07							30,000	1.1
-MEGA4S-60T	.018-.159	.472	.58	2.36	1.30	1.04	1.85	M5 P0.80	NBC4S-□	MGN4S	MGR12	40,000	.9
-75T			.69	2.95	1.89							40,000	1.0
-90T			.79	3.54	2.48							35,000	1.0
-105T			.89	4.13	1.89							30,000	1.1
-120T			1.00	4.72	3.66							25,000	1.2
-MEGA6S-60T	.018-.238	.551	.64	2.36	1.30	1.12	1.93	M7 P0.75	NBC6S-□	MGN6S	MGR14	40,000	.9
-75T			.74	2.95	1.89							40,000	1.0
-90T			.85	3.54	2.48							35,000	1.0
-105T			.95	4.13	3.07							30,000	1.2
-120T			1.06	4.72	3.66							25,000	1.3
-MEGA8S-75T	.116-.317	.709	.89	2.95	1.89	1.22	1.99	M9 P0.75	NBC8S-□	MGN8S	MGR18	40,000	1.1
-105T			1.10	4.13	3.07							30,000	1.3
BBT40-MEGA3S-60T	.018-.128	.394	.48	2.36	1.10	.87	1.50	M4 P0.70	NBC3S-□	MGN3S	MGR10	35,000	2.2
-90T			.69	3.54	2.28							28,000	2.3
-120T			.89	4.72	3.46							22,000	2.5
-MEGA4S-60T	.018-.159	.472	.55	2.36	1.10	1.04	1.85	M5 P0.80	NBC4S-□	MGN4S	MGR12	35,000	2.2
-75T			.65	2.95	1.69							32,000	2.3
-90T			.75	3.54	2.28							28,000	2.3
-105T			.86	4.13	2.87							25,000	2.4
-120T			.96	4.72	3.46							22,000	2.5
-135T			1.06	5.31	4.06							20,000	2.7
-MEGA6S-60T	.018-.238	.551	.61	2.36	1.10	1.12	1.93	M7 P0.75	NBC6S-□	MGN6S	MGR14	35,000	2.2
-75T			.71	2.95	1.69							32,000	2.3
-90T			.81	3.54	2.28							28,000	2.3
-105T			.92	4.13	2.87							25,000	2.4
-120T			1.02	4.72	3.46							22,000	2.5
-135T			1.13	5.31	4.06							20,000	2.7
-MEGA8S-90T	.116-.317	.709	.96	3.54	2.28	1.22	1.99	M9 P0.75	NBC8S-□	MGN8S	MGR18	30,000	2.5
-120T			1.17	4.72	3.46							22,000	2.6

- MEGA MICRO NUT is included, collet and wrench must be ordered separately
- Weight includes nut but not collet
- Please note that the practical spindle speed may be considerably influenced by the machine rigidity and tool balance, when using, slowly ramp up to the appropriate speed starting from slow speeds

ACCESSORIES



MEGA MICRO CHUCK

CLAMPING RANGE: ϕ .018"-.317" For Micro Drill & End Mill Applications

MAX
40,000
RPM

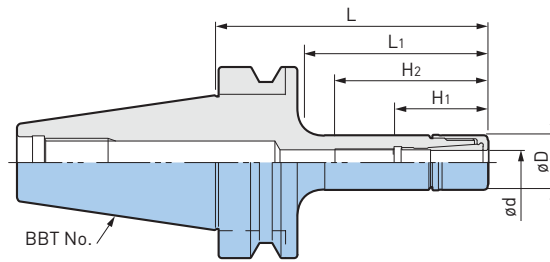

A.2
BBT/BT

Catalog Number	ϕd	ϕD	L	L1	H1	H2	G	Collet	Nut	Wrench	Max RPM	Weight (lbs.)
BBT30-MEGA4S-90	.018-.159	.472	3.54	2.44	1.04	1.85	M5 P.08	NBC4S-□	MGN4S	MGR12	40,000	.9
-MEGA6S-60			2.36	1.26								
-90	.018-.238	.551	3.54	2.44	1.12	1.93	M7 P0.75	NBC6S-□	MGN6S	MGR14	40,000	1.0
-105			4.13	2.87								
-MEGA8S-90	.116-.317	.709	3.54	2.36	1.22	1.99	M9 P0.75	NBC8S-□	MGN8S	MGR18	35,000	1.1
BBT40-MEGA4S-90	.018-.159	.472	3.54	2.09	1.04	1.85	M5 P0.8	NBC4S-□	MGN4S	MGR12	35,000	2.2
-MEGA6S-90	.018-.238	.551	3.54	2.09	1.12	1.93	M7 P0.75	NBC6S-□	MGN6S	MGR14	35,000	2.2
-MEGA8S-90	.116-.317	.709	3.54	2.17	1.22	1.99	M9 P0.75	NBC8S-□	MGN8S	MGR18	30,000	2.4

- MEGA MICRO NUT is included, collet and wrench must be ordered separately
- Weight includes nut but not collet
- Please note that the practical spindle speed may be considerably influenced by the machine rigidity and tool balance, when using, slowly ramp up to the appropriate speed starting from slow speeds

ACCESSORIES



MEGA NEW BABY CHUCK

CLAMPING RANGE: ϕ .010"-1.000" (ϕ .25-25.4mm) For Drills, Reamers, Taps & Finishing End Mills

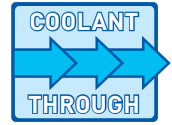

**MAX
40,000
RPM**

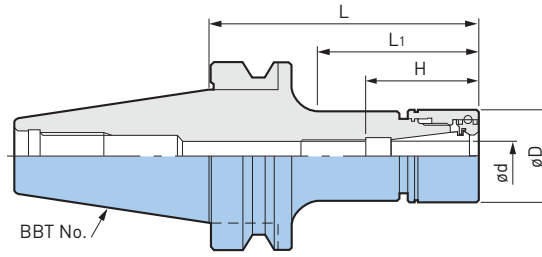

BBT/BT A.2

Catalog Number	ϕd	ϕD	L	L1	H	Collet	Nut	Wrench	Max RPM	Weight (lbs.)
BBT30-MEGA6N-60	.010-.236	.787	2.36	1.26	.91-1.69	NBC6-□	MGN6	MGR20	40,000	1.0
-75			2.95	1.85					35,000	1.1
-90			3.54	2.44					30,000	1.2
-105			4.13	3.03					20,000	1.2
-120			4.72	3.54					18,000	1.3
-MEGA8N-60	.059-.394	.984	2.36	1.34	1.02-1.77	NBC8-□	MGN8	MGR25	40,000	1.1
-75			2.95	1.93					35,000	1.2
-90			3.54	2.52					30,000	1.4
-105			4.13	3.11					20,000	1.5
-120			4.72	3.70					18,000	1.6
-MEGA10N-60	.059-.394	1.181	2.36	1.34	1.50-1.89	NBC10-□	MGN10	MGR30	40,000	1.2
-75			2.95	1.93					30,000	1.4
-90			3.54	2.52					25,000	1.5
-105			4.13	3.11					18,000	1.7
-120			4.72	3.62					15,000	1.8
-MEGA13N-60	.098-.512	1.378	2.36	1.34	1.73-2.48	NBC13-□	MGN13	MGR35	40,000	1.2
-75			2.95	1.93					30,000	1.4
-90			3.54	2.52					25,000	1.6
-105			4.13	3.11					18,000	1.8
-120			4.72	3.70					15,000	2.0
-MEGA16N-60	.098-.630	1.654	2.36	1.46	1.89-2.48	NBC16-□	MGN16	MGR42	35,000	1.5
-75			2.95	2.05	1.89-2.68				25,000	1.8
-90			3.54	2.64					20,000	2.1
-105			4.13	3.23					18,000	2.4
-120			4.72	3.82					15,000	2.7
-MEGA20N-60 ❖	.098-.787	1.811	2.36	—	2.01	NBC20-□	MGN20	MGR46	30,000	1.6
-75			2.95	—	2.01-2.68				20,000	1.9
-90			3.54	—					15,000	2.2
-105			4.13	—					13,000	2.5
-120			4.72	—					12,000	2.5
-MEGA25N-85 ❖	.610-1.000	2.362	3.35	—	3.15	NBC25-□	MGN25	MGR60	12,000	2.5
BBT40-MEGA6N-60	.010-.236	.787	2.36	1.06	1.91-1.69	NBC6-□	MGN6	MGR20	35,000	2.2
-75			2.95	1.50					35,000	2.3
-90			3.54	2.09					35,000	2.4
-105			4.13	2.68					20,000	2.5
-120			4.72	3.27					20,000	2.6
-135			5.31	3.86					20,000	2.7
-165			6.50	5.04					14,000	2.7
-200			7.87	6.42					9,000	2.9

Catalog Number	ød	øD	L	L ₁	H	Collet	Nut	Wrench	Max RPM	Weight (lbs.)
BBT40-MEGA8N-60	.020-.315	.984	2.36	1.06	1.02-1.77	NBC8-□	MGN8	MGR25	35,000	2.2
-75			2.95	1.50					35,000	2.3
-90			3.54	2.09					35,000	2.4
-105			4.13	2.68					20,000	2.5
-120			4.72	3.27					20,000	2.6
-135			5.31	3.86					20,000	2.9
-165			6.50	5.04					14,000	2.9
-200			7.87	6.42					9,000	3.1
-MEGA10N-60			.059-.394	1.181					2.36	1.02
-75	2.95	1.50			35,000	2.5				
-90	3.54	2.09			35,000	2.7				
-105	4.13	2.68			20,000	2.8				
-120	4.72	3.27			20,000	3.0				
-135	5.31	3.86			20,000	3.1				
-165	6.50	5.04			15,000	3.3				
-200	7.87	6.50			10,000	3.8				
-MEGA13N-60	.098-.512	1.378			2.36	1.22	1.73-2.48	NBC13-□	MGN13	MGR35
-75			2.95	1.57	35,000	2.7				
-90			3.54	2.17	35,000	2.9				
-105			4.13	2.76	20,000	3.1				
-120			4.72	3.35	20,000	3.3				
-135			5.31	3.94	20,000	3.5				
-165			6.50	5.12	15,000	4.0				
-200			7.87	6.50	10,000	4.4				
-MEGA16N-60			.098-.630	1.654	2.36	1.22				
-75	2.95	1.57			30,000	2.9				
-90	3.54	2.17			30,000	3.1				
-105	4.13	2.76			20,000	3.5				
-120	4.72	3.35			20,000	3.8				
-135	5.31	3.94			20,000	4.0				
-165	6.50	5.12			15,000	4.4				
-200	7.87	6.50			10,000	5.1				

- MEGA NEW BABY NUT is included, collet, wrench and adjusting screw must be ordered separately
- Weight includes nut but not collet
- Center through coolant supply is available
- Please note that the practical spindle speed may be considerably influenced by the machine rigidity and tool balance, when using, slowly ramp up to the appropriate speed starting from slow speeds
- "H" indicates the adjustment length with an adjusting screw
- "H" dimension is the Max tool shank length that can be inserted into the holder
- Adjusting screws cannot be used with models marked ❖

ACCESSORIES

 <p>COLLET PG. 338</p>	 <p>MEGA NUT PG. 344</p>	 <p>PERFECT SEAL PG. 346</p>	 <p>MEGA WRENCH PG. 368</p>	 <p>SCREW PG. 389</p>
---	---	---	--	--

MEGA NEW BABY CHUCK

CLAMPING RANGE: ϕ .010"-1.000" (ϕ .25-25.4mm) For Drills, Reamers, Taps & Finishing End Mills

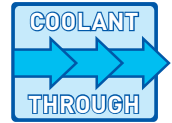

**MAX
40,000
RPM**

BBT/BT A.2

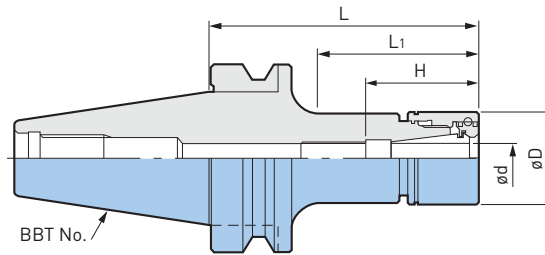

Catalog Number	ϕd	ϕD	L	L1	H	Collet	Nut	Wrench	Max RPM	Weight (lbs.)
BBT40-MEGA20N-60	.098-.787	1.811	2.36	1.22	2.01-2.68	NBC20-□	MGN20	MGR46	30,000	2.4
-75			2.95	1.65					30,000	2.8
-90			3.54	2.24					30,000	3.1
-105			4.13	2.83					20,000	3.5
-120			4.72	3.43					20,000	4.0
-135			5.31	4.02					20,000	4.2
-165			6.50	5.20					15,000	4.6
-200			7.87	6.57					10,000	5.5
-MEGA25N-75			.610-1.000	2.362					2.95	1.85
-90	3.54	2.44			20,000	4.2				
-105	4.13	3.03			19,000	4.8				
-120	4.72	3.62			17,000	5.5				



Catalog Number	ød	øD	L	L1	H	Collet	Nut	Wrench	Max RPM	Weight (lbs.)
BBT50-MEGA6N-90	.010-.236	.787	3.54	1.06	.91-1.69	NBC6-□	MGN6	MGR20	20,000	8.2
-120			4.72	1.50					20,000	8.4
-165			6.50	2.09					14,000	8.6
-200			7.87	2.68					9,000	8.8
-MEGA8N-90	.020-.315	.984	3.54	1.06	1.02-1.77	NBC8-□	MGN8	MGR25	20,000	8.4
-120			4.72	1.50					20,000	8.6
-165			6.50	2.09					16,000	9.0
-200			7.87	2.68					11,000	9.3
-MEGA10N-90	.059-.394	1.181	3.54	1.02	1.50-1.89	NBC10-□	MGN10	MGR30	20,000	8.6
-120			4.72	1.50					20,000	8.8
-165			6.50	2.09					16,000	9.5
-200			7.87	2.68					13,000	10.4
-250			9.84	3.27					8,000	10.4
-300			11.81	3.86					5,500	10.8
-MEGA13N-90	.098-.512	1.378	3.54	1.22	1.73-2.48	NBC13-□	MGN13	MGR35	18,000	8.8
-120			4.72	1.57					18,000	9.3
-165			6.50	2.17					16,000	9.9
-200			7.87	2.76					12,000	10.4
-250			9.84	3.35					8,000	11.0
-300			11.81	3.94					5,500	11.7
-MEGA16N-75	.098-.630	1.654	2.95	1.22	1.89-2.68	NBC16-□	MGN16	MGR42	17,000	8.8
-90			3.54	1.57					17,000	9.3
-120			4.72	2.17					17,000	9.7
-165			6.50	2.76					16,000	10.6
-200			7.87	3.35					13,000	11.2
-250			9.84	3.94					10,000	12.1
-MEGA20N-75	.098-.787	1.811	2.95	1.22	2.01-2.68	NBC20-□	MGN20	MGR46	16,000	9.0
-90			3.54	1.65					16,000	9.3
-120			4.72	2.24					16,000	9.9
-165			6.50	2.83					15,000	10.8
-200			7.87	3.43					13,000	11.7
-250			9.84	4.02					10,000	12.6
-MEGA25N-90	.610-1.000	2.362	3.54	1.81	2.52-2.91	NBC25-□	MGN25	MGR60L	19,000	9.5
-120			4.72	2.83					17,000	10.8
-165			6.50	4.61					15,000	12.8
-200			7.87	5.98					13,000	14.1

- MEGA NEW BABY NUT is included, collet, wrench and adjusting screw must be ordered separately
- Weight includes nut but not collet
- Center through coolant supply is available
- Please note that the practical spindle speed may be considerably influenced by the machine rigidity and tool balance, when using, slowly ramp up to the appropriate speed starting from slow speeds
- "H" indicates the adjustment length with an adjusting screw

ACCESSORIES



MEGA ER GRIP

CLAMPING RANGE: $\varnothing.075$ " - $.787$ " ($\varnothing1.9$ - 20 mm)

For Drills, Reamers, Taps & Finishing End Mills

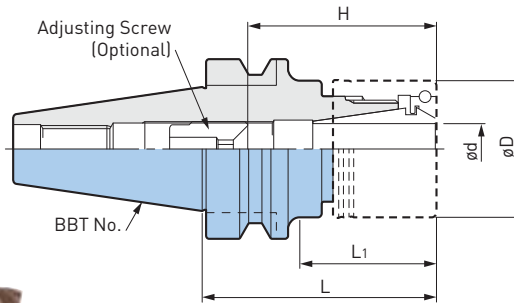
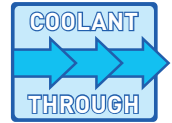

Catalog Number	$\varnothing d$	$\varnothing D$	L	L ₁	H	Collet	Nut (NOT Included)	Wrench
BBT30-MEGAER16-60NL	.075-.394	1.181	2.36	1.38	1.38-1.85	ERC16-□	MERN16*	MGR30L
-75NL			2.95	1.93				
-90NL			3.54	2.52				
-MEGAER20-60NL	.108-.512	1.378	2.36	1.38	1.65-2.36	ERC20-□	MERN20*	MGR35L
-75NL			2.95	1.97				
-90NL			3.54	2.56				
-MEGAER25-60NL	.108-.630	1.654	2.36	1.46	1.73-2.24	ERC25-□	MERN25*	MGR42L
-75NL			2.95	2.05				
-90NL			3.54	2.64				
-MEGAER32-60NL	.108-.787	1.969	2.36	1.50	1.97	ERC32-□	MERN32*	MGR50L
-75NL			2.95	2.09				
-90NL			3.54	2.68				
BBT40-MEGAER16-60NL	.075-.394	1.181	2.36	1.18	1.38-1.85	ERC16-□	MERN16*	MGR30L
-90NL			3.54	2.17				
-105NL			4.13	2.76				
-135NL			5.31	3.94				
-165NL			6.50	5.12				
-MEGAER20-60NL	.108-.512	1.378	2.36	1.26	1.65-2.44	ERC20-□	MERN20*	MGR35L
-90NL			3.54	2.20				
-105NL			4.13	2.80				
-135NL			5.31	3.98				
-165NL			6.50	5.16				
-MEGAER25-60NL ❖	.108-.630	1.654	2.36	1.26	1.73-2.64	ERC25-□	MERN25*	MGR42L
-90NL			3.54	2.24				
-105NL			4.13	2.83				
-135NL			5.31	4.02				
-165NL			6.50	5.20				
-MEGAER32-60NL	.108-.787	1.969	2.36	1.30	1.97-2.68	ERC32-□	MERN32*	MGR50L
-90NL			3.54	2.36				
-105NL			4.13	2.95				
-135NL			5.31	4.13				
-165NL			6.50	5.31				

Catalog Number	ød	øD	L	L1	H	Collet	Nut (NOT Included)	Wrench
BBT50-MEGAER16-105NL	.075-.394	1.181	4.13	2.32	1.38-1.85	ERC16-□	MERN16*	MGR30L
-135NL			5.31	3.31				
-165NL			6.50	4.49				
-MEGAER20-105NL	.108-.512	1.378	4.13	2.36	1.65-2.44	ERC20-□	MERN20*	MGR35L
-135NL			5.31	3.35				
-165NL			6.50	4.53				
-MEGAER25-105NL	.108-.630	1.654	4.13	2.32	1.73-2.64	ERC25-□	MERN25*	MGR42L
-135NL			5.31	3.50				
-165NL			6.50	4.69				
-MEGAER32-105NL	.108-.787	1.969	4.13	2.32	1.97-2.68	ERC32-□	MERN32*	MGR50L
-135NL			5.31	3.50				
-165NL			6.50	4.69				

***Nut, adjusting screw, balance screws, collet and wrench are not included**

- Weight does not include collet
- MEGA ER GRIP is not able to use DIN6499 Form-A collets and ESX collets
- Please note that the practical spindle speed may be considerably influenced by the machine rigidity and tool balance, when using, slowly ramp up to the appropriate speed starting from slow speeds
- "H" indicates the adjustment length with an adjusting screw
- Adjusting screws cannot be used with models marked ❖

CAUTION ⚠

To maintain the accuracy of the tool assembly, do not use collets and nuts manufactured by another company with the chuck body of BIG's MEGA ER GRIP. We cannot guarantee the accuracy statement for our collets if they are assembled on the chuck body of another manufacturer.

ACCESSORIES



*MEGA NUT is the recommended nut to achieve high accuracy and clamping force

HIGH CONCENTRICITY



MEGA ER PERFECT SEAL



MEGA WRENCH

Capable of sealing high pressure coolant up to 7Mpa. For applications with coolant supplied through the tools. MEGA Wrench is used for tightening.



MEGA ER NUT*



MEGA WRENCH

High accuracy and clamping force are provided with thrust ball bearings. Ideal for solid carbide drills and reamers. Slot-free outer diameter increases rigidity of the nut itself. The one-way clutch of the MEGA Wrench tightens the nut securely and easily by ratchet function.



MEGA ER SOLID NUT



MEGA WRENCH

High performance solid nut with surface treatment for friction reduction. Slot-free outer diameter increases rigidity of the nut itself. The one-way clutch of the MEGA Wrench tightens the nut securely and easily by ratchet function.



ER NUT



C-SPANNER

Basic nut with surface treatment for friction reduction. C-Spanner is used for tightening.

*MEGA NUT is the recommended nut to achieve high accuracy and clamping force

MEGA E CHUCK

CLAMPING RANGE: ϕ .125"-.500" (ϕ 3-12mm)
 Exclusively for High Speed Finish End Milling

MAX
40,000
RPM

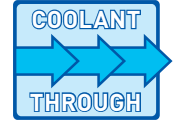

BBT/BT A.2

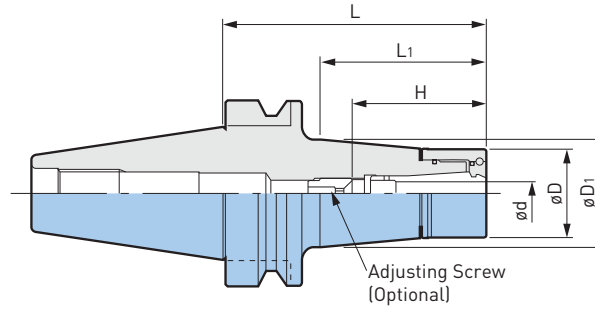

Catalog Number	ϕd	ϕD	$\phi D1$	L	L1	H		Collet	Nut	Wrench	Max RPM	Weight (lbs.)
						Min	Max					
BBT30-MEGA6E-50	.125-.250 (3-6mm)	.984	1.01	1.97	.98	1.46	1.77	MEC6-□	MEN6	MGR25	40,000	1.2
-75			1.18	2.95	1.97						35,000	1.4
-90			1.28	3.54	2.56						25,000	1.6
-105			1.38	4.13	3.15						25,000	1.8
-MEGA8E-50	.125-.250 (3-8mm)	1.181	1.20	1.97	.98	1.65	2.01	MEC8-□	MEN8	MGR30	40,000	1.2
-75			1.36	2.95	1.97						35,000	1.6
-90			1.47	3.54	2.60						25,000	1.8
-105			1.58	4.13	3.19						25,000	2.1
-MEGA10E-50	.125-.375 (3-10mm)	1.378	1.39	1.97	.98	1.89	2.28	MEC10-□	MEN10	MGR35	39,000	1.3
-75			1.56	2.95	2.01						35,000	1.8
-90			1.61	3.54	2.62						25,000	2.1
-105			1.62	4.13	3.23						25,000	2.3
-MEGA13E-50	.125-.500 (3-12mm)	1.654	1.67	1.97	1.06	1.97	2.38	MEC13-□	MEN13	MGR42	38,000	1.4
-75			1.65	2.95	2.05	1.97	2.36				34,000	2.0
-90			1.65	3.54	2.64	1.97	2.36				25,000	2.3
-105			1.65	4.13	3.23	1.97	2.36				25,000	2.7
BBT40-MEGA6E-60	.125-.250 (3-6mm)	.984	1.03	2.36	1.10	1.46	1.77	MEC6-□	MEN6	MGR25	30,000	2.4
-75			1.13	2.95	1.69						30,000	2.5
-90			1.23	3.54	2.28						30,000	2.7
-105			1.33	4.13	2.87						29,000	2.9
-120			1.44	4.72	3.46						29,000	3.1
-135			1.54	5.31	4.06						27,000	3.4
-165			1.75	6.50	5.24						20,000	4.1
-200			2.00	7.87	6.65						15,000	5.1
-MEGA8E-60	.125-.250 (3-8mm)	1.181	1.22	2.36	1.10	1.65	1.89	MEC8-□	MEN8	MGR30	30,000	2.5
-75			1.31	2.95	1.69	1.65	1.89				30,000	2.7
-90			1.42	3.54	2.28	1.65	1.89				30,000	2.9
-105			1.52	4.13	2.87	1.65	1.89				29,000	3.2
-120			1.63	4.72	3.46	1.65	1.89				29,000	3.6
-135			1.73	5.31	4.06	1.65	1.89				27,000	3.9
-165			1.93	6.50	5.24	1.65	1.89				20,000	4.6
-200			2.20	7.87	6.73	1.65	1.89				15,000	5.6

Catalog Number	ød	øD	øD1	L	L1	H		Collet	Nut	Wrench	Max RPM	Weight (lbs.)
						Min	Max					
BBT40-MEGA10E-60	.125-.375 (3-10mm)	1.378	1.42	2.36	1.14	1.89	2.28	MEC10-□	MEN10	MGR35	30,000	2.7
-75			1.51	2.95	1.69						30,000	3.0
-90			1.61	3.54	2.28						30,000	3.2
-105			1.72	4.13	2.87						29,000	3.6
-120			1.82	4.72	3.46						29,000	3.9
-135			1.92	5.31	4.06						27,000	4.4
-165			2.14	6.50	5.31						22,000	5.2
-200			2.19	7.87	6.73						16,000	6.8
-MEGA13E-60			.125-.500 (3-12mm)	1.654	1.68						2.36	1.14
-75	1.77	2.95			1.69	30,000	3.2					
-90	1.89	3.54			2.32	30,000	3.6					
-105	1.99	4.13			2.95	29,000	4.1					
-120	2.10	4.72			3.58	29,000	4.6					
-135	2.20	5.31			4.17	26,000	5.2					
-165	2.26	6.50			5.39	22,000	6.2					
-200	2.46	7.87			6.77	16,000	8.0					
BBT50-MEGA6E-90	.125-.250 (3-6mm)	.984			1.20	3.54	1.85	1.46	1.77	MEC6-□	MEN6	MGR25
-120			1.40	4.72	3.03	20,000	8.8					
-165			1.71	6.50	4.80	14,000	9.7					
-200			1.95	7.87	6.18	9,000	10.8					
-MEGA8E-90	.125-.250 (3-8mm)	1.181	1.38	3.54	1.85	1.65	2.01	MEC8-□	MEN8	MGR30	20,000	5.6
-120			1.59	4.72	3.03						20,000	9.0
-165			1.90	6.50	4.80						16,000	10.1
-200			2.14	7.87	6.18						11,000	11.4
-MEGA10E-90	.125-.375 (3-10mm)	1.378	1.57	3.54	1.85	1.89	2.28	MEC10-□	MEN10	MGR35	20,000	8.8
-120			1.79	4.72	3.03						20,000	9.2
-165			2.09	6.50	4.76						16,000	10.8
-200			2.33	7.87	6.14						13,000	12.1
-MEGA13E-90	.125-.500 (3-12mm)	1.654	1.83	3.54	1.85	1.97	2.36	MEC13-□	MEN13	MGR42	18,000	8.8
-120			2.05	4.72	3.03						18,000	9.7
-165			2.32	6.50	4.76						16,000	11.4
-200			2.55	7.87	6.14						12,000	13.2

- MEGA E NUT is included, collet, wrench and adjusting screw must be ordered separately
- Weight includes nut but not collet
- Center through coolant supply is available
- Please note that the practical spindle speed may be considerably influenced by the machine rigidity and tool balance, when using, slowly ramp up to the appropriate speed starting from slow speeds
- "H" indicates the adjustment length with an adjusting screw

ACCESSORIES



MEGA DOUBLE POWER CHUCK

CLAMPING RANGE: ϕ .625"-1.500" (ϕ 16-50mm)

For Heavy Duty End Milling

MAX
30,000
RPM

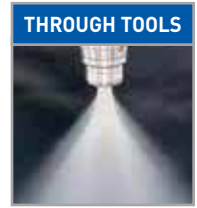

BBT/BT
A.2

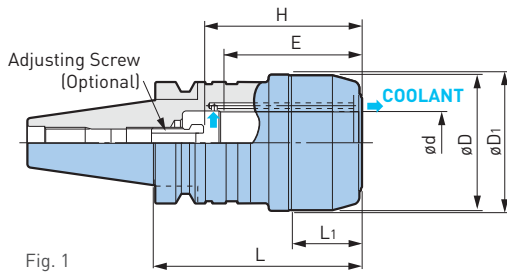

Fig. 1

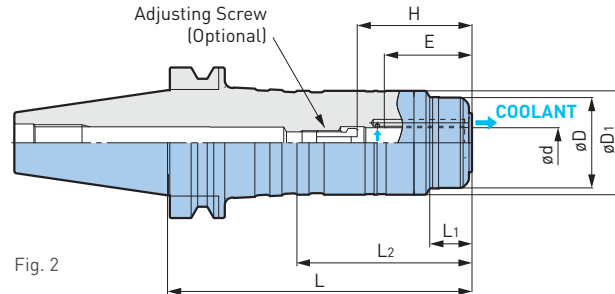

Fig. 2



Catalog Number	Fig.	ϕd	ϕD	ϕD_1	L	L ₁	L ₂	H	Min Clamping Length E	Wrench	Max RPM	Weight (lbs.)
BBT30-MEGA.750DS-2.5	1	.750	1.969	2.00	2.59	1.26	1.48	2.36	2.05	MGR50L	30,000	1.8
-MEGA16DS-60		16mm	1.811	1.85	2.46	1.10	—	2.52		MGR46L	30,000	1.7
-MEGA20DS-65		20mm	1.969	2.00	2.66	1.30	—	2.36		MGR50L	25,000	1.8
BBT40-MEGA.625DS-3A	2	.625	1.654	2.09	3.08	1.06	1.57	2.87	2.24	MGR42L	30,000	3.5
-5A					5.08						25,000	5.6
-MEGA.750DS-3A	2	.750	1.969	2.17	3.08	1.42	1.81	2.80-3.19	2.28	MGR50L	30,000	3.5
-5A					5.08						25,000	5.7
-MEGA1.000DS-3.5A	1	1.000	2.441	2.48	3.58	1.61	1.85	2.87-3.27	2.32	MGR62L	27,000	4.5
-5A					5.08						24,000	6.4
-MEGA1.250DS-3.5A	1	1.250	2.756	2.78	3.58	1.38	1.87	3.19-3.58	2.60	MGR70L	26,000	4.8
-5A					5.08						22,000	6.6
-MEGA16DS-75A	2	16mm	1.654	2.09	3.03	1.06	1.57	2.87	2.24	MGR42L	30,000	3.3
-105A					4.21						30,000	4.6
-135A					5.39						25,000	5.7
-165A					6.57						22,000	7.3
-200A					7.87						20,000	9.0
-MEGA20DS-75A	2	20mm	1.969	2.17	3.03	1.42	1.81	2.80-3.19	2.28	MGR50L	30,000	3.5
-105A					4.21						30,000	4.4
-120A					4.80						27,000	5.1
-135A					5.39						25,000	5.7
-165A					6.57						22,000	7.0
-200A					7.87						20,000	9.0
-MEGA25DS-75A	1	25mm	2.441	2.48	3.03	1.61	—	2.95-3.35	2.32	MGR62L	27,000	4.4
-105A					4.21			26,000			5.1	
-135A					5.39			24,000			6.6	
-165A					6.57			21,000			8.1	
-200A					7.95			18,000			10.3	

Catalog Number	Fig.	ød	øD	øD1	L	L1	L2	H	Min Clamping Length E	Wrench	Max RPM	Weight (lbs.)
BBT40-MEGA32DS-90A	1	32mm	2.756	2.80	3.62	1.38	—	2.87-3.27	2.60	MGR70L	26,000	4.6
-105A					4.21			26,000			5.3	
-135A					5.39			22,000			6.8	
-165A					6.57			20,000			8.1	
-200A					7.95			16,000			9.9	
BBT50-MEGA.750DS-4					2			.750			2.362	2.72
-MEGA1.000DS-4	1.000	2.756	3.03	4.09		1.34	1.85	3.07-3.46	2.64	MGR70L	20,000	10.6
-MEGA1.250DS-4	1.250	3.150	3.39	4.09		1.65	2.24	3.03-3.70	2.87	MGR80L	20,000	11.3
-MEGA1.500DS-4.5	1	1.500	3.898	3.94	4.58	1.65	—	3.54-4.21	2.87	MGR99L	15,000	14.6
-MEGA16DS-105	2	16mm	1.811	2.17	4.23	1.02	1.42	2.87	2.05	MGR46L	21,000	10.1
-135					5.41						21,000	11.4
-165					6.59						19,000	12.5
-200					7.97						15,000	14.5
-250					9.94						13,000	15.4
-MEGA20DS-105					2						20mm	2.362
-135	5.41	19,000	13.2									
-165	6.59	17,000	15.0									
-200	7.97	14,000	16.9									
-250	9.94	12,000	20.0									
-MEGA25DS-105	2	25mm	2.756	3.03	4.23	1.34	1.80	3.07-3.46	2.64	MGR70L	20,000	11.9
-135					5.41						19,000	14.3
-165					6.59						17,000	16.7
-200					7.97						12,000	19.6
-250					9.94						10,000	23.8
-MEGA32DS-90	2	32mm	3.150	3.39	3.72	1.65	2.24	3.15-3.82	2.87	MGR80L	20,000	10.6
-105					4.23						20,000	11.9
-135					5.41						18,000	15.4
-165					6.59						15,000	18.7
-200					7.97						12,000	21.8
-250					9.94						10,000	26.6
-300					11.91						5,000	31.5
-MEGA42DS-105	1	42mm	3.898	3.93	4.21	1.65	—	3.54-4.21	2.87	MGR99L	15,000	13.2
-135					5.39						15,000	17.2
-165					6.57						14,000	21.1
-MEGA50DS-120	1	50mm	4.134	4.61	4.80	1.93	—	3.78-4.41	3.03	MGR105L	13,000	16.1

- Wrench must be ordered separately
- Please note that the practical spindle speed may be considerably influenced by the machine rigidity and tool balance, when using, slowly ramp up to the appropriate speed starting from slow speeds
- MEGA16DS requires the hex socket head screw (M8) for axial adjustment, however, please contact us if using for center through applications
- "H" indicates the adjustment length with an adjusting screw
- "H" dimension is the Max tool shank length that can be inserted into the holder
- DS types have jet-through coolant supply, thus tools with holes cannot be used

ACCESSORIES



MEGA PERFECT GRIP

CLAMPING RANGE: ϕ 16-32mm

The unique Key Grip locking mechanism prevents the tool from slipping or pulling out during heavy machining.

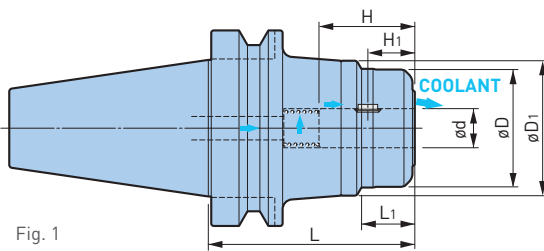
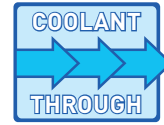

Fig. 1

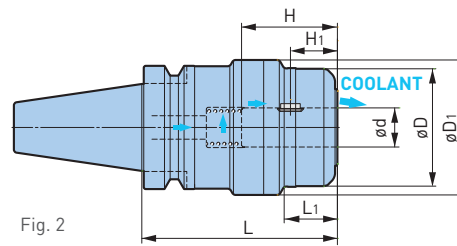

Fig. 2



Catalog Number	Fig.	ϕd	ϕD	ϕD_1	L	L ₁	H	H ₁	MEGA WRENCH	Weight (lbs.)
BBT40-MEGA16DPG-75	1	16mm	1.811	2.165	2.95	.945	1.85	.91	MGR46L	3.7
-MEGA20DPG-100	2	20mm	2.362	2.717	3.94	1.063	1.93	.94	MGR60L	5.7
BBT50-MEGA16DPG-105	1	16mm	1.811	2.165	4.13	.945	1.85	.91	MGR46L	10.1
-165					6.50					12.8
-MEGA20DPG-105		20mm	2.362	2.717	4.13	1.063	1.93	.94	MGR60L	11.2
-165					6.50					15.2
-MEGA25DPG-105		25mm	2.756	3.031	4.13	1.299	2.17	.91	MGR70L	11.9
-165					6.50					17.0
-MEGA32DPG-105		32mm	3.150	3.386	4.13	1.614	2.32	.91	MGR80L	12.3
-165					6.50					18.5

- Key grip and spring are included, wrench must be ordered separately
- H₁ is the dimension from the center of the Key Grip to the front end of the chuck
- When coolant supply is from the cutting edge a seal bush is necessary, use instead of the spring; seal bush must be ordered separately

CAUTION

Key Grips are consumable products. Do not use a damaged Key Grip.

Clamping ϕ	Key Grip (2 pcs.)	Spring
ϕ 16	PKG16-2P	PSP1519
ϕ 20	PKG20-2P	PSP1823
ϕ 25	PKG25-2P	PSP2420
ϕ 32	PKG32-2P	PSP3128

- Spare Key Grips are available in 2 pcs. per set

CYLINDRICAL SHANK WITH FLAT SECTION JIS B 4005 (ISO3338-2)

The following standard shank is required for MEGA PERFECT GRIP.



øD		L	L ₁	W		K	
Nominal	Tolerance			Nominal	Tolerance	Nominal	Tolerance
16	0 -0.011	48mm	24mm	10	+2 0	14.2	0 -0.4
20	0 -0.013	50mm	25mm	11			
25		56mm	32mm	12			
32	0 -0.016	60mm	36mm	14			

- JIS Standards require sizes ø25 or higher to be double-flat types. The MEGA Perfect GRIP does not use a rear flat surface, but is capable of clamping double flat shanks.
- JIS B4005 has the same dimensions as International Standard ISO3338-2 and German Standard DIN1835-1.

CAUTION ⚠

In case you are adding your own flat, the tool projection length in the MEGA PERFECT GRIP will be decided by the flat position. Refer to H₁ in the MEGA PERFECT GRIP chart, decide the flat position to add, and then cut the cutter at L₁ on cutter shank.



NEW Hi-POWER MILLING CHUCK

CLAMPING RANGE: ϕ .750"-1.250" (ϕ 16-42mm)
For Heavy Duty End Milling

BBT/BT A.2

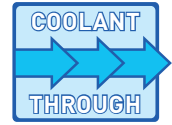
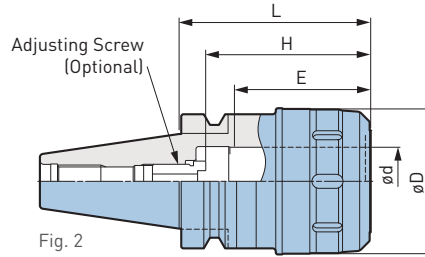
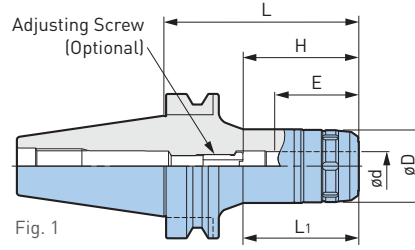

Catalog Number	Fig.	ϕd	ϕD	L	L1	H	Min Clamping Length E	Wrench	Weight (lbs.)
BBT30-HMC.750S-3	2	.750	1.969	3.00	—	2.16-2.55	2.21	FK45-50L	2.1
-HMC16S-70 \diamond	1	16mm	1.693	2.76	1.85	2.80	2.17	FK45-50L	1.5
-HMC20S-75	2	20mm	1.969	2.95	—	2.20-2.59	2.21		2.0
-HMC25S-90		25mm	2.165	3.54	—	2.52-2.91	2.24	FK52-55	2.6
-HMC32S-105		32mm	2.441	4.13	—	2.75-3.15	2.28	FK58-62L	3.3
BBT40-HMC.750S-3.5	1	.750	1.969	3.50	2.31	2.71-3.11	2.21	FK45-50L	4.1
-HMC1.000S-3.5		1.000	2.323	3.50	2.42	2.87-3.26	2.24	FK58-62L	4.7
-HMC1.250S-4	2	1.250	2.677	4.00	—	3.11-3.50	2.52	FK68-75L	5.9
-HMC16S-75 \diamond	1	16mm	1.693	2.95	1.77	2.80	2.17	FK45-50L	2.9
-120 \diamond				4.72	3.54				4.0
-HMC20S-75	1	20mm	1.969	2.95	1.81	2.72-3.11	2.21	FK45-50L	3.1
-105				4.13	2.95				4.2
-120				4.72	3.54				4.6
-HMC25S-75	1	25mm	2.323	2.95	1.85	2.87-3.27	2.24	FK58-62L	3.3
-105				4.13	3.03				4.6
-135				5.31	4.21				6.2
-HMC32S-90	2	32mm	2.677	3.54	—	2.80-3.19	2.52	FK68-75L	4.4
-105				4.13	—				5.1
-135				5.31	—	6.6			
BBT50-HMC.750-4	1	.750	2.360	4.00	2.36	2.71-3.11	2.21	FK58-62	10.5
-HMC1.000-4		1.000	2.440	4.00	2.32	2.99-3.38	2.56	FK58-62	10.7
-HMC1.250-4		1.250	3.150	4.00	2.48	3.07-3.74	2.80	FK80-90	12.4
-HMC16S-105 \diamond	1	16mm	1.693	4.13	2.24	2.80	2.17	FK45-50L	9.3
-135 \diamond				5.31	3.15				10.1
-165 \diamond				6.50	3.94				11.0
-200 \diamond				7.87	4.72				12.8
-HMC20S-105	1	20mm	1.969	4.13	2.24	2.72-3.11	2.21	FK45-50L	9.5
-135				5.31	3.15				10.6
-165				6.50	3.94				11.9
-200				7.87	4.92				13.2
-300				11.81	7.87				18.3

Catalog Number	Fig.	ød	øD	L	L ₁	H	Min Clamping Length E	Wrench	Weight (lbs.)
BBT50-HMC25S-105	1	25mm	2.323	4.13	2.24	2.99-3.39	2.24	FK58-62L	9.9
-135				5.31	3.43				11.5
-165				6.50	4.13				13.0
-200				7.87	4.92				16.5
-HMC32S-105	1	32mm	2.677	4.13	2.52	3.46-3.86	2.83	FK68-75L	10.1
-135				5.31	3.50				11.9
-165				6.50	4.13				14.1
-200				7.87	5.12				16.3
-HMC42S-105	1	42mm	3.346	4.13	2.56	3.66-4.13	2.87	FK80-90L	11.5
-135				5.31	3.70				13.7
-165				6.50	4.84				16.3
-200				7.87	5.12				21.2
-300				11.81	7.87				31.1

- Wrench and axial adjusting screw must be ordered separately
- When using center through coolant:
 - Set screw with sealing compound applied (standard accessory) should be used to plug an air bleeding hole
 - Oil hole type should be chosen when straight collet is required
- "H" indicates the adjustment length with an adjusting screw
- HMC16S requires the hex socket head screw (M8) for axial adjustment, however, please contact us if using for center through applications
- "H" dimension is the Max tool shank length that can be inserted into the holder

ACCESSORIES



CLAMPING RANGE: ø1/2" & ø12mm

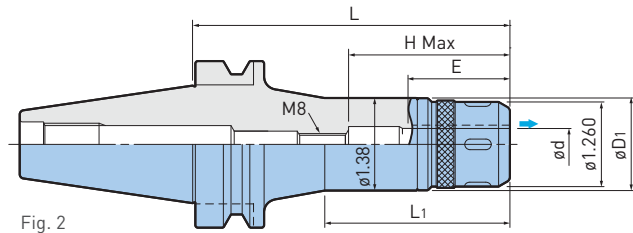
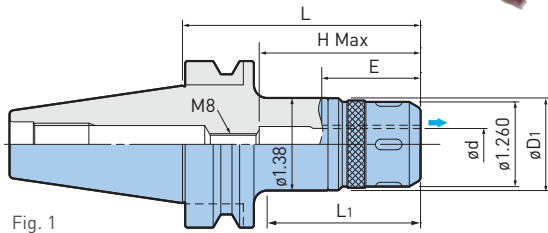
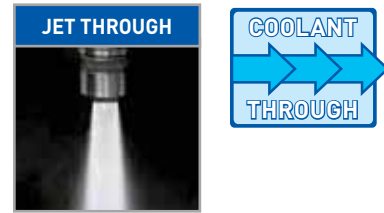

Catalog Number	Fig.	ød	øD ₁	L	L ₁	H Max	Min Clamping Length E	Wrench	Weight (lbs.)
BBT30-HMC.500J-2.5	1	.500	1.38	2.50	1.55	2.56	1.69	FK31-33	1.3
-HMC12J-60	1	12mm	1.38	2.36	1.50	2.56	1.69	FK31-33	1.3
BBT40-HMC12J-90	1	12mm	1.38	3.54	2.48	2.56	1.69	FK31-33	3.1
-120	2			4.72	2.75				3.5
BBT50-HMC12J-105	1	12mm	1.38	4.13	2.64	2.56	1.69	FK31-33	8.8
-135	2			5.31	2.75				9.5
-165				6.50	3.54				10.3

- Wrench must be ordered separately

SUPER SLIM TYPE

CLAMPING RANGE: $\varnothing 3\text{mm}-12\text{mm}$, $\varnothing .125''$

For Drills, Reamers, Ball Mills, End Mills, Diamond Reamers & Grinding Tools

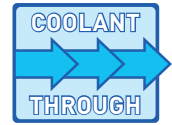

BBT/BT A.2

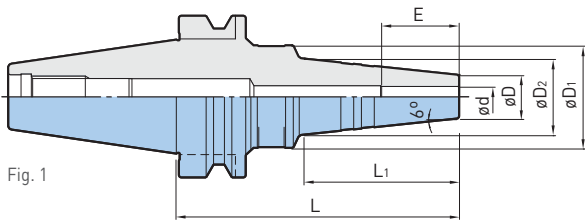

Fig. 1

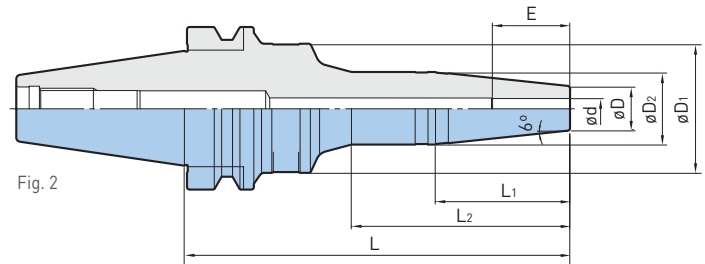

Fig. 2



Catalog Number	Fig.	$\varnothing d$	$\varnothing D$	$\varnothing D_1$	$\varnothing D_2$	L	L1	L2	Min Clamping Length E	Max RPM	Weight (lbs.)
BBT30-HDC3S-90	1	3mm	.551	.98	1.65	3.54	1.97	—	.63	35,000	1.4
-HDC.125S-3.5		.125		.96		3.50	1.96	—		35,000	1.4
-HDC4S-60	1	4mm		.79	1.81	2.36	1.10	—	.75	35,000	1.1
-90				.98	1.65	3.54	1.97	—		.87	35,000
-HDC5S-90	1	5mm		1.65	.98			3.54	1.97	—	.98
-HDC6S-90	1	6mm		1.10	1.65	—	1.18			35,000	1.5
-HDC8S-90		8mm		.748	1.73	1.18	1.26			35,000	1.5
-HDC10S-90		10mm		.827	1.81	1.26	1.38			35,000	1.8
-HDC12S-90		12mm									

Catalog Number	Fig.	ød	øD	øD1	øD2	L	L1	L2	Min Clamping Length E	Max RPM	Weight (lbs.)
BBT40-HDC3S-90	1	3mm	.551	.94	1.50	3.54	1.73	—	.63	35,000	2.9
-HDC4S-60	1	4mm		.75	1.50	2.36	.87	—	.75	30,000	2.6
-90				.94		3.54	1.77	—		30,000	2.9
-135	2			1.02		5.31	2.24	3.31		30,000	3.1
-HDC6S-110	1	6mm	.551	1.50	1.06	4.33	2.36	—	.98	30,000	2.9
-150	2			1.89	1.02	5.91	2.24	3.35		28,000	3.5
-HDC8S-110	1	8mm	.669	1.57	1.18	4.33	2.36	—	1.18	30,000	3.1
-150	2			1.97	1.10	5.91	2.05	3.35		28,000	3.8
-HDC10S-110	1	10mm	.748	1.65	1.26	4.33	2.36	—	1.26	30,000	3.1
-150	2			1.97	1.18	5.91	2.05	3.35		25,000	3.8
-HDC12S-110	1	12mm	.827	1.73	1.34	4.33	2.36	—	1.38	30,000	3.1
-150	2			1.97	1.26	5.91	2.05	3.35		25,000	4.0
BBT50-HDC6S-150	2	6mm	.551	2.05	1.02	5.91	2.24	3.27	.98	20,000	9.3
-200				2.20		7.87		3.94		15,000	10.1
-HDC8S-150		8mm	.669	2.12	1.10	5.91	2.05	3.27	1.18	20,000	9.5
-200				2.28		7.87		3.94		15,000	10.4
-HDC10S-150		10mm	.748	2.20	1.18	5.91	2.05	3.27	1.26	20,000	9.5
-200				2.36		7.87		3.94		15,000	10.6
-HDC12S-150		12mm	.827	2.28	1.26	5.91	2.05	3.27	1.38	20,000	9.7
-200				2.44		7.87		3.94		15,000	10.6

• Adjusting screw cannot be used

CAUTION 

Use only cutting tools that have a shank tolerance of h6 (see table Pg. 26). Do not use with cutting tools made with a flat on the shank (ie: Weldon type shank). Roughing end mills are not recommended for use with HYDRAULIC CHUCKS. Do not tighten the clamping screw without first inserting a cutting tool into the tool holder. Always insert the cutting tool into the hydraulic tool holder beyond min. clamping length "E".

CLAMPING RANGE: ϕ .250"-1.000" (ϕ 6-32mm)

For Drills, Reamers, Ball Mills, End Mills, Diamond Reamers & Grinding Tools

**MAX
40,000
RPM**

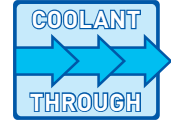

BBT/BT
A.2

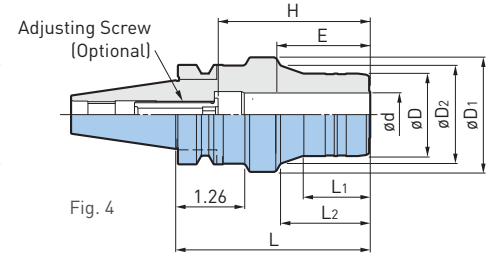
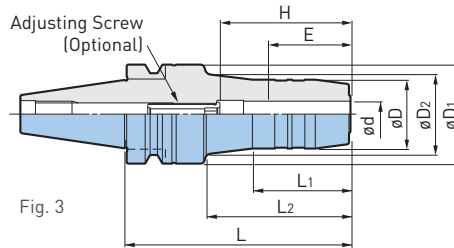
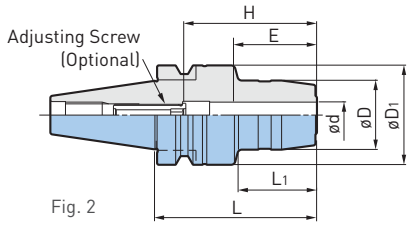
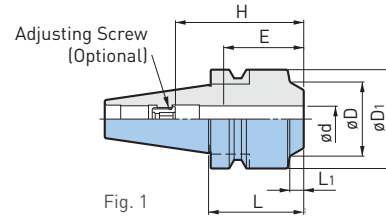

Catalog Number	Fig.	ϕd	ϕD	ϕD_1	ϕD_2	L	L ₁	L ₂	H	Min Clamping Length E	Adjusting Screw	Weight (lbs.)
BBT30-HDC.250-2.5	1	.250	1.024	1.79	—	2.50	1.14	—	1.10-1.97	1.10	HDA6-05032	1.3
-4	2				1.18	4.00	1.69	2.70				
-HDC.375-2.5	1	.375	1.181	1.81	—	2.50	.96	—	1.77-2.17	1.30	HDA10-08015	1.6
-4	2				1.34	4.00	1.77	2.48				
-HDC.500-2.5	1	.500	1.299	1.81	—	2.50	.98	—	1.57-2.36	1.50	HDA12-10025	1.6
-4	2				1.46	4.00	1.77	2.52				
-HDC.625-2.5 \diamond	1	.625	1.496	1.81	—	2.50	.94	—	2.83	1.69	—	1.8
-4	2				1.81	4.00	1.85	2.52				
-HDC.750-2.5	3	.750	1.496	2.09	—	2.50	.55	—	1.69-2.24	1.69	HDA16-12030	2.0
-4					1.77	4.00	1.22	2.09				
-HDC1.000-4	3	1.000	2.165	2.48	2.48	4.00	1.61	1.73	2.05-3.15	2.05	HDA25-16039	3.8

Catalog Number	Fig.	ød	øD	øD1	øD2	L	L1	L2	H	Min Clamping Length E	Adjusting Screw	Weight (lbs.)				
BBT30-HDC6-45	1	6mm	1.181	1.81	—	1.77	.28	—	1.38-1.97	1.10	HDA6-05020	1.5				
-75	2		1.024	1.79		1.22	2.95		1.57		1.10-1.97	HDA6-05032	1.8			
-90	3				3.54		1.69	2.24	2.0							
-105	3				4.13		2.83									
-HDC8-45	1	8mm	1.260	1.81	—	1.77	.28	—	1.38-1.97	1.10	HDA8-06020	1.5				
-75	2		1.102	1.79		1.30	2.95		1.61		1.10-1.97	HDA8-06032	1.8			
-90	3				3.54		1.73	2.24	2.0							
-105	3				4.13		2.83									
-HDC10-45	1	10mm	1.339	1.81	—	1.77	.28	—	1.77-2.17	1.30	HDA10-08015	1.5				
-75	2		1.181			1.30	3.54		1.42		2.01	1.30-2.17	HDA10-08032	2.0		
-90	3				1.42			4.13							2.60	2.2
-105	3				1.42			4.13							2.60	
-HDC12-45	1	12mm	1.417	1.81	—	1.77	.28	—	2.17-2.36	1.50	HDA12-10010●	1.5				
-75	2		1.260			1.38	3.54		1.77		2.01	1.50-2.36	HDA12-10032	2.0		
-90	3				1.50			4.13							2.64	2.2
-105	3				1.50			4.13							2.64	
-HDC14-90	3	14mm	1.339	1.81	1.46	3.54	1.81	2.05	1.50-2.36	1.50	HDA12-10032	2.0				
-HDC16-45❖	1	16mm	1.654	1.81	—	1.77	.28	—	2.76	1.69	—	1.5				
-75	2		1.496			1.81	—		2.95		1.38	1.69-2.76	HDA16-12030	2.0		
-90	3								3.54		1.85				HDA16-12037	2.2
-150	3								5.91		1.85					
-HDC20-60◆	4	20mm	1.496	2.09	—	2.36	—	.55	1.69-2.13	1.69	HDA16-12030	2.0				
-75	4					1.81	2.95	.63	1.02		1.81-2.76	HDA16-12037	2.4			
-90	4				3.54	1.22	1.61	1.69-2.76								
-150	3				1.81	—	5.91		1.57		—			2.2		
-HDC25-105	4	25mm	2.165	2.48	—	4.13	1.73	—	2.05-3.15	2.05	HDA25-16039	3.8				
-HDC32-105	4	32mm	2.362	2.95	—	4.13	1.54	—	2.20-3.15	2.20	HDA25-16039	4.0				

- "H" indicates the adjustment length with an adjusting screw
- Adjusting screws cannot be used with models marked ❖
- Straight collets cannot be used with models marked ◆
- In case the projection length needs to be adjusted from the shank side, add the letter "W" to adjusting screw model number for hexagon sockets on both sides (ex: HDA6-05020W), adjusting screw with ● indication is not available in W type

CAUTION ⚠

Use only cutting tools that have a shank tolerance of h6 (see table Pg. 26). Do not use with cutting tools made with a flat on the shank (ie: Weldon type shank). Roughing end mills are not recommended for use with HYDRAULIC CHUCKS. Do not tighten the clamping screw without first inserting a cutting tool into the tool holder. Always insert the cutting tool into the hydraulic tool holder beyond min. clamping length "E".

ACCESSORIES



CLAMPING RANGE: ϕ .250"-1.250" (ϕ 6-32mm)

For Drills, Reamers, Ball Mills, End Mills, Diamond Reamers & Grinding Tools

MAX
40,000
RPM

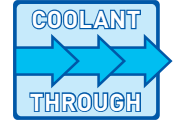

BBT/BT
A.2

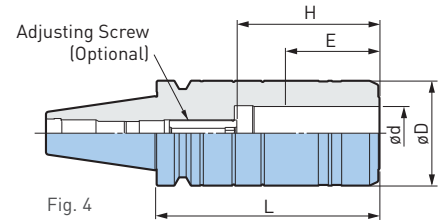
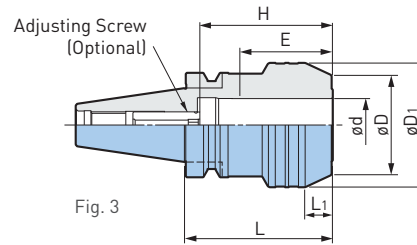
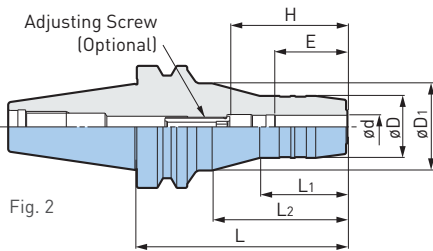
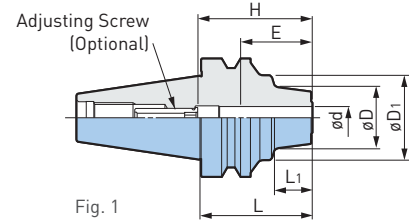

Catalog Number	Fig.	ϕd	ϕD	$\phi D1$	L	L1	L2	H	Min Clamping Length E	Adjusting Screw	Weight (lbs.)
BBT40-HDC.250-2.5	1	.250	1.024	1.77	2.50	.91	—	1.10-1.97	1.10	HDA6-05032	2.7
-4	4.00				1.73	2.44	3.3				
-5.5	5.50				3.94	4.0					
-HDC.375-2.5	1	.375	1.260	1.77	2.50	.94	—	1.30-2.17	1.30	HDA10-08032	2.9
-4	1.181		4.00		1.77	2.44	3.3				
-5.5	5.50		3.94		4.2						
-HDC.500-2.5	1	.500	1.299	1.77	2.50	.71	—	1.50-2.36	1.50	HDA12-10032	2.9
-4	4.00				1.81	2.44	3.6				
-5.5	5.50				3.94	4.2					
-HDC.625-3	1	.625	1.496	1.77	3.00	1.42	—	1.69-2.76	1.69	HDA16-12037	3.1
-4	4.00				1.85	2.40	3.6				
-5.5	5.50				3.90	4.2					
-HDC.750-3	2	.750	1.654	2.09	3.00	1.34	—	1.69-2.76	1.69	HDA16-12037	3.3
-4				1.97	4.00	1.85	2.44				3.8
-5.5				5.50	3.94	4.7					
-HDC1.000-3	2	1.000	2.165	2.48	3.00	.98	1.10	2.05-3.15	2.05	HDA25-16033	4.2
-5					5.00					HDA25-16039	6.4
-HDC1.250-3.5	3	1.250	2.953	—	3.50	.63	—	2.20-3.15	2.20	HDA25-16039	5.1
-5	4		2.480		5.00	—					6.2

Catalog Number	Fig.	ød	øD	øD1	L	L1	L2	H	Min Clamping Length E	Adjusting Screw	Weight (lbs.)
BBT40-HDC6-60	1	6mm	1.063	1.77	2.36	.75	—	1.10-1.97	1.10	HDA6-05032	2.7
-90	2		1.024		3.54	1.73	1.97				3.0
-110					4.33		2.76				3.3
-135					5.31		3.74				3.6
-165					6.50		4.69				4.2
-HDC8-60	1	8mm	1.142	1.77	2.36	.75	—	1.10-1.97	1.10	HDA8-06032	2.7
-90	2		1.102		3.54	1.73	1.97				3.0
-110					4.33		2.76				3.3
-135					5.31		3.74				3.8
-165					6.50		4.69				4.3
-HDC10-60	1	10mm	1.220	1.77	2.36	.79	—	1.30-2.17	1.30	HDA10-08032	2.7
-90	2		1.181		3.54	1.77	1.97				3.0
-110					4.33		2.76				3.3
-135					5.31		3.74				3.8
-165					6.50		4.69				4.3
-HDC12-60	1	12mm	1.299	1.77	2.36	.79	—	1.50-2.36	1.50	HDA12-10032	2.7
-90	2		1.260		3.54	1.77	1.93				3.0
-110					4.33		2.72				3.4
-135					5.31		3.70				3.9
-165					6.50		4.69				4.3
-HDC14-90	2	14mm	1.339	1.77	3.54	1.81	1.93	1.50-2.36	1.50	HDA12-10032	3.0
-110					4.33		2.72				3.4
-135					5.31		3.70				3.9
-HDC16-75	2	16mm	1.496	1.77	2.95	1.38	1.42	1.70-2.76	1.70	HDA16-16037	2.9
-90					3.54	1.85	1.93				3.1
-110					4.33		2.72				3.5
-135					5.31		3.70				4.1
-165			1.97	6.50	4.69	5.1					
-HDC18-90	2	18mm	1.575	1.77	3.54	1.89	1.93	1.70-2.76	1.70	HDA16-12037	3.2
-110					4.33		2.72				3.5
-135					5.31		3.70				4.1
-HDC20-90	2	20mm	1.654	1.77	3.54	1.89	1.97	1.70-2.76	1.70	HDA16-12037	3.1
-110				4.33	2.76		3.8				
-135			1.97	5.31	3.74		4.3				
-165			6.50	4.69	5.2						

• In case the projection length needs to be adjusted from the shank side, add the letter "W" to adjusting screw model number for hexagon sockets on both sides

ACCESSORIES



CAUTION

Use only cutting tools that have a shank tolerance of h6 (see table Pg. 26). Do not use with cutting tools made with a flat on the shank (ie: Weldon type shank). Roughing end mills are not recommended for use with HYDRAULIC CHUCKS. Do not tighten the clamping screw without first inserting a cutting tool into the tool holder. Always insert the cutting tool into the hydraulic tool holder beyond min. clamping length "E".

HIGH RIGIDITY TYPE

CLAMPING RANGE: $\varnothing 20\text{mm}$ - 32mm

Substantial body design to allow high-feed end milling, achieving highly reliable machining.

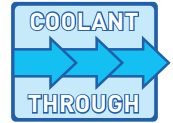

BBT/BT A.2

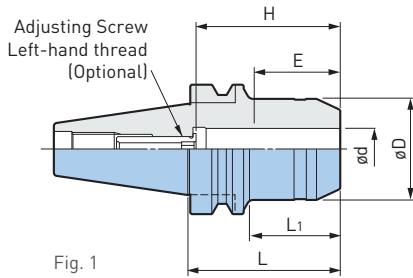

Fig. 1

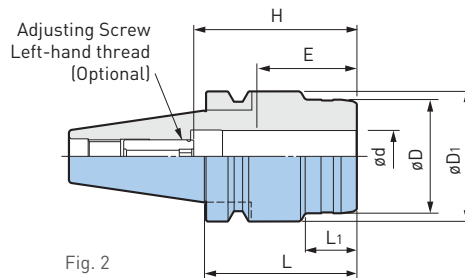

Fig. 2

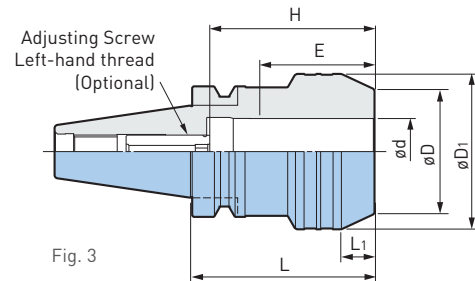

Fig. 3

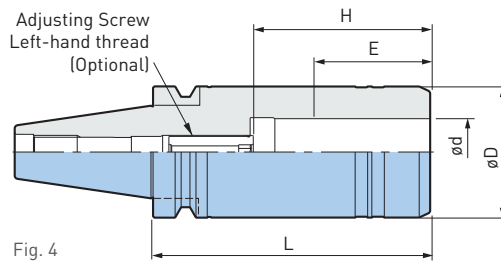

Fig. 4



Catalog Number	Fig.	$\varnothing d$	$\varnothing D$	$\varnothing D_1$	L	L ₁	H	Min Clamping Length E	Adjusting Screw	Weight (lbs.)
BBT40-HDC20E-75	1	20mm	1.929	—	2.95	1.77	1.70-2.76	1.70	HDA16-12037	3.1
-HDC25E-75	2	25mm	2.165	2.48	2.95	.98	2.05-3.15	2.05	HDA25-16033	4.0
-110					4.33					5.2
-135					5.31					6.5
-165					6.50					7.8
-HDC32E-90	3	32mm	2.362	2.95	3.54	.63	2.20-3.17	2.20	HDA25-16039	4.8
-110	4.33				5.6					
-135	5.31				6.2					
-165	2		2.480	—	5.31	—	2.20-3.35			7.1
				2.48	6.50					

- "H" indicates the adjustment length with an adjusting screw
- In case the projection length needs to be adjusted from the shank side, add the letter "W" to adjusting screw model number for hexagon sockets on both sides

ACCESSORIES



CAUTION

Use only cutting tools that have a shank tolerance of h6 (see table Pg. 26). Do not use with cutting tools made with a flat on the shank (ie: Weldon type shank). Roughing end mills are not recommended for use with HYDRAULIC CHUCKS. Do not tighten the clamping screw without first inserting a cutting tool into the tool holder. Always insert the cutting tool into the hydraulic tool holder beyond min. clamping length "E".

JET COOLANT TYPE

CLAMPING RANGE: \varnothing 4mm-32mm Coolant Holes Through Body of Holder

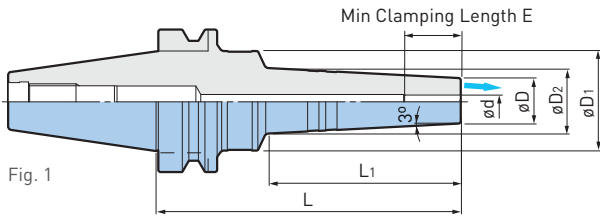
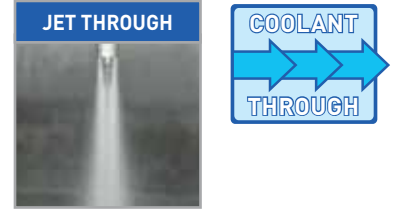

Fig. 1

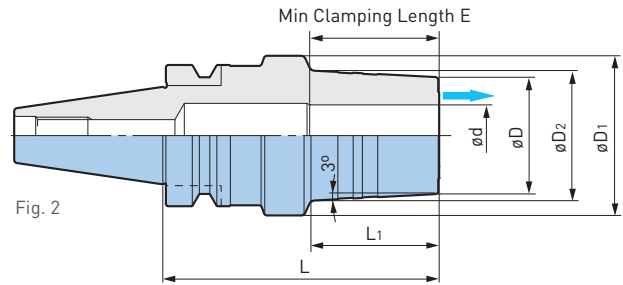

Fig. 2



Catalog Number	Fig.	$\varnothing d$	$\varnothing D$	$\varnothing D_1$	$\varnothing D_2$	L	L ₁	E	Weight (lbs.)					
BBT30-HDC4J-60	1	4mm	.787	1.81	.91	2.36	1.10	.75	1.3					
-HDC6J-90		6mm		1.65	1.02					1.97	.98	1.5		
-HDC8J-90		8mm	.866	1.10	1.26		1.18	1.5						
-HDC10J-90		10mm	.945	1.73					1.26				1.38	1.8
-HDC12J-90		12mm	1.024	1.81										
-HDC16J-90		16mm	1.339	1.57	1.57		1.65	2.0						
-HDC20J-90		20mm	1.496	2.05					1.69	1.57	2.4			
BBT40-HDC4J-90	1	4mm	.787	1.50	.98	3.54	1.77	.75	2.9					
-135				1.73	1.18	5.31	3.35		3.3					
-HDC6J-90		6mm	.787	1.50	.98	3.54	1.77	.98	2.9					
-135				1.73	1.14	5.31	3.35		3.3					
-HDC8J-90		8mm	.866	1.57	1.06	3.54	1.77	1.18	2.9					
-135				1.81	1.22	5.31	3.35		3.5					
-HDC10J-90		10mm	.945	1.65	1.14	3.54	1.77	1.26	2.9					
-135				1.89	1.30	5.31	3.35		3.5					
-HDC12J-90		12mm	1.024	1.73	1.22	3.54	1.77	1.38	2.9					
-135				1.97	1.38	5.31	3.35		3.7					
-HDC16J-90		16mm	1.339	1.81	1.57	3.54	1.81	1.65	3.1					
-135				1.97	1.73	5.31	3.50		4.2					
-HDC20J-90		20mm	1.496	1.89	1.73	3.54	1.85	1.65	3.3					
-135				2.09	1.89	5.31	3.54		4.4					
-HDC25J-90		25mm	2.008	2.48	2.20	3.54	1.61	1.93	4.2					
-HDC32J-90		2	32mm	2.322	2.95	—	3.54	.79	2.20	5.1				

• Adjusting screws cannot be used

CAUTION

Use only cutting tools that have a shank tolerance of h6. Do not use with cutting tools made with a flat on the shank (ie: Weldon type shank). Roughing end mills are not recommended for use with Hydraulic Chucks. Do not tighten the clamping screw without first inserting a cutting tool into the tool holder. Always insert the cutting tool into the hydraulic tool holder beyond min. clamping length "E".

SHRINK FIT HOLDER

CLAMPING RANGE: ϕ .250"-1.000" (ϕ 4-20mm)

BBT/BT A.2

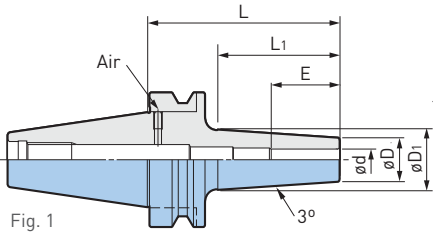

Fig. 1

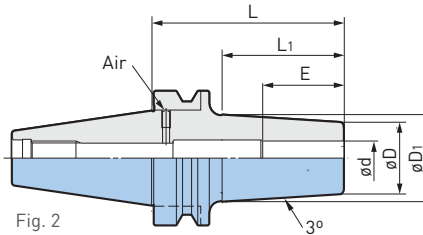

Fig. 2



Catalog Number	Fig.	ϕ d	ϕ D	ϕ D1	L	L1	H	E	Weight (lbs.)
BBT30-SRC4-75 ❖	1	4mm	.394	.57	2.95	1.73	—	.63	1.0
-SRC6-75		6mm	.551	.75		1.85		1.02	1.0
-SRC8-75		8mm	.709	.91		2.44		1.26	1.1
-SRC10-75	2	10mm	.866	1.06	2.95	1.85	2.83	1.26	1.2
-SRC12-75		12mm	.945	1.14				1.42	1.3
-SRC16-75		16mm	1.102	1.30				1.50	1.4
BBT40-SF.250-3.5	1	.250	.787	1.06	3.50	2.40	—	.87	2.6
-SF.375-3.5		.375	.945	1.26				1.22	2.7
-SF.500-3.5		.500	.945	1.26				1.42	2.7
-SF.625-3.5		.625	1.063	1.34				1.54	2.8
-SF.750-4	2	.750	1.299	1.65	4.00	2.90	—	1.85	3.2
-SF1.000-4		1.000	1.732	2.09				4.0	4.0
-SRC4-90 ❖	1	4mm	.394	.61	3.54	2.05	—	.63	2.3
-SRC6-90	1	6mm	.551	.79	3.54	2.24		2.4	
-150				1.02	4.49	2.8			
-SRC8-90		8mm	.709	.94	5.91	2.24	2.5		
-150	1.18			4.49	3.0				
-SRC10-90	10mm	.866	1.10	5.91	2.24	2.6			
-150			1.34	5.91	4.57	3.3			
-SRC12-90	12mm	1.102	1.18	3.54	2.24	2.6			
-150			1.42	5.91	4.57	3.4			
-SRC16-90	2	16mm	1.102	1.34	3.54	2.24	3.15	1.50	2.8
-165				1.65	6.50	5.20			4.0
-SRC20-90				20mm	1.339	1.57			3.54
-165	1.89	6.50	5.20			4.6			

- Use a carbide shank cutter within a tolerance of h6
- Use a carbide shank cutter within a tolerance of h5 with models marked ❖
- Center through coolant supply is available with tools with oil holes

CAUTION ⚠

Please refer to the operation manual of heating/cooling equipment, as some equipment may not be compatible.

SHRINK FIT HOLDER—SLIM TYPE CLAMPING RANGE: $\varnothing 6\text{mm}-12\text{mm}$

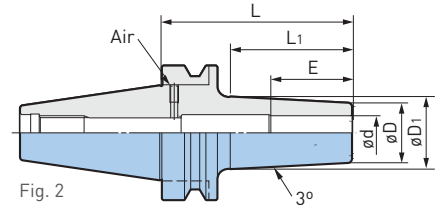
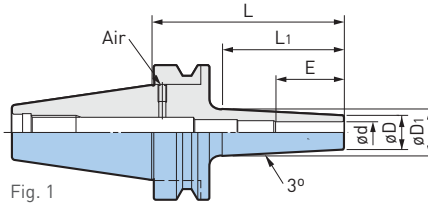
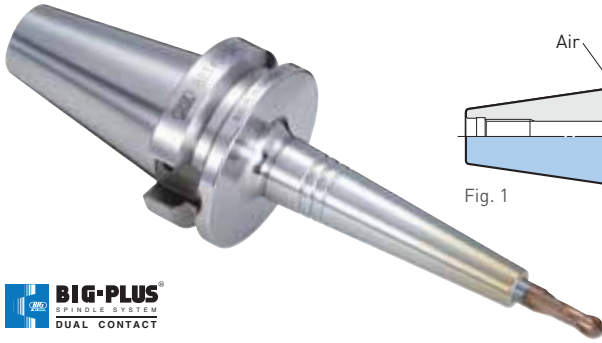

Catalog Number	Fig.	$\varnothing d$	$\varnothing D$	$\varnothing D_1$	L	L ₁	E	Weight (lbs.)
BBT30-SRC6S-105	1	6mm	.394	.71	4.13	3.03	1.02	1.1
-SRC8S-105		8mm	.512	.83				1.1
-SRC10S-105		10mm	.630	.94				1.2
-SRC12S-105	2	12mm	.748	1.06			1.42	1.3
BBT40-SRC6S-120	1	6mm	.394	.75	4.72	3.39	1.02	2.4
-165				.93	6.50	5.00		2.7
-SRC8S-120		8mm	.512	.87	4.72	3.39		2.5
-165				1.04	6.50	5.08		2.8
-SRC10S-120		10mm	.630	.98	4.72	3.39	1.26	2.6
-165				1.16	6.50	5.08		3.0
-SRC12S-120		12mm	.748	1.10	4.72	3.43	1.42	2.7
-165				1.30	6.50	5.16		3.2

- Use a carbide shank cutter within a tolerance of h6
- Center through coolant supply is available with tools with oil holes

CAUTION ⚠

Please refer to the operation manual of heating/cooling equipment, as some equipment may not be compatible.

JET THROUGH TYPE

Coolant is securely supplied to cutting edge periphery from chuck nose.

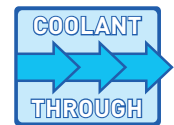
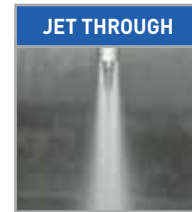
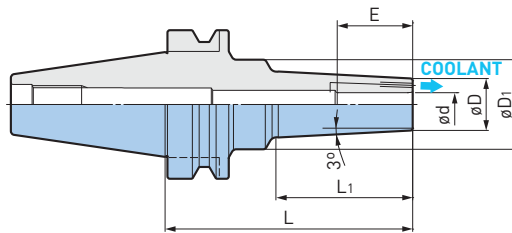

Catalog Number	$\varnothing d$	$\varnothing D$	$\varnothing D_1$	L	L ₁	E	Weight (lbs.)
BBT40-SRC6J-105	.236	.630	1.26	4.13	2.17	1.02	2.9
-SRC8J-105	.315	.748	1.38				2.9
-SRC10J-105	.394	.866	1.50		2.48	1.42	3.1
-SRC12J-105	.472	.945	1.57				3.1
BBT50-SRC6J-165	.236	.630	1.65	6.50	3.66	1.02	9.0
-SRC8J-165	.315	.748	1.77				9.3
-SRC10J-165	.394	.866	1.89		4.25	1.42	9.5
-SRC12J-165	.472	.945	1.97				9.5

- Use a carbide shank cutter within a tolerance of h6

CAUTION ⚠

Some shrink fit machines may not be compatible with the Shrink Chuck. Please refer to the shrink fit machine operation manual.

END MILL HOLDER

CLAMPING RANGE: ϕ .250"-1.250" (ϕ 6-32mm)

BBT/BT A.2

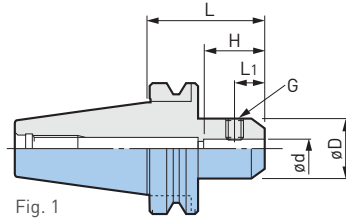

Fig. 1

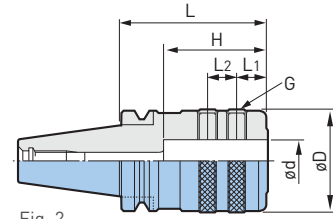

Fig. 2



Catalog Number	Fig.	ϕ d	ϕ D	L	L1	L2	H	G	Weight (lbs.)	
BBT30-EM.250-2.5	1	.250	.88	2.50	.44	—	1.10	1/4"-28	1.3	
-EM.375-2.5		.375	1.00		.75		1.77	3/8"-24	1.5	
-EM.500-2.5		.500	1.38		.87		3.00	7/16"-20	1.8	
-EM.625-2.5		.625	1.63		.94		2.69	9/16"-18	1.8	
-EM.750-3		.750	1.75	3.00	1.00		2.75	5/8"-18	1.8	
-ISL6-60		6mm	.98	2.36	.71		—	3.35	M6	1.3
-ISL8-60		8mm	1.10		M8				1.3	
-ISL10-60		10mm	1.38		.79			1.77	M10	1.5
-ISL12-60		12mm	1.65		.89			1.89	M12	1.8
-ISL16-60		16mm	1.89		.94			2.09	M14	1.8
BBT40-EM.500-3	1	.500	1.38		3.00	.87		—	3.00	7/16"-20
-EM.625-3		.625	1.63	.94		3.50	9/16"-18		2.9	
-EM.750-4		.750	1.75	1.00		3.88	5/8"-18		3.6	
-EM1.000-4	2	1.000	2.25	4.00	1.13	1.00	3.13	3/4"-16	4.5	
-EM1.250-4		1.250	2.75		1.13				5.6	
-ISL12-75	1	12mm	1.65	2.95	.89	—	4.33	M12	3.3	
-ISL16-75		16mm	1.89		.94		2.09	M14	3.3	
-ISL20-75		20mm	2.05		.98		2.17	M16	3.5	
-ISL25-90	2	25mm	2.50	3.54	.94	.98	2.36	M18 P2.0	4.6	
-ISL32-105		32mm	2.83	4.13	.94	1.10	3.23	M20 P2.0	6.4	

• For high speed applications MEGA DOUBLE POWER CHUCKS are recommended instead of End Mill Holders

ACCESSORIES



CAUTION

BIG genuine side lock screws must be used as they are made to an exclusive design and different from other screws on the market.

SIDE CUTTER ARBOR

CLAMPING RANGE: ϕ 1.000"-1.500"

Arbor for JIS Standard Side Cutters and Slitting Saws

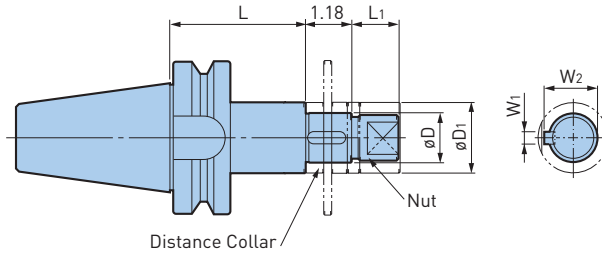

A.2
BBT/BT

Catalog Number	ϕ D (h6)	ϕ D1	W2	W1	L	L1	Weight (kg)
BBT40-SCA25.4-75	1.000	1.575	1.094	.250	2.95	.98	4.2
-120					4.72		5.1
-SCA31.75-75	1.250	1.811	1.375	.312	2.95	1.18	5.3
BBT50-SCA25.4-90	1.000	1.575	1.094	.250	3.54	.98	10.4
-135					5.31		11.2
-SCA31.75-90	1.250	1.811	1.375	.312	3.54	1.18	11.2
-135					5.31		12.6
-SCA38.1-90	1.500	2.165	1.656	.375	3.54	1.42	12.8
-135					5.31		15.0

- Nut is included
- Distance collars of 5mm, 8mm, 10mm and 12mm are included
- The model, dimensions and accuracy conform to TMT standards

DISTANCE COLLAR

For Side Cutter Arbor

Body Model	SCA25.4	SCA31.75	SCA38.1
Thickness	Distance Collar Model		
.197 (5mm)	SC254C5	SC3175C5	SC381C5
.315 (8mm)	SC254C8	SC3175C8	SC381C8
.394 (10mm)	SC254C10	SC3175C10	SC381C10
.472 (12mm)	SC254C12	SC3175C12	SC381C12

MORSE TAPER HOLDER

Precise finish of the Morse taper bore provides stable runout accuracy.

BBT/BT A.2

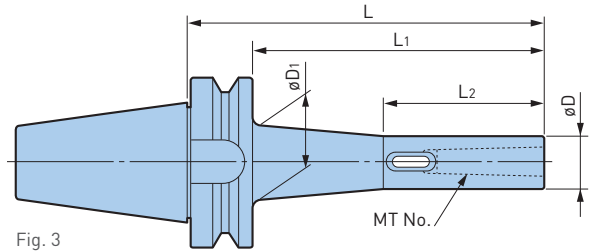
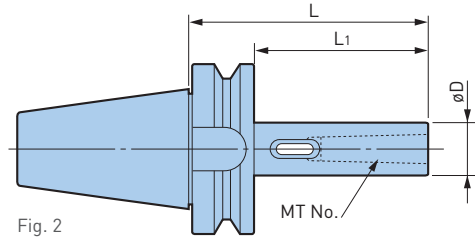
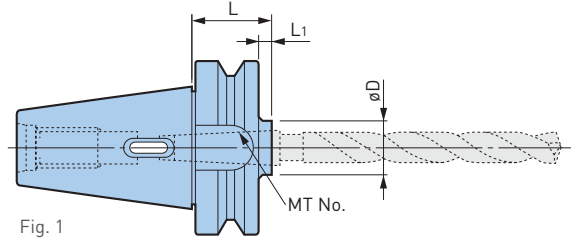

BIG-PLUS Taper Catalog Number	Standard Taper Catalog Number	Fig.	MT	øD	øD1	L	L1	L2	Weight (lbs.)	Reference Drill Dia. [JIS B4302 1]
BBT30-MTA1-60	BT30-MTA1-60	1	1	.984	—	2.36	1.50	—	1.1	.118-.551
-MTA2-60	-MTA2-60		2	1.260		2.36	1.50		1.2	.571-.906
-MTA3-80	-MTA3-80		3	1.575		3.15	2.28		1.6	.925-1.240
BBT40-MTA1-45	BT40-MTA1-45	1	1	.984	—	1.77	.71	—	2.2	.118-.551
-120	-120	2				4.72	3.66		2.9	
-MTA2-45	-MTA2-45	1	2	1.260	—	1.77	.71	—	2.2	.571-.906
-120	-120	2				4.72	3.66		3.5	
-MTA3-75	-MTA3-75	1	3	1.575	—	2.95	1.89	—	2.2	.925-1.240
-135	-135	2				5.31	4.25		3.7	
-MTA4-90	-MTA4-90	2	4	1.969	—	3.54	2.48	—	3.5	1.260-1.969
BBT50-MTA1-45	BT50-MTA1-45	1	1	.984	—	1.77	.28	—	8.6	.118-.551
-120	-120	2				4.72	3.23		9.3	
-180	-180					7.09	5.59		9.5	
-210	—	3	1.614	8.27	6.77	3.35	9.7			
-250	—		1.693	9.84	8.35		10.6			
-MTA2-45	-MTA2-45	1	2	1.260	—	1.77	.28	—	8.6	.571-.906
-135	-135	2				5.31	3.82		9.5	
-180	-180					7.09	5.59		10.1	
-210	—	3	1.791	8.27	6.77	3.74	10.6			
-250			1.909	9.84	8.35		11.5			
-300			1.949	11.81	10.31		12.8			

BIG-PLUS Taper Catalog Number	Standard Taper Catalog Number	Fig.	MT	øD	øD ₁	L	L ₁	L ₂	Weight (lbs.)	Reference Drill Dia. (JIS B4302 1)
BBT50-MTA3-45	BT50-MTA3-45	1	3	1.575	—	1.77	.28	—	8.4	.925-1.240
- 75	—					2.95	1.46		8.6	
-150	-150	2				5.91	4.41		10.1	
-180	-180					7.09	5.59		10.8	
-210	—	3				8.27	6.77		11.2	
-250					9.84	8.35	12.3			
-300			11.81	10.31	13.9					
-MTA4-75	-MTA4-75	1	4	1.969	—	2.95	1.46	—	8.6	1.260-1.969
-180	-180	2				7.09	5.59		11.9	
-210	—					8.27	6.77		12.3	
-250		9.84				8.35	13.7			
-300		11.81				10.31	15.4			
-MTA5-105	-MTA5-105	1			5	2.559	—	4.13	2.64	
-210	-210	2	8.27	6.77				15.9		

• The model, dimensions and accuracy conform to TMT standards

SHELL/FACE MILL HOLDER

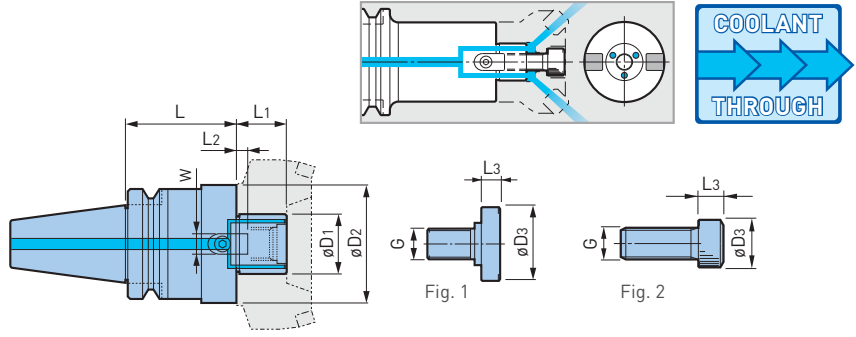

BBT/BT A.2

Catalog Number	Fig.	øD1	øD2	øD3	L	L1	L2	L3	W	G	Weight (lbs.)								
BBT30-SMC.750-2	1	.750	1.689	.88	2.00	.69	.16	.16	.313	3/8"-24	1.6								
-SMC1.000-2		1.000	2.189	1.12		.69	.22	.22	.375	1/2"-20	2.0								
-FMH16-37-35	2	16mm	1.457	—	1.38	.63	.20	—	.315	M8	1.2								
-FMH22-47-45●		22mm	1.850	—	1.77	.71	.20	.16	.394	M10	1.6								
-FMH27-60-45●		27mm	2.362	—	—	.79	.24	.22	.472	M12	2.0								
BBT40-SMC.750-2	1	.750	1.689	.88	2.00	.69	.16	.28	.313	3/8"-24	2.9								
-SMC1.000-2		1.000	2.189	1.12		.69	.22	.38	.375	1/2"-20	3.3								
-SMC1.250-2		1.250	2.752	1.50		.69	.28	—	.500	5/8"-18	4.0								
-SMC1.500-2		1.500	3.626	1.88		.93	.38	—	.625	3/4"-16	5.3								
-FMH22.225-47-60	2	22.225mm	1.850	—	2.36	.67	.14	—	.315	M10	3.3								
-90					3.54						4.2								
-FMH25.4-70-60●		25.4mm	2.756	—	2.36	.87	.20	—	.374	M12	4.4								
-90					3.54						5.9								
-105					4.13						6.8								
-FMH31.75-76-60●		31.75mm	2.992	—	2.36	1.18	.28	—	.500	M16	4.8								
-90					3.54						6.4								
-FMH31.75-96-60●		31.75mm	3.780	—	2.36	1.18	.28	—	.500	M16	5.5								
-FMH16-37-40		2	16mm	1.457	—	1.57	.63	.20	—	.315	M8	2.4							
-FMH22-47-45						22mm						1.850	—	1.77	.71	.20	—	.394	M10
-60	2.36													3.3					
-90	3.54													4.2					
-150	5.91		5.9																
-FMH22-60-45	22mm		2.362	—	1.77	.71	.20	—	.394	M10	3.3								
-60					2.36						4.0								
-90		3.54			5.5														
-FMH27-60-45	27mm	2.480	—	1.77	.79	.24	—	.472	M12	3.3									
-60				2.36						4.0									
-90				3.54						5.5									
-FMH27-76-60●	27mm	2.992	—	2.36	.79	.24	—	.472	M12	4.6									
-90				3.54						6.2									
-FMH32-96-60●	32mm	3.780	—	2.36	.87	.28	—	.551	M16	5.3									

- Cutter clamping screw is included
- The weight does not include the cutter
- If the provided clamping screw is not compatible, separately select one from the clamping screw table on Pg. 390
- When using a cutter without oil holes, an optional clamping screw with a through hole allows coolant supply
- øC indicates the smallest mounting surface diameter of the cutter that can be mounted on the arbor, be careful when using a cutter with the mounting diameter considerably smaller than the cutting diameter, as it may not fit
- The ATC arm interference zone K is 30mm for BBT30 and 45mm for BBT40 with models marked ●

ACCESSORIES



CAUTION ⚠

For high speed applications, Shell Mill Holders should be balanced together with the cutters.

SMART DAMPER MILLING—
FACE MILL ARBOR TYPE

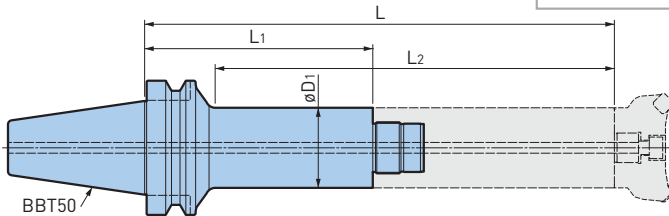
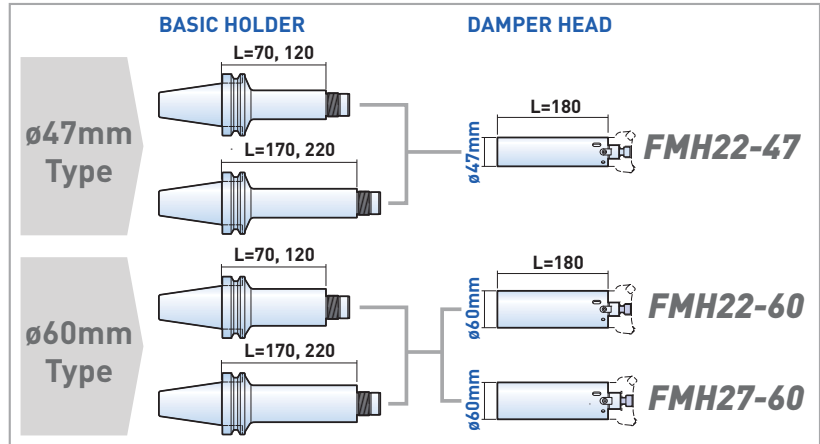
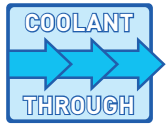

Catalog Number	ϕD_1	L	L1	L2	Weight (lbs.)	Damper Head Model
BBT50-SDF36-47-70	47mm	9.843	2.756	7.756	9.5	FMH□□DP-47
-47-120		11.811	4.724	9.724	11.0	
-47-170		13.780	6.693	11.693	12.3	
-47-220		15.748	8.661	13.661	13.9	
-60-70	60mm	9.843	2.756	7.756	10.1	FMH□□DP-60
-60-120		11.811	4.724	9.724	12.6	
-60-170		13.780	6.693	11.693	14.8	
-60-220		15.748	8.661	13.661	17.2	

SMART DAMPER MILLING—DAMPER HEAD

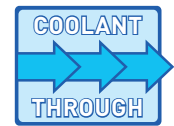
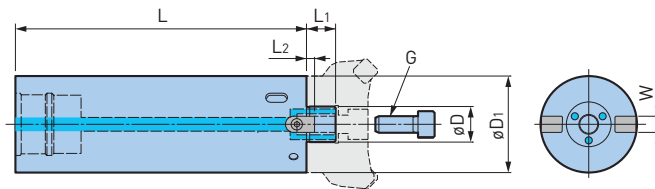

Catalog Number	ϕD	ϕD_1	L	L1	L2	W	G	Weight (lbs.)	C-Spanner Model
SDF36-FMH22DP-47-180	22mm	1.850	7.087	.709	.197	.394	M10	6.6	FK45-50L
-60-180	22mm	2.362	7.087	.709	.197	.394	M10	9.9	FK58-62L
-FMH27DP-60-180	27mm	2.362	7.087	.709	.236	.472	M12	9.9	
SDF36-SMC.750DP-47-180	.750	1.850	7.087	.689	.160	.313	3/8"-24	6.6	FK45-50L
-SMC1.000DP-60-180	1.000	2.362	7.087	.689	.220	.375	1/2"-20	9.9	FK58-62L

- Hook wrench and cutter clamping screw are included
- The weight does not include the cutter
- Refer to the operation manual regarding the mounting method to the basic holder
- If the provided clamping screw is not compatible, separately select one from the clamping screw table on Pg. 390
- ϕC indicates the smallest mounting surface diameter of the cutter that can be mounted on the arbor, be careful when using a cutter with the mounting diameter considerably smaller than the cutting diameter, as it may not fit

MEGA SYNCHRO TAPPING HOLDER

TAPPING RANGE: No.2-AU3/4 (M2-M20)

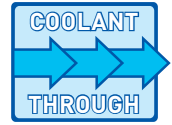
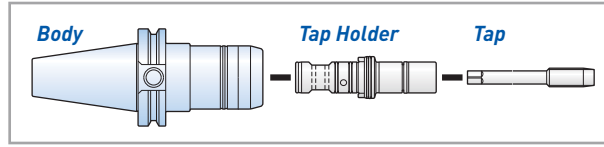

PATENT #
8226337

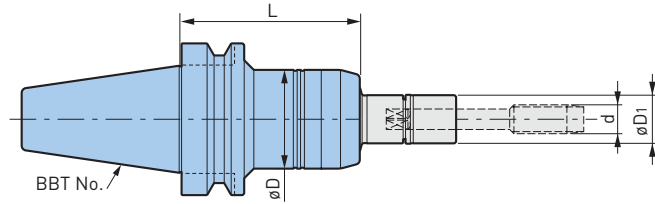

Catalog Number	Tapping Range d* (Inch)	Tapping Range d* (Metric)	øD	øD1	L	Wrench	Weight (lbs.)
BBT30-MGT6-70	No.2-No.12	M2-M6	1.42	.63	2.76	MGR16	1.5
-MGT12-70	AU1/4-AU7/16	M6-M12	1.61	.79	2.76	MGR20L	1.8
-MGT20-110	AU1/2-AU3/4 AP1/8-AP1/4	M12-M20	2.13	1.18	4.33	MGR30L	3.3
BBT40-MGT6-75	No.2-No.12	M2-M6	1.42	.63	2.95	MGR16	2.9
-MGT12-75	AU1/4-AU7/16	M6-M12	1.61	.79	2.95	MGR20L	3.1
-MGT20-95	AU1/2-AU3/4 AP1/8-AP1/4	M12-M20	2.13	1.18	3.74	MGR30L	4.0
BBT50-MGT6-90	No.2-No.12	M2-M6	1.42	.63	3.54	MGR16	8.6
-MGT12-90	AU1/4-AU7/16	M6-M12	1.61	.79	3.54	MGR20L	8.8
-MGT20-105	AU1/2-AU3/4 AP1/8-AP1/4	M12-M20	2.13	1.18	4.13	MGR30L	9.7

*AU3/8 is included in the MGT20 series

- MGT set screw is included, tap holder and wrench must be ordered separately

ACCESSORIES



CAUTION

Cannot be used with machining center without synchronized tapping function.

MEGA SYNCHRO TAPPING HOLDER

TAPPING RANGE: No.0-No.6 (M1-M3)

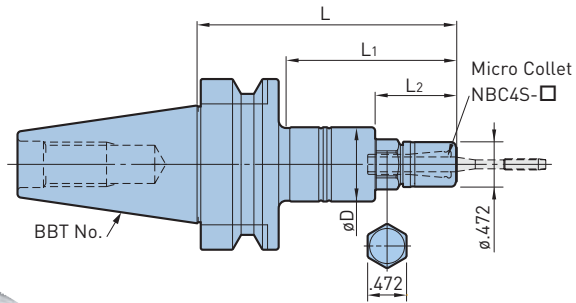

Catalog Number	Tapping Range d* (Inch)	Tapping Range d* (Metric)	ϕD	L	L1	L2	Wrench	Weight (lbs.)
BBT30-MGT3-70	No.0-No.6	M1-M3	.787	2.76	1.81	.87	MGR12	1.5
BBT40-MGT3-90	No.0-No.6	M1-M3	.787	3.54	2.40	.87	MGR12	2.6

- Nut is included, collet and wrench must be ordered separately
- When attaching or detaching the tap, a commercially available flat wrench (12mm width) is also required
- Not capable of supplying coolant through the holder body

ACCESSORIES



CAUTION

Cannot be used with machining center without synchronized tapping function.

TAPPING RANGE: AU13/16-AU1-1/2 (M20-M36)

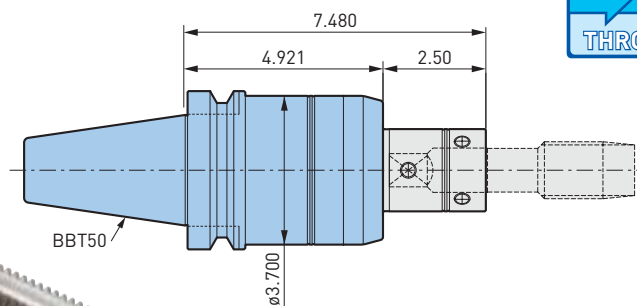

Catalog Number	Tapping Range d (Inch)	Tapping Range d (Metric)	Weight (lbs.)
BBT50-MGT36-125	AU13/16-AU1-1/2 AP3/8-AP1	M20-M36	15.8

- MGT set screw is included, tap holder must be ordered separately

ACCESSORIES



CAUTION

Cannot be used with machining center without synchronized tapping function.

CKB SHANKS

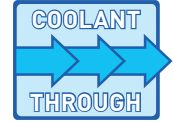

BBT/BT A.2

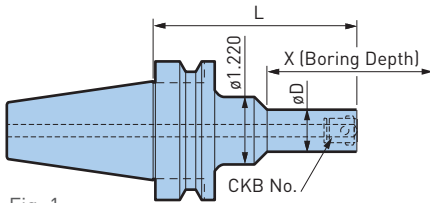

Fig. 1

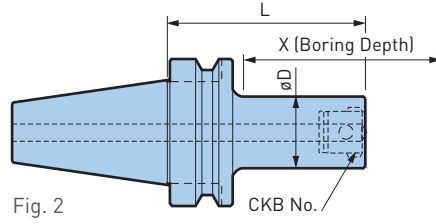

Fig. 2

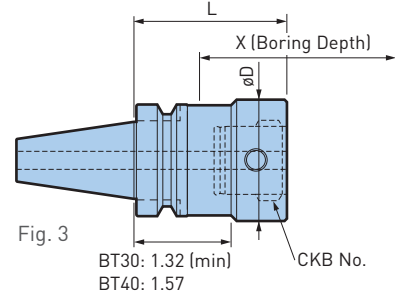

Fig. 3

Catalog Number	Reference Number	Fig.	CK	øD	L	X	Weight (lbs.)
BT30-CKB1-72	—	1	CKB1	.748	2.835	2.874	1.1
-CKB2-38	—	2	CKB2	.945	1.476	1.890	.7
-83	—				3.248	3.661	1.3
-CKB3-39	—	2	CKB3	1.220	1.535	2.087	1.0
-79	—				3.110	3.661	1.5
-CKB4-38	—	2	CKB4	1.535	1.496	2.283	1.0
-73	—				2.874	3.661	1.7
-CKB5-38	10.329.866	3	CKB5	1.968	1.496	2.677	1.0
-63	—				2.480	3.661	1.8
-CKB6-64	—	3	CKB6	2.520	2.520	3.661	2.9
BT40-CKB1-72	—	2	CKB1	.748	2.835	2.874	2.4
-CKB2-43	—	2	CKB2	.945	1.673	1.890	2.2
-83	—				3.248	3.465	2.6
-CKB3-44	—	2	CKB3	1.220	1.732	2.087	2.4
-94	—				3.701	4.055	2.9
-CKB4-43	—	2	CKB4	1.535	1.693	2.283	2.6
-65	10.326.141	2			2.559	3.150	3.0
-88	—	2			3.465	4.055	3.3
-CKB5-48	—	2	CKB5	1.968	1.890	2.874	2.6
-55	10.326.151	2			2.165	3.150	3.0
-78	—	2			3.071	4.055	3.5
-CKB6-46	10.326.161	3	CKB6	2.500	1.811	3.346	2.5
-64	—	3		2.520	2.520	4.055	3.5

Catalog Number	Reference Number	Fig.	CK	øD	L	X	Weight (lbs.)
BT50-CKB1-102	—	1	CKB1	.748	4.016	2.874	8.8
-CKB2-53	—	2	CKB2	.945	2.067	1.850	8.4
-113	—				4.429	4.213	8.8
-CKB3-54	—	2	CKB3	1.220	2.126	2.047	8.6
-124	—				4.882	4.803	9.5
-CKB4-58	—	2	CKB4	1.535	2.283	2.441	9.5
-118	—				4.646	4.803	9.9
-178	—				7.008	7.165	10.8
-CKB5-63	—	2	CKB5	1.968	2.480	3.031	8.8
-86	10.326.352				3.386	3.937	9.5
-108	—				4.252	4.803	10.3
-183	—				7.205	7.756	13.0
-228	—				8.976	9.528	14.3
-CKB6-72	10.326.362	2	CKB6	2.500	2.835	3.937	9.2
-94	—				3.701	4.803	10.6
-169	—				6.654	7.756	14.7
-229	—				9.016	10.118	18.0
-CKB7-86	10.326.374	2	CKB7	3.543	3.386	6.299	11.7
-93	—				3.661	6.772	12.3
-183	—				7.205	10.315	21.8
-243	—				9.567	12.677	28.0

- X dimensions on the table are reference figures when EWN/EWE head is mounted
- Cutting edge and drive key grooves are located in the same orientation

CKN SHANKS

Catalog Number	Reference Number	CK	Fig.	øD	L	X	Weight (lbs.)
BT40-CKN6-46	10.323.735N	CKN6	2	2.500	1.811	3.346	2.2
-61	10.323.736N		2	2.500	2.402	3.937	2.9
BT50-CKN6-72	10.323.775N	CKN6	1	2.500	2.835	3.937	8.6
-CKN7-86	10.323.776N	CKN7	2	3.543	3.386	6.299	10.9

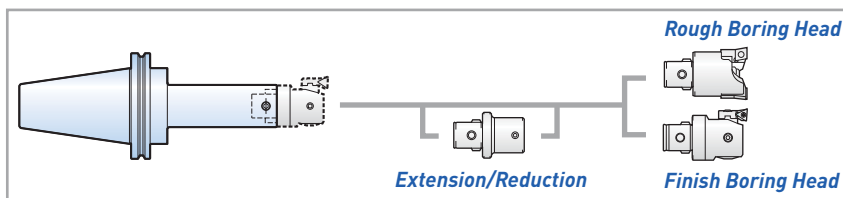

CKB SHANKS—BIG-PLUS

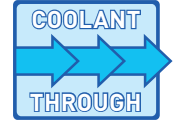

BBT/BT A.2

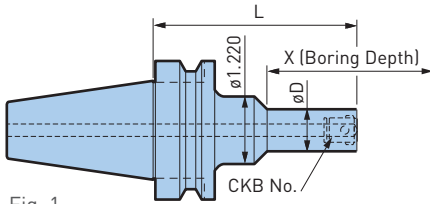

Fig. 1

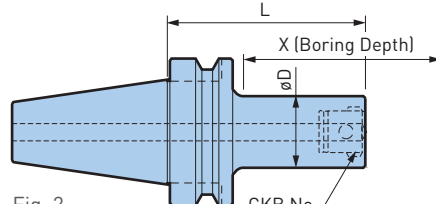

Fig. 2

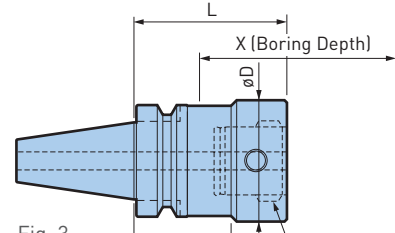

Fig. 3

BBT30: 1.32 (min)
BBT40: 1.57



Catalog Number	Fig.	CK	øD	L	X	Weight (lbs.)	
BBT30-CKB1-72	1	CKB1	.748	2.835	2.874	1.1	
-CKB2-38	2	CKB2	.945	1.476	1.890	.7	
-83				3.248	3.661	1.3	
-CKB3-39		CKB3	1.22	1.535	2.087	1.0	
-79				3.110	3.661	1.5	
-CKB4-38		CKB4	1.535	1.496	2.283	1.0	
-73				2.874	3.661	1.7	
-CKB5-63	3	CKB5	1.968	2.480	3.661	1.8	
-CKB6-64		CKB6	2.520	2.520	3.661	2.9	
BBT40-CKB1-72	2	CKB1	.748	2.835	2.874	2.4	
-CKB2-43		CKB2	.945	1.673	1.890	2.2	
-83				3.248	3.465	2.6	
-CKB3-44		CKB3	1.220	1.732	2.087	2.4	
-94				3.701	4.055	2.9	
-124		4.882	4.449	3.3			
-CKB4-43		CKB4	1.535	1.693	2.283	2.6	
-88				3.465	4.055	3.3	
-118				4.646	5.236	4.0	
-148				5.827	6.417	4.6	
-CKB5-48		CKB5	1.968	1.890	2.874	2.6	
-78				3.071	4.055	3.5	
-108				4.252	5.236	4.6	
-138				5.433	6.417	5.5	
-CKB6-64		3	CKB6	2.520	2.520	4.055	3.5
-94					3.701	5.236	5.1
-124					4.882	6.417	6.9

Catalog Number	Fig.	CK	øD	L	X	Weight (lbs.)
BBT50-CKB1-102	1	CKB1	.748	4.016	2.874	8.8
-CKB2-53		CKB2	.945	2.067	1.850	8.4
-113	4.429			4.213	8.8	
-CKB3-54	2	CKB3	1.220	2.126	2.047	8.6
-124				4.882	4.803	9.5
-CKB4-58	2	CKB4	1.535	2.283	2.441	9.5
-118				4.646	4.803	9.9
-178				7.008	7.165	10.8
-208				8.189	8.346	11.2
-CKB5-63				CKB5	1.968	2.480
-108	4.252	4.803	10.3			
-183	7.205	7.756	13.0			
-228	8.976	9.528	14.3			
-263	10.354	10.906	15.4			
-CKB6-94	2	CKB6	2.491	3.701	4.803	10.6
-169				6.654	7.756	14.7
-229		2.520	9.016	10.118	18.0	
-289			11.378	12.480	21.3	
-CKB7-93	2	CKB7	3.543	3.661	6.772	12.3
-183				7.205	10.315	21.8
-243				9.567	12.677	28.0

- X dimensions on the table are reference figures when EWN/EWE head is mounted
- Cutting edge and drive key grooves are located in the same orientation

CKN SHANKS

Catalog Number	Reference Number	Fig.	CK	øD	L	X	Weight (lbs.)
BBT40-CKN6-46	10.323.832N	2	CKN6	2.500	1.811	3.346	2.2
-61	10.323.831N	2		2.500	2.402	3.937	2.9
BBT50-CKN6-72	10.323.874N	1	CKN6	2.500	2.835	3.937	8.7
-CKN7-86	10.323.871N	2	CKN7	3.543	3.386	6.299	10.8

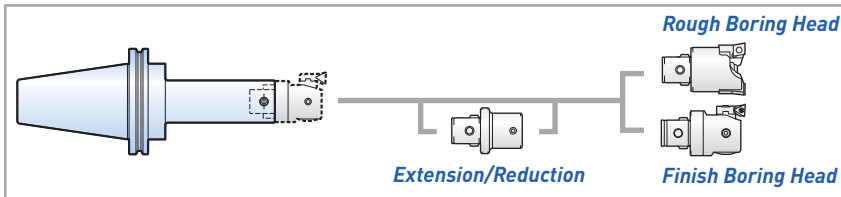

BIG CAPTO SHANKS

BBT/BT A.2

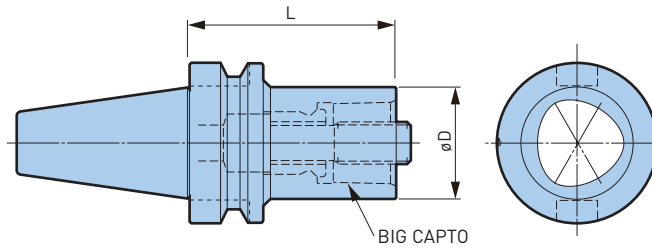

Catalog Number	BIG CAPTO	øD	L	Weight (lbs.)
BBT40-C3-30	C3	1.260	1.181	2.2
-C4-40	C4	1.575	1.575	2.4
-C5-50	C5	1.969	1.969	4.9
-C6-75	C6	2.480	2.953	3.7
BBT50-C3-30	C3	1.260	1.575	7.9
-C4-40	C4	1.575		7.9
-C5-40	C5	1.969		7.7
-C6-50	C6	2.480		7.7
-C8-70	C8	3.150	2.756	8.8

• Clamp bolt is included

BIG KOMET ABS SHANKS

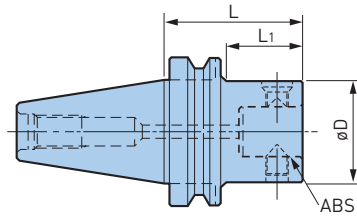

Catalog Number	ABS	øD	L	L1	Weight (lbs.)
BBT40-ABS40-60	ABS40	1.575	2.362	1.22	2.9
-ABS50-60	ABS50	1.969			3.1
-ABS63-70	ABS63	2.480	2.756	1.69	4.0
BBT50-ABS50-70	ABS50	1.969	2.756	.945	9.0
-ABS63-80	ABS63	2.480	3.150	1.46	9.9
-ABS80-100	ABS80	3.150	3.937	2.36	12.5
-ABS100-110	ABS100	3.937	4.331	2.84	15.4

- Clamp bolt is included

AG90 NBS TYPE

CLAMPING RANGE: \varnothing .010"-.787"

MAX
6,000
RPM

BBT/BT
A.2

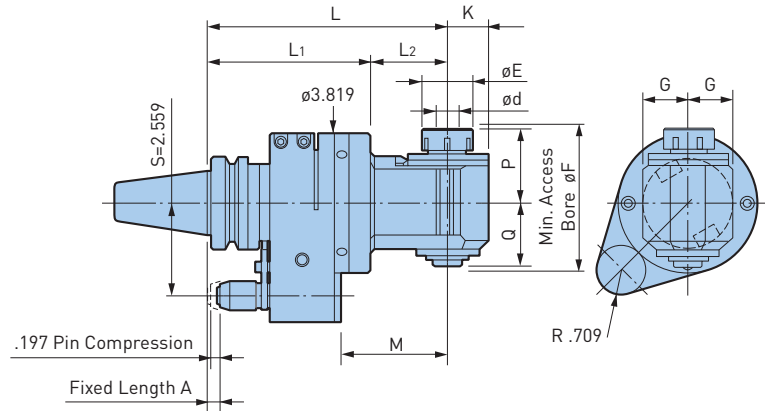

BIG-PLUS
SPINDLE SYSTEM
DUAL CONTACT

Catalog Number	$\varnothing d$	$\varnothing E$	G	K	L	L1	L2	M	P	Q	$\varnothing F$	Collet	Max RPM	Weight (lbs.)
BBT40-AG90/NBS6-170	.010-.236	.787	.827	.669	6.69	4.53	2.17	3.03	1.30	1.14	2.638	NBC6	6,000	11.2
-200					7.87		3.35	4.21						11.7
-230					9.06		4.53	5.39						12.1
-260					10.24		5.71	6.58						12.5
-AG90/NBS10-170	.059-.394	1.181	1.181	.984	6.69	4.53	2.17	3.03	1.77	1.69	3.583	NBC10	6,000	12.1
-200					7.87		3.35	4.21						13.0
-230					9.06		4.53	5.39						13.7
-AG90/NBS13-170	.098-.512	1.378	1.220	1.102	6.69	4.53	2.17	3.03	2.05	1.77	3.976	NBC13	6,000	12.3
-200					7.87		3.35	4.21						13.2
-230					9.06		4.53	5.39						13.9
-AG90/NBS20S-165S	.098-.787	1.811	1.378	1.299	6.50	4.41	2.09	2.84	2.56	2.44	5.197	NBC20	3,000	17.6

- Nut and wrench are included, collet must be ordered separately
- The angles of the locating pin to the drive key groove and direction of cutting edge are freely adjustable
- A stop block is required when mounting on machines must be order separately
- When supplied through the stop block, coolant can be ejected from the housing
- Automatic tool change may not be available depending on machine tool models
- NEW BABY ENDMILL COLLETS cannot be used

ACCESSORIES



CAUTION

A Stop Block is required. The rotation of the cutting tool is in reverse direction of the machine spindle (Speed Ratio 1:1).

AG90 NBS TYPE

CLAMPING RANGE: ϕ .010"-.787"

MAX
6,000
RPM

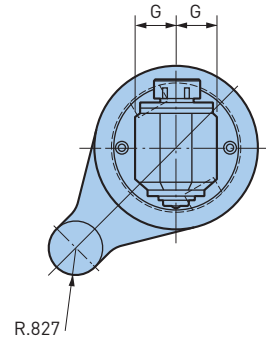
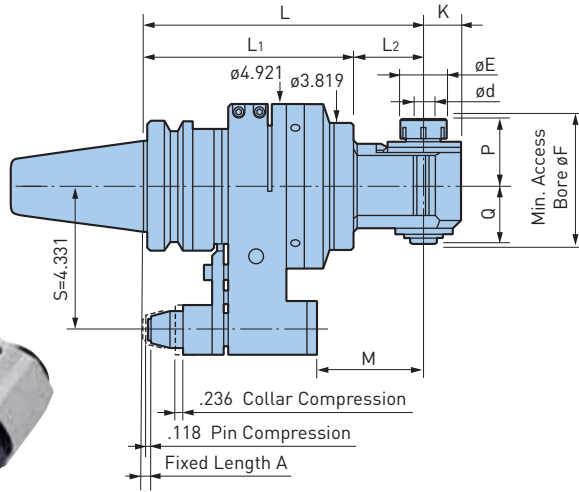

BIG-PLUS[®]
SPINDLE SYSTEM
DUAL CONTACT

A.2
BBT/BT

Catalog Number	ϕd	ϕE	G	K	L	L1	L2	M	P	Q	ϕF	Collet	Max RPM	Weight (lbs.)
BBT50-AG90/NBS6-215	.010-.236	.787	.827	.669	8.47	6.30	2.17	3.23	1.30	1.14	2.638	NBC6	6,000	27.8
-245					9.65		3.35	4.41						28.2
-275					10.83		4.53	5.59						28.7
-305					12.01		5.71	6.77						29.1
-AG90/NBS10-215	.059-.394	1.181	1.181	.984	8.47	6.30	2.17	3.23	1.77	1.69	3.583	NBC10	6,000	28.7
-245					9.45		3.35	4.41						29.5
-275					10.83		4.53	5.59						30.2
-AG90/NBS13-215	.098-.512	1.378	1.220	1.102	8.47	6.30	2.17	3.23	2.05	1.77	3.976	NBC13	6,000	28.9
-245					9.45		3.35	4.41						29.8
-275					10.83		4.53	5.59						30.4
-AG90/NBS20-230	.098-.787	1.811	1.378	1.378	9.06	6.30	2.76	3.82	2.56	2.44	5.197	NBC20	3,000	31.3

- Nut and wrench are included, collet must be ordered separately
- The angles of the locating pin to the drive key groove and direction of cutting edge are freely adjustable
- A stop block is required when mounting on machines must be order separately
- When supplied through the stop block, coolant can be ejected from the housing
- Automatic tool change may not be available depending on machine tool models
- NEW BABY ENDMILL COLLETS cannot be used

ACCESSORIES



CAUTION

A Stop Block is required. The rotation of the cutting tool is in reverse direction of the machine spindle (Speed Ratio 1:1).

AG90 NBS EXTRA LONG TYPE

CLAMPING RANGE: ϕ .010"-.787"

For Drilling & Key Slotting in Deep Holes of Large Workpieces

MAX
6,000
RPM

BBT/BT
A.2

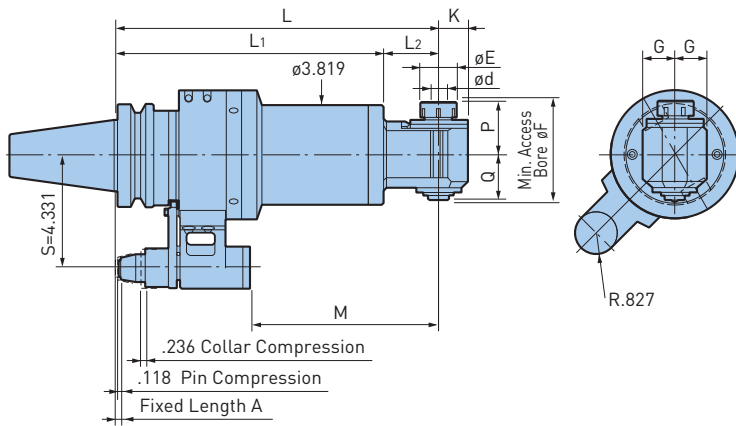

Catalog Number	ϕ d	ϕ E	G	K	L	L1	L2	M	P	Q	ϕ F	Collet	Max RPM	Weight (lbs.)
BBT50-AG90NBS6-315LS	.010-.236	.787	.827	.669	12.40	10.24	2.17	7.17	1.30	1.14	2.638	NBC6-□	6,000	41.7
-345LS					13.58		3.35	8.35						42.1
-375LS					14.76		4.53	9.53						42.5
-405LS					15.94	5.71	10.71	43.0						
-415LS					16.34	2.17	11.10	51.4						
-445LS					17.52	14.17	3.35	12.28						51.8
-475LS					18.70	4.53	13.46	52.2						
-505LS					19.88	5.71	14.65	52.7						
-515LS					20.28	2.17	15.04	61.1						
-545LS					21.46	18.11	3.35	16.22						61.5
-575LS					22.64	4.53	17.40	61.9						
-605LS					23.82	5.71	18.58	62.4						

Catalog Number	ød	øE	G	K	L	L1	L2	M	P	Q	øF	Collet	Max RPM	Weight (lbs.)
BBT50-AG90/NBS10-315LS	.059-.394	1.181	1.181	.984	12.40	10.24	2.17	7.17	1.77	1.69	3.583	NBC10-□	6,000	42.5
-345LS					13.58		3.35	8.35						43.4
-375LS					14.76		4.53	9.53						44.1
-415LS					16.34	2.17	11.10	52.2						
-445LS					17.52	14.17	3.35	12.28						53.1
-475LS					18.70	4.53	13.46	53.8						
-515LS					20.28	2.17	15.04	61.9						
-545LS					21.46	18.11	3.35	16.22						62.8
-575LS					22.64	4.53	17.40	63.5						
-AG90/NBS13-315LS					.098-.512	1.378	1.220	1.102						12.40
-345LS	13.58	3.35	8.35	43.7										
-375LS	14.76	6.10	9.53	44.3										
-415LS	16.34	2.17	11.10	52.5										
-445LS	17.52	14.17	3.35	12.28					53.4					
-475LS	18.70	6.10	13.46	54.0										
-515LS	20.28	2.17	15.04	62.2										
-545LS	21.46	18.11	3.35	16.22					63.1					
-575LS	22.64	6.10	17.40	63.7										
-AG90/NBS20-330LS	.098-.787	1.811	1.378	1.378					12.99	10.24	2.76	7.76	2.56	2.44
-430LS					16.93	14.17	2.76	11.69	54.9					
-530LS					20.87	18.11	2.76	15.63	64.6					

- Nut and wrench are included, collet must be ordered separately
- Output spindles of twin head do not rotate in forward direction simultaneously
- The angles of the locating pin to the drive key groove and direction of cutting edge are freely adjustable
- A stop block is required when mounting on machines must be order separately
- When supplied through the stop block, coolant can be ejected from the housing
- Automatic tool change may not be available depending on machine tool models
- NEW BABY ENDMILL COLLETS cannot be used

ACCESSORIES



CAUTION ⚠

A Stop Block is required. The rotation of the cutting tool is in reverse direction of the machine spindle (Speed Ratio 1:1).

AG90 COMPACT TYPE

CLAMPING RANGE: ϕ .098"-.512"

For Drilling Only—Ideal Size for Small Machining Centers

MAX
5,000
RPM

BBT/BT A.2

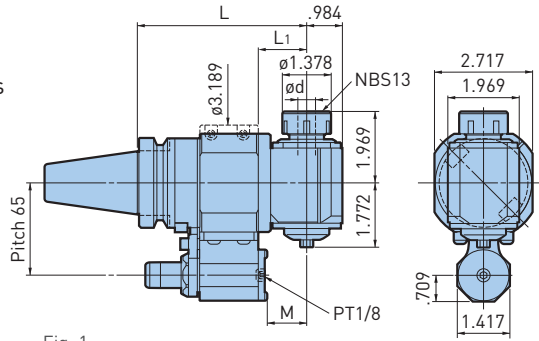

Fig. 1

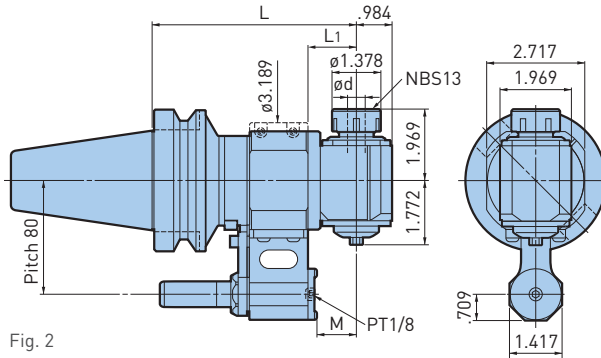

Fig. 2



Catalog Number	Fig.	ϕ d	L	L ₁	M	Collet	Speed Ratio	Weight (lbs.)
BBT40-AG90-13-120	1	.098-.512	4.72	3.39	1.10	NBC13	1:1	9.9
-170			6.70	3.31	3.06			12.1
BBT50-AG90-13-145	2	.098-.512	5.71	1.34	1.10	NBC13	1:1	16.8
-195			7.68	3.31	3.06			19.0

- Nut and wrench are included, collet must be ordered separately
- The angles of the locating pin to the drive key groove and direction of cutting edge are freely adjustable
- A stop block is required when mounting on machines must be order separately
- A tapped hole (PT1/8) is prepared at the bottom cover of the Locating Pin housing so that a pipe for coolant can be connected
- Automatic tool change may not be available depending on machine tool models
- NEW BABY ENDMILL COLLETS cannot be used

ACCESSORIES



CAUTION

A Stop Block is required. The rotation of the cutting tool is in reverse direction of the machine spindle (Speed Ratio 1:1). AG90 Compact Type is for drilling only.

APPLICATION EXAMPLE



Stable machining is obtained due to high rigidity and good runout.

DRILLING	
Cutter	ϕ .472" (12mm) Carbide Drill
Workpiece	1050 Steel
Cutting Speed	230 SFM
Cutting Feed	14.6 IPM
	.008 IPR
Spindle Speed	1,860 RPM

AG90 SLENDER DRIVE

CLAMPING RANGE: ϕ .118"-.236" For Angular Operations Within a ϕ 1.181 Inch Bore

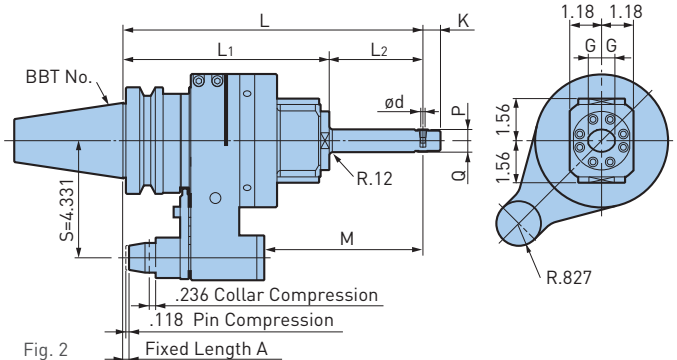
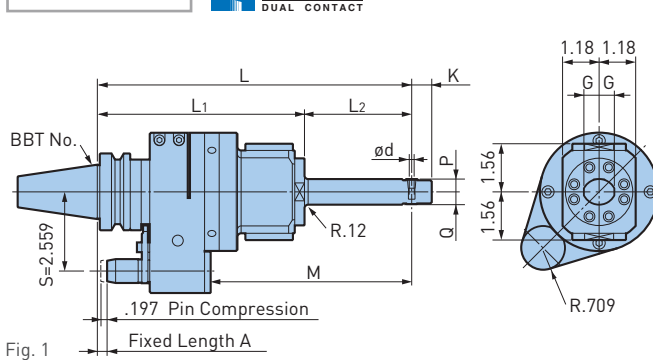
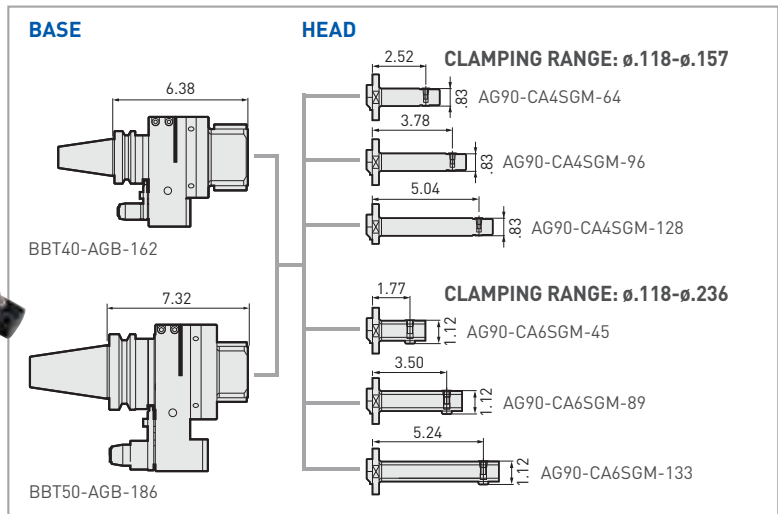

Base	Head	Fig.	ϕd	G	K	L	L1	L2	M	P	Q	Speed Ratio	Weight (lbs.)
BBT40-AGB-162	AG90-CA4SGM-64	1	.118-.157	.492	.650	8.90	6.69	2.21	5.24	.41	.41	1:1.06 (Increase)	12.3
	-96					10.16		3.47	6.50				12.6
	-128					11.42		4.72	7.76				12.9
	AG90-CA6SGM-45	1	.118-.236	.591	.787	8.15	6.69	1.46	4.49	.49	.63	1:0.77 (Decrease)	12.6
	-89					9.88		3.19	6.22				13.0
	-133					11.61		4.92	7.95				13.5
BBT50-AGB-186	AG90-CA4SGM-64	2	.118-.157	.492	.650	9.84	7.64	2.21	4.61	.41	.41	1:1.06 (Increase)	26.2
	-96					11.10		3.47	5.87				26.5
	-128					12.36		4.72	7.13				26.7
	AG90-CA6SGM-45	2	.118-.236	.591	.787	9.09	7.64	1.46	3.86	.49	.63	1:0.77 (Decrease)	26.5
	-89					10.83		3.19	5.59				26.9
	-133					12.56		4.92	7.32				27.3

- Collet must be ordered separately
- The angles of the locating pin to the drive key groove and direction of cutting edge are freely adjustable
- A stop block is required when mounting on machines must be order separately

ACCESSORIES



CAUTION

A Stop Block is required. The rotation of the cutting tool is in same direction of the machine spindle.

AG90 BUILD-UP TYPE

For All Kinds of Machinery Applications

BBT/BT A.2

MAX
3,000
RPM

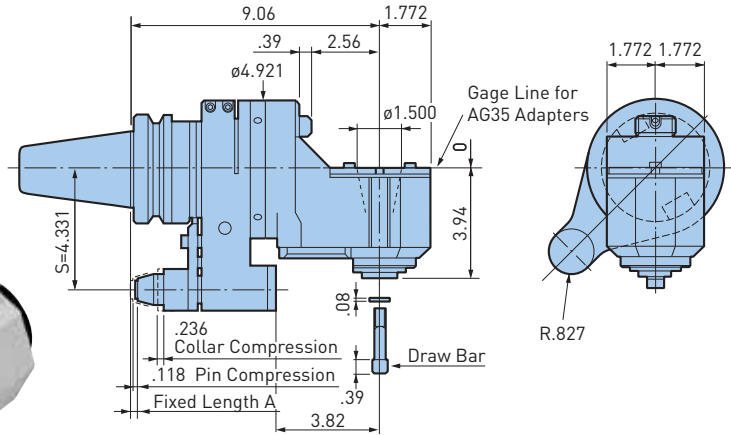

CAUTION

A Stop Block is required. The rotation of the cutting tool is in same direction of the machine spindle.

Catalog Number	Weight (lbs.)
BBT50-AG90/AGH35-230	33.1

- The angles of the locating pin to the drive key groove and direction of cutting edge are freely adjustable
- A stop block is required when mounting on machines must be order separately
- When supplied through the stop block, coolant can be ejected from the housing
- Automatic tool change may not be available depending on machine tool models

For Application Where Increased Rigidity is Required

MAX
3,000
RPM

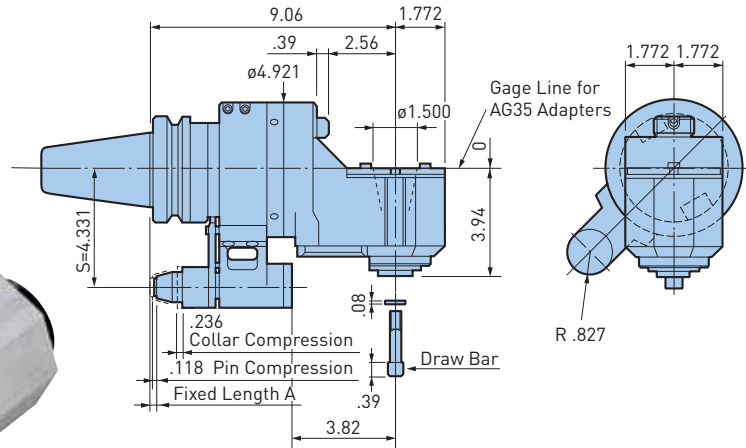

CAUTION

A Stop Block is required. The rotation of the cutting tool is in same direction of the machine spindle.

Catalog Number	Weight (lbs.)
BBT50-AG90/AGH35-230S	35.9

- The angles of the locating pin to the drive key groove and direction of cutting edge are freely adjustable
- A stop block is required when mounting on machines must be order separately
- When supplied through the stop block, coolant can be ejected from the housing
- Automatic tool change may not be available depending on machine tool models

ACCESSORIES



AG90 HMC TYPE

For Heavy Duty End Milling

MAX
3,000
RPM

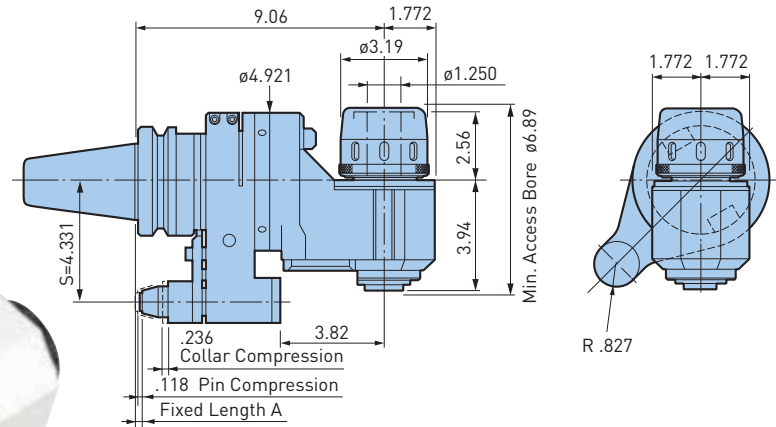

A.2
BBT/BT



Catalog Number	Weight (lbs.)
BBT50-AG90/HMC1.250-230	37.0

CAUTION

A Stop Block is required. The rotation of the cutting tool is in same direction of the machine spindle.

- Wrench is included
- The angles of the locating pin to the drive key groove and direction of cutting edge are freely adjustable
- A stop block is required when mounting on machines must be order separately
- When supplied through the stop block, coolant can be ejected from the housing
- Automatic tool change may not be available depending on machine tool models

For Applications Where Increased Rigidity is Required

MAX
3,000
RPM

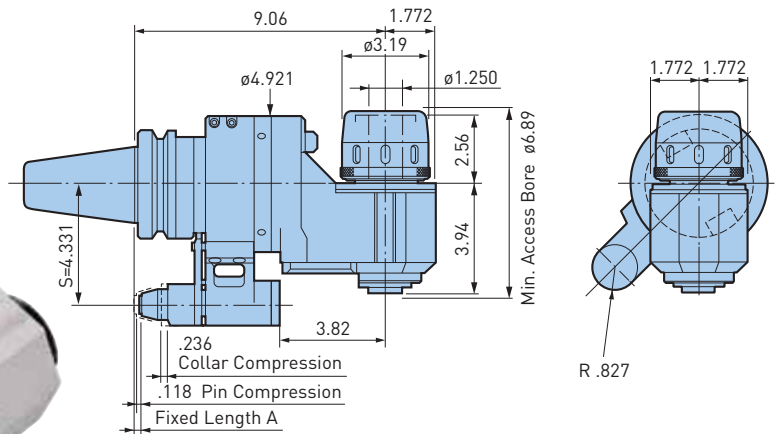

Catalog Number	Weight (lbs.)
BBT50-AG90/HMC1.250-230S	39.9

CAUTION

A Stop Block is required. The rotation of the cutting tool is in same direction of the machine spindle.

- Wrench is included
- The angles of the locating pin to the drive key groove and direction of cutting edge are freely adjustable
- A stop block is required when mounting on machines must be order separately
- When supplied through the stop block, coolant can be ejected from the housing
- Automatic tool change may not be available depending on machine tool models

ACCESSORIES



AGU UNIVERSAL TYPE

CLAMPING RANGE: ϕ .098"-.787" For Angular Operations

MAX
6,000
RPM

BBT/BT A.2

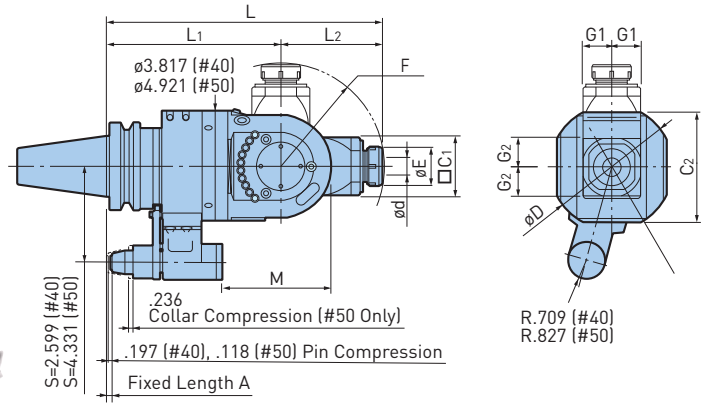

Catalog Number	ϕd	ϕE	ϕD	C1	C2	G1	G2	L	L1	L2	M	F	S	Collet	Max RPM	Weight (lbs.)
BBT40-AGU/NBS13-270	.098-.512	1.378	4.53	2.00	3.82	1.024	1.014	10.63	6.70	3.94	4.88	4.02	2.559	NBC13-□	6,000	21.4
BBT50-AGU/NBS20-315	.098-.787	1.811	5.51	2.56	4.92	1.299	1.280	12.40	7.87	4.53	4.92	4.65	4.331	NBC20-□	4,000	44.1

- Nut and wrench are included, collet must be ordered separately
- The angles of the locating pin to the drive key groove and direction of cutting edge are freely adjustable
- A stop block is required when mounting on machines must be order separately
- Automatic tool change may not be available depending on machine tool models

ACCESSORIES



CAUTION

A Stop Block is required. The rotation of the cutting tool is in reverse direction of the machine spindle (Speed Ratio 1:1).



Exclusive Clamping Bolts and Nuts

Specially selected materials and special design for clamping the head guarantees rigidity even for end milling applications.

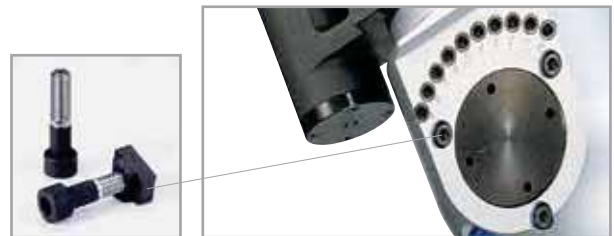

APPLICATION EXAMPLE

Adjustable AGU Universal Series expands ANGLE HEAD capabilities to accomplish various angular machining applications.

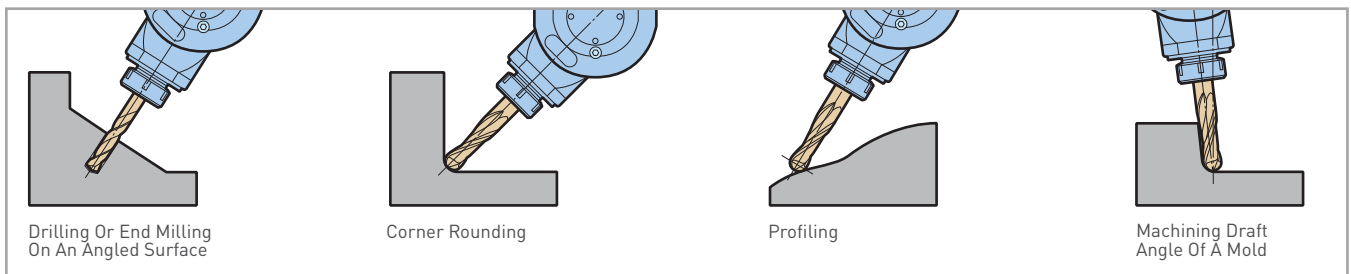

AGU30 TYPE

CLAMPING RANGE: ϕ .098"-.787" For Angular Operations



Angle Adjustment by Aligning Divisions

Spindle angle is easily adjustable from 0° to 30° using the scale indication on the body.

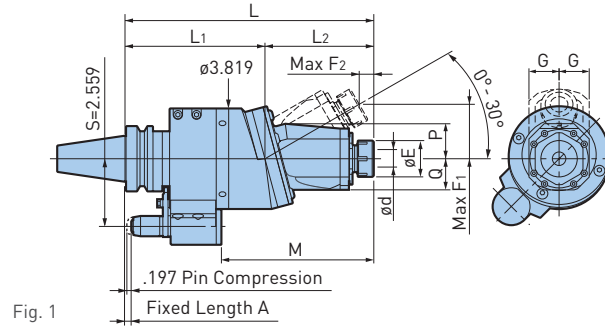
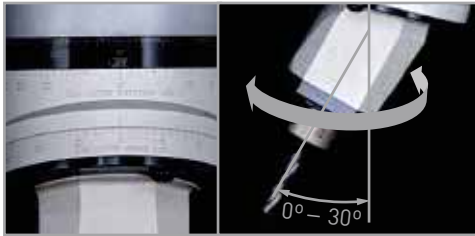

Fig. 1

**MAX
6,000
RPM**

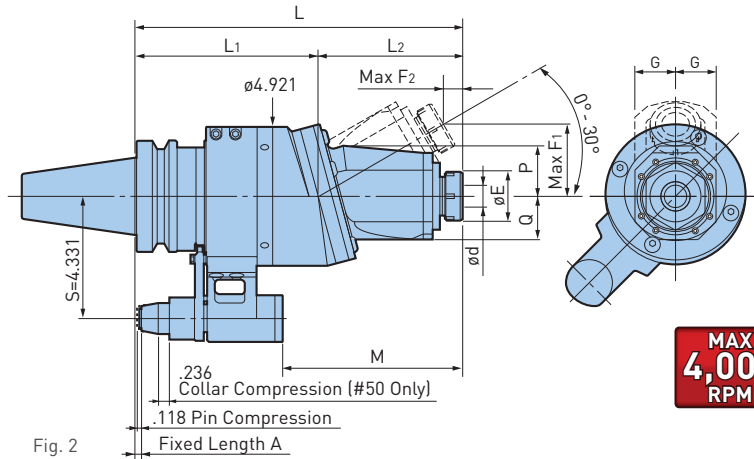

Fig. 2

**MAX
4,000
RPM**

Catalog Number	Fig.	ϕd	ϕE	G	L	L1	L2	M	P	Q	F1	F2	Collet	Max RPM	Weight (lbs.)
BBT40-AGU30/NBS13-240	1	.098-.512	1.378	1.142	9.45	5.32	4.12	5.79	1.34	1.18	2.07	.55	NBC13-□	1 : 1	15.3
BBT50-AGU30/NBS20-295	2	.098-.787	1.811	1.437	11.61	6.50	5.12	6.38	1.77	1.54	2.56	.67	NBC20-□	1 : 1	35.8

- Nut and wrench are included, collet must be ordered separately
- The angles of the locating pin to the drive key groove and direction of cutting edge are freely adjustable
- A stop block is required when mounting on machines must be order separately
- Automatic tool change may not be available depending on machine tool models
- When supplied through the stop block, coolant can be ejected from the housing

ACCESSORIES



CAUTION

A Stop Block is required. The rotation of the cutting tool is in reverse direction of the machine spindle (Speed Ratio 1:1).

SETTING DISC (INCLUDED)

For the precise adjustment of spindle angle or direction.

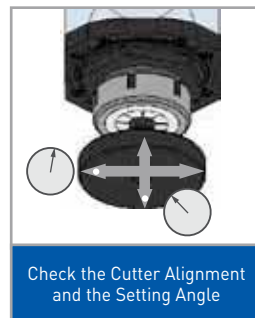

AIR POWER SPINDLE—RBX5 & RBX7 For High Speed Micro Machining with Automatic Tool Change

**MAX
80,000
RPM**

BBT/BT
A.2

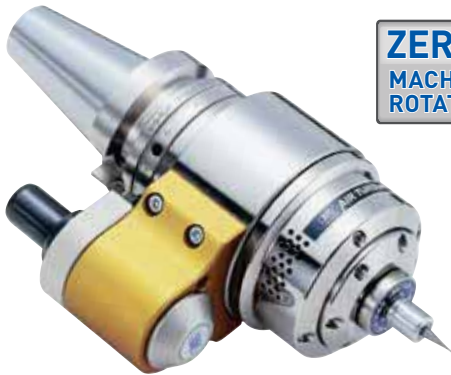

**ZERO
MACHINE SPINDLE
ROTATION**

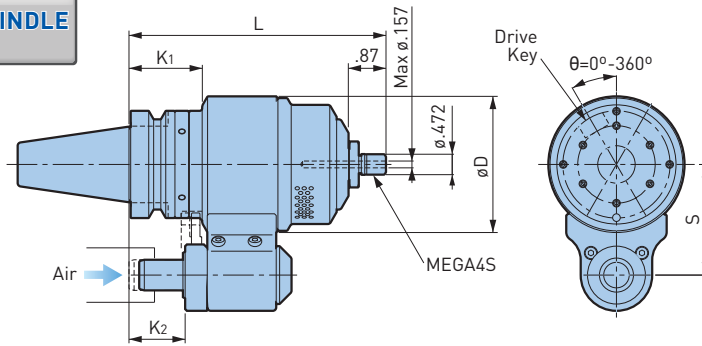

Catalog Number	Practical Spindle Speed (RPM)	Cutting Diameter	L	øD	K1	K2	S	Weight (lbs.)
BBT30-RBX7-4S-152-55	60,000-80,000	ø.039 or smaller	5.98	3.150	1.10	1.30	2.165	6.0
BBT40-RBX7-4S-151-65	60,000-80,000	ø.039 or smaller	5.95	3.150	1.69	1.30	2.559	8.8
-RBX5-4S-151-65	40,000-50,000	ø.059 or smaller		3.780				11.0
BBT50-RBX7-4S-166-80	60,000-80,000	ø.039 or smaller	6.54	3.937	2.28	1.89	3.150	19.2
-RBX5-4S-166-80	40,000-50,000	ø.059 or smaller						21.4

- Nut and wrench are included, collet must be ordered separately
- XF1-NPT (Air Unit) must be ordered separately

CAUTION ⚠

Compressed air to drive the AIR POWER SPINDLE must be clean. Coolant should not be supplied through the spindle on the machine that uses the AIR POWER SPINDLE.

For High Speed Micro Machining with Compressed Air Through the Machine Spindle

**MAX
80,000
RPM**

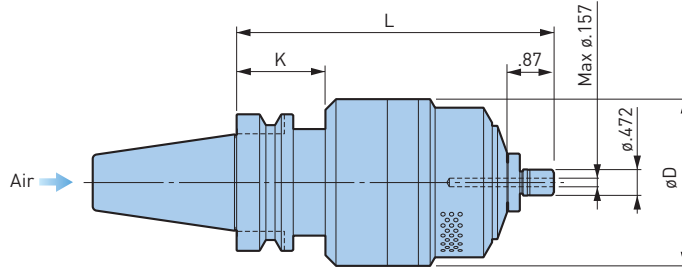
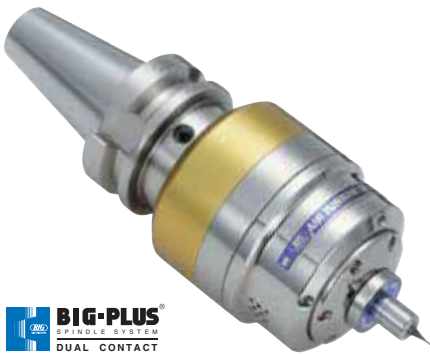

Catalog Number	Practical Spindle Speed (RPM)	Cutting Diameter	L	øD	K	Weight (lbs.)
BBT40-RBX7C-4S-150	60,000-80,000	ø.039 or smaller	5.91	3.071	1.69	6.8
-RBX5C-4S-150	40,000-50,000	ø.059 or smaller		3.780		9.0
BBT50-RBX7C-4S-160	60,000-80,000	ø.039 or smaller	6.30	3.071	2.09	13.9
-RBX5C-4S-160	40,000-50,000	ø.059 or smaller		3.780		16.1

- Nut and wrench are included, collet must be ordered separately
- XF1-NPT (Air Unit) is required must be ordered separately

CAUTION ⚠

Compressed air to drive the AIR POWER SPINDLE must be clean. Coolant should not be supplied through the spindle on the machine that uses the AIR POWER SPINDLE.

ACCESSORIES



AIR POWER SPINDLE—RBX12 For High Speed Micro Machining with Small Cutter

**MAX
120,000
RPM**

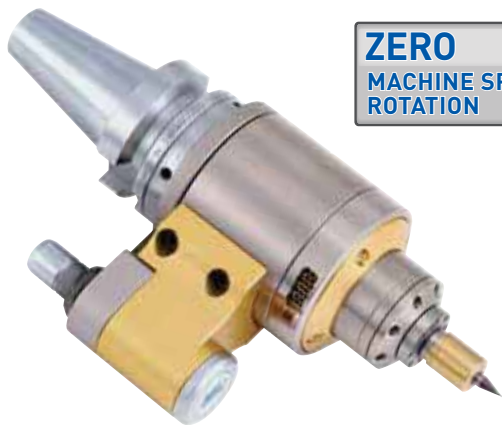

**ZERO
MACHINE SPINDLE
ROTATION**

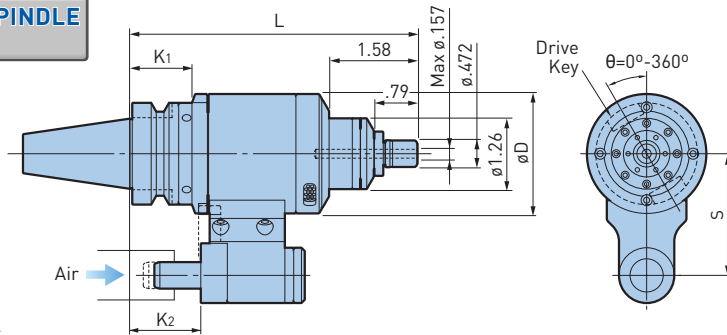

Catalog Number	Operating Spindle Speed (RPM)	Cutting Tool Diameter	L	øD	K1	K2	S	Nut	Collet	Weight (lbs.)
BBT30-RBX12-4S-130-55	100,000-120,000	.024 or smaller	5.12	2.13	1.10	1.26	2.165	MGN4S-HG	NBC4S-□	1.5
BBT40-RBX12-4S-135	100,000-120,000	.024 or smaller	5.32	2.48	—	1.30	2.559	MGN4S-HG	NBC4S-□	2.9

- Nut and wrench are included, collet must be ordered separately
- XF1-NPT (Air Unit) must be ordered separately

CAUTION ⚠

Compressed air to drive the AIR POWER SPINDLE must be clean. Coolant should not be supplied through the spindle on the machine that uses the AIR POWER SPINDLE.

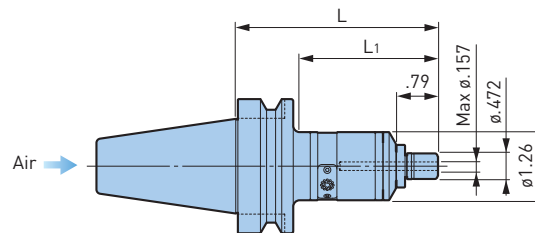

**MAX
120,000
RPM**

Catalog Number	Operating Spindle Speed (RPM)	Cutting Tool Diameter	L	L1	Nut	Collet	Weight (lbs.)
BBT30-RBX12C-4S-95	100,000-120,000	.024 or smaller	3.74	2.76	MGN4S-HG	NBC4S-□	1.5
BBT40-RBX12C-4S-95	100,000-120,000	.024 or smaller	3.74	2.56	MGN4S-HG	NBC4S-□	2.9

- Nut and wrench are included, collet must be ordered separately
- XF1-NPT (Air Unit) is required must be ordered separately

CAUTION ⚠

Compressed air to drive the AIR POWER SPINDLE must be clean. Coolant should not be supplied through the spindle on the machine that uses the AIR POWER SPINDLE.

ACCESSORIES



APPLICATION EXAMPLE

PREHARDENED STEEL NAK55 SHOULDER CUTTING		
RBX12	Cutter	ø.6mm Carbide End Mill (ø.024")
	Spindle Speed	120,000 RPM ⇄ 116,000 RPM
	Feed	520 mm/min [20.5 IPM]
	D.O.C.	Ad .035" Rd .001"

PREHARDENED STEEL NAK55 GROOVING		
RBX12	Cutter	ø.6mm Carbide End Mill (ø.024")
	Spindle Speed	120,000 RPM ⇄ 116,000 RPM
	Feed	260 mm/min [10.2 IPM]
	D.O.C.	Ad .002"

HIGH SPINDLE

CLAMPING RANGE: ϕ .059"-.630" For Higher Spindle Speeds



BBT/BT A.2

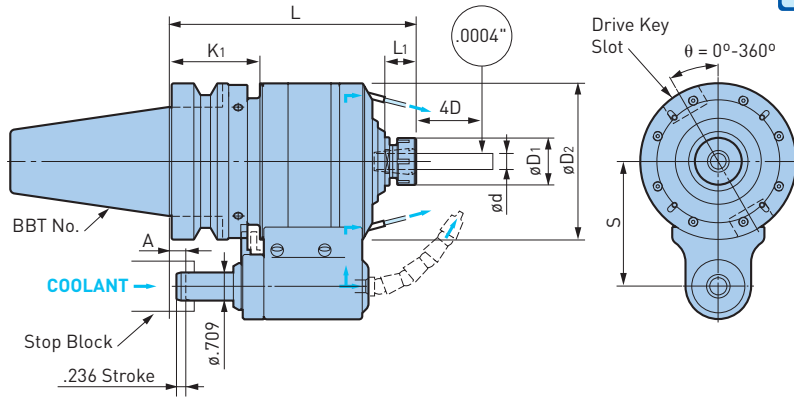

Catalog Number	ϕ d	L	L1	ϕ D1	ϕ D2	K1	S	A	Speed Ratio	Max RPM	Weight (lbs.)
BBT40-GTG5-10-140-65	.059-.394	5.51	.79	1.181	3.150	1.69	2.559	-.354 +.236	4.67	20,000	10.6
BBT50-GTG6-10-158-80	.059-.394	6.22	.79	1.181	3.937	2.28	3.150	-.354 +.236	5.67	20,000	19.4
-GTG4-16-177-80	.098-.630	6.97	1.00	1.654	4.331	2.28	3.150	-.354 +.236	3.80	15,000	23.4

- NEW BABY COLLET, nut and 2 tightening wrenches are included
- The allowable torque is a calculated value of the drive system, and not the actual torque in cutting
- The maximum diameter when using an endmill is ϕ 8mm (GTG5, GTG6) and ϕ 12 (GTG4)
- A Stop Block is required when mounting on machines
- For continuous rotation of over 30 minutes, the spindle speed should be set within 80% of the maximum speed

CAUTION **A Stop Block is required.**

ACCESSORIES



APPLICATION EXAMPLE

	GTG5	GTG6	GTG6	GTG4
Cutter	Solid carbide end mill ϕ .315"/ 2 flutes	Solid carbide end mill ϕ .236"/ 2 flutes	Solid carbide drill ϕ .079"	Solid carbide end mill ϕ .630"
Workpiece	Duralumin (A-2017)	1055	Duralumin (A-2017)	Duralumin (A-2017)
Spindle Speed	20,000 RPM	16,000 RPM	20,000 RPM	15,000 RPM
Cutting Feed	118.1 IPM	137.8 IPM	78.7 IPM	39.4 IPM
Results	High metal removal rate 5.5 cu.in./min.	High metal removal rate 2.1 cu.in./min.	Extended tool life 1,200 holes by 1 drill	Surface roughness RMS max. .00008"

- Results will vary depending on workpiece, cutting tool, machine model and other conditions
- The rigidity and concentricity are often affected by the projection length of a cutting tool, it is recommended to keep the projection as short as possible



Hi-JET HOLDER—NBS TYPE

CLAMPING RANGE: ϕ .118"-.787" For Small Diameter Drills, Gun Drills & End Mills

MAX
10,000
RPM

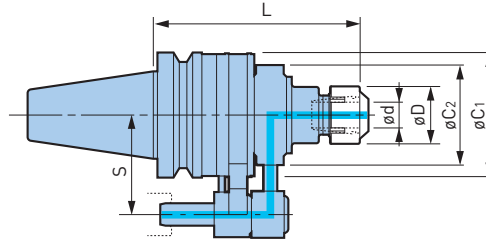
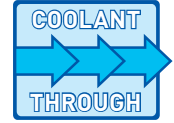

Catalog Number	ϕd	ϕD	L	ϕC_1	ϕC_2	S	Max RPM	Merit Set (2 pcs. of Merit Ring) (2 pcs. of Merit Plate)	Perfect Seal	Weight (lbs.)
BBT40-ONBS13N-165	.118-.512	1.378	6.61	3.213	2.87	2.559	10,000	MES-40	BPS13	8.8
-ONBS20N-165	.118-.787	1.811			3.15		8,000	MES-50	BPS20	9.5
BBT50-ONBS13N-165	.118-.512	1.378	6.61	3.921	3.15	3.150	8,000	MES-50	BPS13	16.1
-ONBS20N-165	.118-.787	1.811			3.15		8,000	MES-50	BPS20	16.5

- Collet, adjusting screw, clamping nut and wrench must be ordered separately
- Max coolant pressure is 284 PSI
- Other sizes available upon request

CAUTION

A Stop Block is required.

ACCESSORIES



Hi-JET HOLDER—CKB TYPE

MAX
6,000
RPM

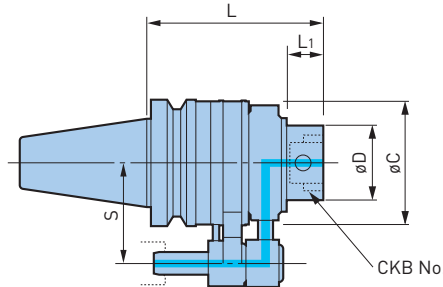
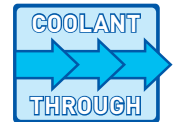

Catalog Number	CK	ϕD	L	L1	ϕC	S	Max RPM	Merit Set (2 pcs. of Merit Ring) (2 pcs. of Merit Plate)	Weight (lbs.)
BBT40-OCKB6N-149	CKB6	2.520	5.87	1.102	3.92	2.559	6,000	MES-65	13.4
BBT50-OCKB6N-139	CKB6	2.520	5.47	1.063	3.92	3.150	6,000	MES-65	15.9
-OCKB7N-165	CKB7	3.543	6.50	1.358	5.10	3.150	4,000	MES-90	27.0

- Max coolant pressure is 284 PSI

CAUTION

A Stop Block is required.

ACCESSORIES



Hi-JET HOLDER—TG TYPE

CLAMPING RANGE: ϕ .093"-1.000" For TG100 Single Angle Style Collets

MAX
8,000
RPM

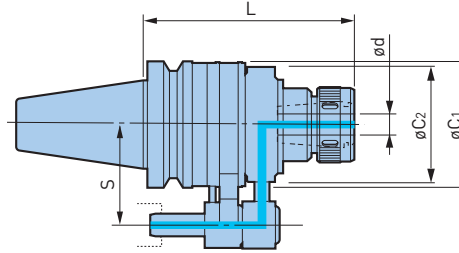
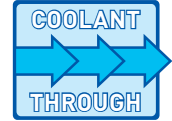

Catalog Number	Collet Series	ϕd	L	$\phi C1$	$\phi C2$	S	Max RPM	Merit Set (2 pcs. of Merit Ring) (2 pcs. of Merit Plate)	Weight (lbs.)
BT40-OHC1.000N-175	.093-1.000	TG100	6.89	3.213	3.15	2.559	8,000	MES-50	11.1

- Max coolant pressure is 284 PSI
- Nut included, collets not available from BIG KAISER

ACCESSORIES



CAUTION

A Stop Block is required.

Hi-JET HOLDER—OSL TYPE

CLAMPING RANGE: ϕ .750"-1.500" For Straight Shanks with Flat

MAX
8,000
RPM

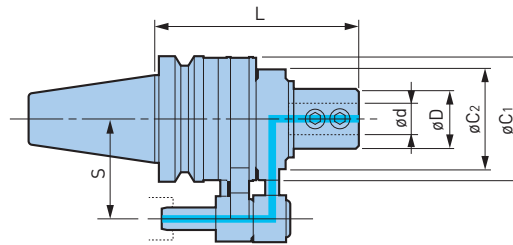
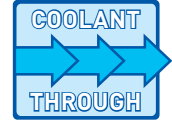

Catalog Number	ϕd	ϕD	L	$\phi C1$	$\phi C2$	S	Max RPM	Merit Set (2 pcs. of Merit Ring) (2 pcs. of Merit Plate)	Weight (lbs.)
BT40-OSL1.000N-165	1.000	1.890	6.50	3.213	3.15	2.559	8,000	MES-50	9.7
-OSL1.250N-165	1.250	2.283		3.921	3.86		6,000	MES-65	12.6
BT50-OSL.750N-150	.750	1.890	5.91	3.921	3.15	3.150	8,000	MES-50	16.3
-OSL1.000N-165	1.000								16.5
-OSL1.250N-165	1.250	2.283	6.50				3.86	6,000	MES-65
-OSL1.500N-165	1.500	2.500	17.6						

- Max coolant pressure is 284 PSI

ACCESSORIES



CAUTION

A Stop Block is required.

Before Ordering

Be sure to check the dimensions of the required pullstud bolt by referring to the specification sheet of the machine tool. In the case of machines with coolant-through spindle capability, provide us a copy of the pullstud bolt drawing, as the sealing method may vary even among machines with the same model number.

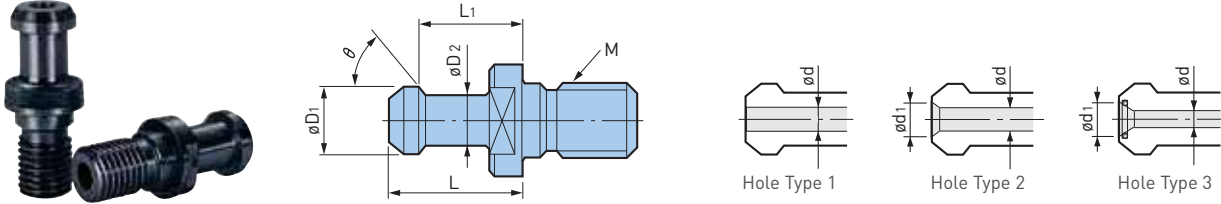

Spindle Type	Catalog Number	Standard	ϕD_1	ϕD_2	L	L_1	θ	ϕd	ϕd_1	Hole Type	Standard or Machine Make			
30 [M12]	30PMG	JIS	.472	.31	.92	.724	75	None	—	—	JIS BT30			
	30PMGH							.16	—	1	JIS BT30 With Hole			
	30PMGH2							.10	.22	3	YASDA			
	P30T-1MG	MAS-I	.433	.28	.91	.709	45	None	—	—	MAS-1 BT30			
	P30T-1MGH							.10	—	1	MAS-1 BT30 With Hole			
	P30T-2MG	MAS-II	.433	.28	.91	.709	60	None	—	—	MAS-2 BT30			
	P30T-2MGH							.10	—	1	MAS-2 BT30 With Hole			
	30P-1MGH	Original	.433	.31	.91	.709	45	.10	—	1	FANUC			
	P30T-2MGH3										.16	—	1	BROTHER
	PM030MG										.433	.28	.91	.709
40 [M16]	40PMG	JIS	.748	.55	1.14	.906	75	None	—	—	JIS BT40			
	40PMGH							.28	—	1	JIS BT40 With Hole			
	40PMGH2							.28	—	1	MAKINO (Ground Face)			
	40PMGH7							.16	.20	2	OKUMA (Ground Face)			
	40PMGH4A							.28	—	1	YASDA $\phi 3$ Side Hole			
	40PMGH11							.39	3	YASDA				
	40PMGH12							.20	—	1	mitsui			
	P40T-1MG	MAS-I	.591	.39	1.38	1.102	45	None	—	—	MAS-1 BT40			
	P40T-1MGHA							.12	—	1	MAS-1 BT40 With Hole			
	P40T-1MGH4							.12	.28	3	OKUMA			
	P40T-1MGH7							.16	—	1	MAKINO (Ground Face)			
	P40T-1MGH8A							.12	.28	3	JTEKT			
	P40T-2MG	MAS-II	.591	.39	1.38	1.102	60	None	—	—	MAS-2 BT40			
	P40T-2MGHA							.12	—	1	MAS-2 BT40 With Hole			
	P40T-2MGH8							.14	.22	2				
	P40T-2MGH1							.12	.28	3	OKUMA			
	MP40MG	Original	.591	.39	.98	.709	90	None	—	—	MITSUI SEIKI			
	POM40MG										.591	.39	1.38	1.102
	POM40MGF		DMG MORI Form B w/O-Ring											
	PM040MG		.748	.55	1.14	.906	75	.28	.39	3				
PYN40MG	.740		.57	.75	.552	45	.28	—	1	MAZAK				

- Machine tool builders have used many various shapes and sizes of retention knobs
- The use of the incorrect knob may result in injury or property damage for your machining center

TOOL
STEEL

MEGA PULLSTUD BOLT

MG in the model numbers stand for MEGA PULLSTUD BOLT. Tensile strength is improved by utilizing tool steel. Especially recommended for BIG-PLUS dual contact applications.

PULLSTUD WRENCHES

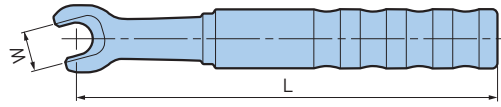

Taper Type & Size	Catalog Number	W	L	Pullstud
BBT30 BT30	PLW30	.512	5.51	JIS, MAS-1, MAS-2 30P-1MGH, P30T-2MGH3, PMO30MG
BBT40 BT40	PLW-40P	.748	7.87	JIS
	PLW-P40T			MAS-1, MAS-2, POM40MG
	PLW-MP40			MP40
	PLW-PMO40			PMO40MG
	PLW-PYN40			PYN40MG

• If appearance shape is the same, the specification other than above is also usable

DYNA TEST

Helps identify potential problems, and can reduce downtime and costly repairs of the machine tool spindle.

BBT/BT
A.2

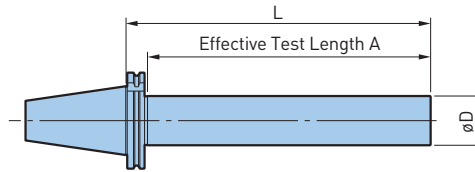

Catalog Number	L	A	øD
BBT30-32-L150	5.906	4.921	32mm
-32-L235	9.252	8.268	
BBT40-50-L200	7.874	6.693	50mm
-50-L350	13.780	12.598	
BBT50-50-L200	7.784	6.260	50mm
-50-L360	14.173	12.559	

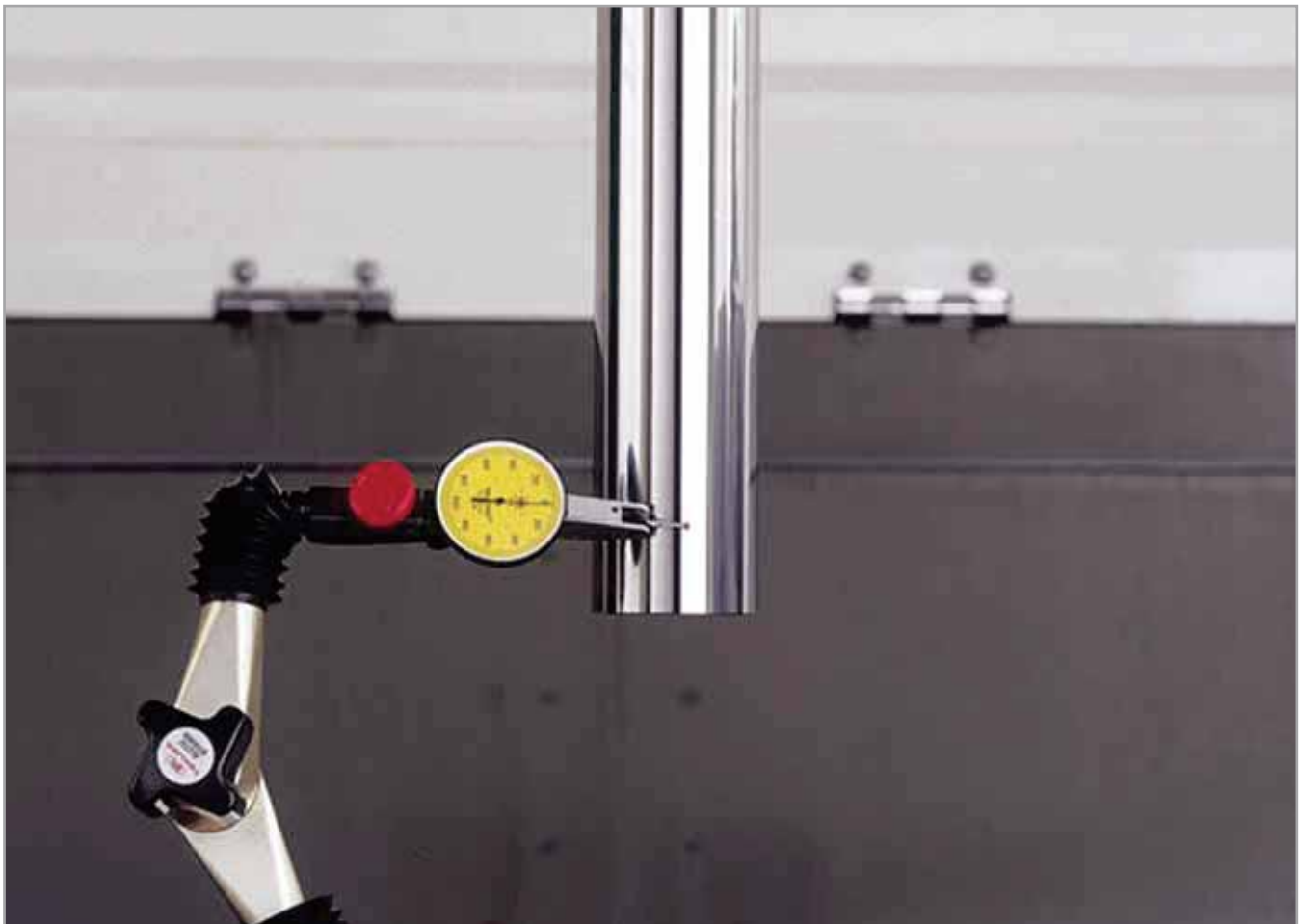

ATC ALIGNMENT TOOL

For re-aligning the center between the machine tool spindle and ATC gripper. It can also be used for re-aligning the ATC gripper and tool magazine pots. More detailed information on page 608.

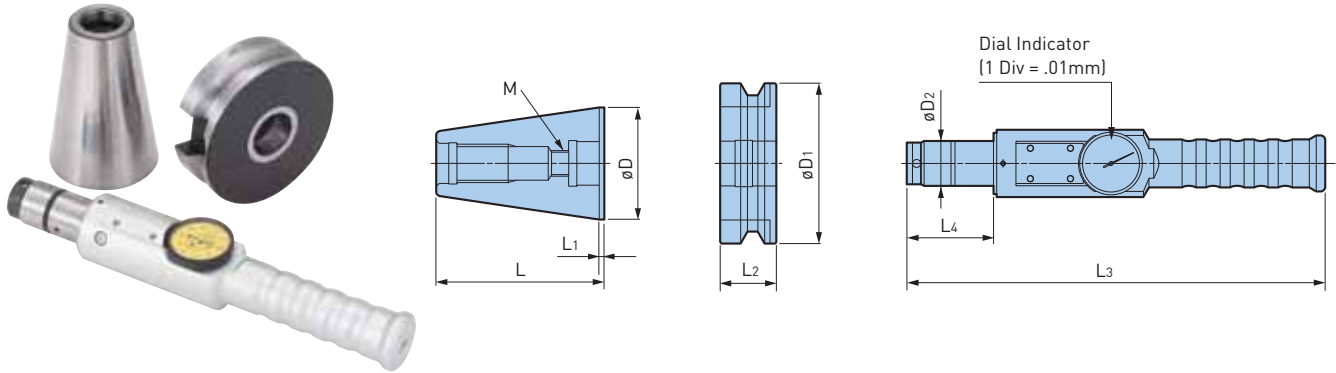

Catalog Number	øD	øD1	øD2	L	L1	L2	L3	L4	M
BT30-ATC18	31.75mm	46mm	18mm	50.4mm	2mm	20mm	251mm	44mm	12mm
BT40-ATC20	44.45mm	63mm	20mm	67.4mm	2mm	25mm	251mm	44mm	12mm
BT50-ATC28	69.85mm	100mm	28mm	104.8mm	3mm	35mm	261mm	54mm	16mm

BIG-PLUS CLEANER

Blowing air cleans the BIG-PLUS machine spindle face of all debris.

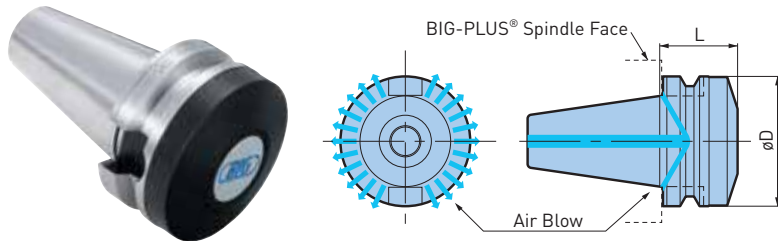

Catalog Number	L	øD
SBT30-ASC-30T	1.181	1.811
SBT40-ASC-40T	1.575	2.480
SBT50-ASC-60T	2.362	3.937

- When the cleaner is clamped into a BIG-PLUS machine spindle, faces have 1mm (.039") clearance

DUAL CONTACT A/E/F TYPES

HSK SHANK

A.3

HSK A.3



HSK-A

COLLET CHUCKS 170-179

MEGA MICRO CHUCK	170-171
MEGA NEW BABY CHUCK	172-175
MEGA ER GRIP	176-177
MEGA E CHUCK	178-179

MILLING CHUCKS 180-183

MEGA DOUBLE POWER CHUCK	180
MEGA PERFECT GRIP	181
NEW Hi-POWER MILLING CHUCK	182-183

HYDRAULIC CHUCKS 184-187

BASIC ARBORS 188-195

SHRINK FIT HOLDERS	188-189
END MILL HOLDERS	191
SHELL/FACE MILL HOLDERS	192-193
SMART DAMPER MILLING	194-195

TAP HOLDERS 196-197

MEGA SYNCHRO TAPPING HOLDER	196-197
-----------------------------	---------

MODULAR HOLDERS 198-199

CKB SHANK	198-199
-----------	---------

ANGLE HEADS 200-209

AG90	200-207
AGU	208-209

SPINDLE SPEEDERS 210-211

AIR POWER SPINDLE	210-211
-------------------	---------

HSK-E

COLLET CHUCKS 212-215

MEGA MICRO CHUCK	212-213
MEGA NEW BABY CHUCK	214-215

HYDRAULIC CHUCKS 216-217

BASIC HOLDERS 218

SHRINK FIT HOLDERS	218
--------------------	-----

MODULAR HOLDERS 219

CKB SHANKS	219
------------	-----

SPINDLE SPEEDERS 220

AIR POWER SPINDLE	220
-------------------	-----

HSK-F

COLLET CHUCKS 221-224

MEGA MICRO CHUCK	221
MEGA NEW BABY CHUCK	222
MEGA E CHUCK	223
MEGA DOUBLE POWER CHUCK	224

HYDRAULIC CHUCKS 225

BASIC ARBORS 226

FACE MILL ARBOR	226
-----------------	-----

MODULAR HOLDERS 227

CKB SHANK	227
-----------	-----

ACCESSORIES 228-229

COOLANT PIPES	228
DYNA TEST	229

MEGA MICRO CHUCK—TAPERED BODY

CLAMPING RANGE: ϕ .018"–.317" (ϕ .45–8.05mm) For Micro Drill & End Mill Applications

HIGHER RIGIDITY

MAX 45,000 RPM

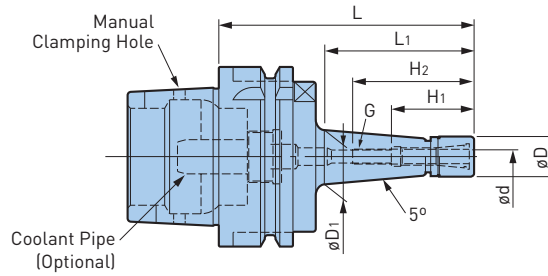

HSK A.3

Catalog Number	ϕd	ϕD	ϕD_1	L	L ₁	H ₁	H ₂	G	Collet	Wrench	Max RPM	Weight (lbs.)
HSK-A32-MEGA6S-50T	.018-.238	.551	.58	1.97	.87	1.12	1.30	—	NBC6S-□	MGR14	45,000	.4
-60T			.63	2.36	1.18		1.69	—			40,000	.4
-105T			.87	4.13	2.99		2.48	M7 P0.75			35,000	.6
HSK-A40-MEGA3S-75T	.018-.128	.394	.57	2.95	1.57	.87	1.50	M4 P0.7	NBC3S-□	MGR10	32,000	.6
-90T			.68	3.54	2.20						28,000	.7
-MEGA4S-60T	.018-.159	.472	.55	2.36	1.02	1.04	1.73	M5 P0.8	NBC4S-□	MGR12	35,000	.6
-90T			.76	3.54	2.28		1.85				28,000	.7
-105T			.87	4.13	2.87		25,000				.8	
-MEGA6S-60T ❖	.018-.238	.551	.61	2.36	1.06	1.12	[1.57]	M7 P0.75	NBC6S-□	MGR14	35,000	.6
-75T			.72	2.95	1.69		32,000				.7	
-90T			.83	3.54	2.32		1.93				28,000	.8
-105T			.94	4.13	2.91		25,000				.9	
HSK-A50-MEGA6S-105T	.018-.238	.551	.87	4.13	2.56	1.12	1.93	M7 P0.75	NBC6S-□	MGR14	25,000	1.3
HSK-A63-MEGA3S-75T	.018-.128	.394	.54	2.95	1.38	.87	1.50	M4 P0.7	NBC3S-□	MGR10	32,000	1.8
-120T			.85	4.72	3.15						25,000	2.0
-MEGA4S-75T	.018-.159	.472	.61	2.95	1.38	1.04	1.85	M5 P0.8	NBC4S-□	MGR12	32,000	1.8
-90T			.71	3.54	1.97						28,000	1.9
-120T			.92	4.72	3.15						22,000	2.1
-MEGA6S-60T	.018-.238	.551	.61	2.36	.91	1.12	1.46	M7 P0.75	NBC6S-□	MGR14	35,000	1.8
-75T			.67	2.95	1.38		1.89				32,000	1.8
-90T			.77	3.54	1.97		1.93				28,000	1.9
-105T			.87	4.13	2.56		25,000				2.0	
-120T			.98	4.72	3.15		22,000				2.1	
-135T			1.08	5.31	3.74		20,000				2.2	
-MEGA8S-90T	.116-.317	.709	.92	3.54	2.01	1.22	1.99	M9 P0.75	NBC8S-□	MGR18	30,000	2.0
-120T			1.12	4.72	3.19						23,000	2.3

- MEGA MICRO NUT is included, coolant pipe, collet and wrench must be ordered separately
- Weight includes nut but does not include collet
- For models marked ❖, there is no internal thread, the dimension H₂ in () shows how deep a tool can be inserted
- Please note that the practical spindle speed may be considerably influenced by the machine rigidity and tool balance, when using, slowly ramp up to the appropriate speed starting from slow speeds

ACCESSORIES



MEGA MICRO CHUCK

CLAMPING RANGE: $\varnothing.018$ "-.317" ($\varnothing.45$ -8.05mm) For Micro Drill & End Mill Applications

MAX
38,000
RPM

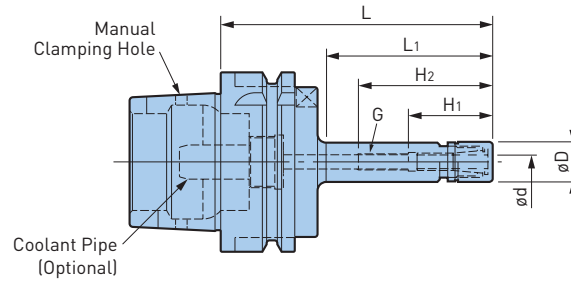

Catalog Number	$\varnothing d$	$\varnothing D$	L	L ₁	H ₁	H ₂	G	Collet	Wrench	Max RPM	Weight (lbs.)
HSK-A32-MEGA6S-60	.018-.238	.551	2.36	1.18	.93	1.69	—	NBC6S-□	MGR14	38,000	.4
-105			4.13	2.99		1.93	M7 P0.75			20,000	.6
HSK-A40-MEGA3S-60	.018-.128	.394	2.36	1.02	.87	1.54	M4 P0.7	NBC3S-□	MGR10	30,000	.6
-MEGA4S-60	.018-.159	.472	2.36	1.06	1.04	1.73	M5 P0.8	NBC4S-□	MGR12	30,000	.6
-90			3.54	2.24		1.85				25,000	.6
-MEGA6S-60❖	.018-.238	.551	2.36	1.50	—	(1.57)	—	NBC6S-□	MGR14	30,000	.6
-90			3.54	2.28	1.12	1.93	M7 P0.75			25,000	.7
HSK-A50-MEGA4S-75	.018-.159	.472	2.95	1.42	1.04	1.85	M5 P0.8	NBC4S-□	MGR12	30,000	1.1
-MEGA6S-75	.018-.238	.551	2.95	1.42	1.12	1.93	M7 P0.75	NBC6S-□	MGR14	30,000	1.1
HSK-A63-MEGA4S-75	.018-.159	.472	2.95	1.42	1.04	1.89	M5 P0.8	NBC4S-□	MGR12	30,000	1.8
-105			4.13	2.40		1.85				25,000	1.8
-MEGA6S-75	.018-.238	.551	2.95	1.42	1.12	1.89	M7 P0.75	NBC6S-□	MGR14	30,000	1.8
-105			4.13	2.40		1.93				25,000	1.9
-MEGA8S-90	.116-.317	.709	3.54	1.89	1.22	1.99	M9 P0.75	NBC8S-□	MGR18	30,000	2.0

- MEGA MICRO NUT is included, coolant pipe, collet and wrench must be ordered separately
- Weight includes nut but does not include collet
- For models marked ❖, there is no internal thread, the dimension H₂ in () shows how deep a tool can be inserted
- Please note that the practical spindle speed may be considerably influenced by the machine rigidity and tool balance, when using, slowly ramp up to the appropriate speed starting from slow speeds

ACCESSORIES



A.3
HSK

MEGA NEW BABY CHUCK

CLAMPING RANGE: ϕ .010"-1.000" (ϕ .25-25.4mm)

For Drills, Reamers, Taps & Finishing End Mills

MAX
35,000
RPM

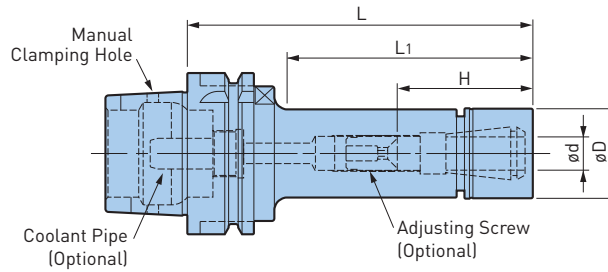
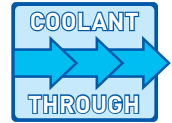

HSK A.3

Catalog Number	ϕd	ϕD	L	L1	H	Collet	Nut	Wrench	Max RPM	Weight (lbs.)		
HSK-A32-MEGA6N-75	.010-.236	.787	2.95	1.46	.91-1.69	NBC6-□	MGN6	MGR20	30,000	.6		
-MEGA8N-50	.020-.315	.984	1.97	1.02	1.26	NBC8-□	MGN8	MGR25	33,000	.5		
HSK-A40-MEGA6N-60❖	.010-.236	.787	2.36	1.18	1.30	NBC6-□	MGN6	MGR20	35,000	.7		
-75			2.95	1.77	.91-1.50						30,000	.8
-90			3.54	2.36	.91-1.69							
-MEGA8N-60❖	.020-.315	.984	2.36	1.18	1.61	NBC8-□	MGN8	MGR25	35,000	.8		
-90			3.54	2.36	1.02-1.73						30,000	1.0
-MEGA10N-60❖	.059-.394	1.181	2.36	1.02	1.57	NBC10-□	MGN10	MGR30	35,000	.9		
-90			3.54	2.13	1.50-1.89						30,000	1.2
-MEGA13N-75❖	.098-.512	1.378	2.95	2.17	2.17	NBC13-□	MGN13	MGR35	25,000	1.2		
-90❖			3.54	2.76	2.52						1.4	
-MEGA16N-75❖	.098-.630	1.654	2.95	2.17	2.09	NBC16-□	MGN16	MGR42	20,000	1.4		
-90❖			3.54	2.76	2.48						15,000	1.7
-MEGA20N-90❖	.098-.787	1.811	3.54	2.76	2.60	NBC20-□	MGN20	MGR46	15,000	1.9		



Catalog Number	ød	øD	L	L1	H	Collet	Nut	Wrench	Max RPM	Weight (lbs.)
HSK-A50-MEGA6N-75	.010-.236	.787	2.95	1.46	.91-1.69	NBC6-□	MGN6	MGR20	30,000	1.3
-100			3.94	2.76					25,000	1.3
-135			5.31	3.66					20,000	1.5
-MEGA8N-75	.020-.315	.984	2.95	1.46	1.02-1.46	NBC8-□	MGN8	MGR25	30,000	1.3
-100			3.94	2.44	1.02-1.77				28,000	1.5
-135			5.31	3.78	20,000				1.8	
-MEGA10N-75❖	.059-.394	1.181	2.95	1.50	1.81	NBC10-□	MGN10	MGR30	33,000	1.5
-100			3.94	2.48	1.50-1.89				25,000	1.8
-135			5.31	3.86	20,000				2.2	
-MEGA13N-75❖	.098-.512	1.378	2.95	1.57	1.81	NBC13-□	MGN13	MGR35	28,000	1.5
-100			3.94	2.56	1.73-2.20				25,000	2.0
-135			5.31	3.94	1.73-2.87				18,000	2.4
-MEGA16N-75❖	.098-.630	1.654	2.95	1.93	1.89	NBC16-□	MGN16	MGR42	28,000	2.2
-100			3.94	2.91	1.89-2.17				20,000	2.4
-135			5.31	4.29	1.89-2.68				15,000	3.1
-MEGA20N-75❖◆	.098-.787	1.811	2.95	1.93	1.85	NBC20-□	MGN20	MGR46	20,000	2.0
-100			3.94	2.91	2.01-2.13				15,000	2.4
-135			5.31	4.29	2.01-2.68				10,000	3.3
-MEGA25N-95❖	.610-1.000	2.326	3.74	2.72	2.56	NBC25-□	MGN25	MGR60L	12,000	2.9

- MEGA NEW BABY NUT is included, coolant pipe, collet, wrench and adjusting screw must be ordered separately
- Weight includes nut but not collet
- Please note that the practical spindle speed may be considerably influenced by the machine rigidity and tool balance, when using, slowly ramp up to the appropriate speed starting from slow speeds
- "H" dimension is the Max tool shank length that can be inserted into the holder
- Adjusting screws cannot be used with models marked ❖
- NEW BABY E COLLET cannot be used with models marked ◆

ACCESSORIES



MEGA NEW BABY CHUCK

CLAMPING RANGE: ϕ .010"-1.000" (ϕ .25-25.4mm) For Drills, Reamers, Taps & Finishing End Mills

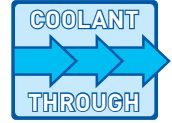

**MAX
35,000
RPM**

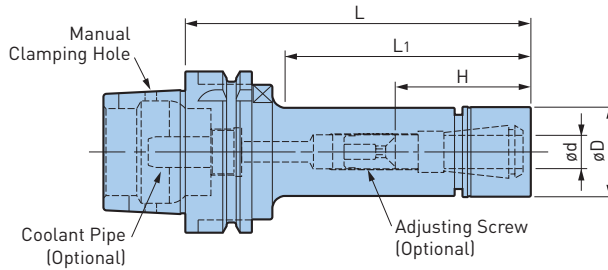

HSK A.3

Catalog Number	ϕd	ϕD	L	L ₁	H	Collet	Nut	Wrench	Max RPM	Weight (lbs.)
HSK-A63-MEGA6N-75	.010-.236	.787	2.95	1.38	.91-1.50	NBC6-□	MGN6	MGR20	35,000	2.0
-90			3.54	1.89	.91-1.69					
-105			4.13	2.48						
-120			4.72	2.99						
-135			5.31	3.58						
-165			6.50	4.76						
-MEGA8N-75	.020-.315	.984	2.95	1.38	1.02-1.50	NBC8-□	MGN8	MGR25	35,000	2.0
-90			3.54	1.97	1.02-1.77					
-105			4.13	2.48						
-120			4.72	2.99						
-135			5.31	3.58						
-165			6.50	4.76						
-MEGA10N-75 ❖	.059-.394	1.181	2.95	1.42	1.97	NBC10-□	MGN10	MGR30	33,000	2.2
-90			3.54	1.97	1.50-1.77					
-105			4.13	2.56						
-120			4.72	3.15						
-135			5.31	3.66						
-165			6.50	4.84						
-MEGA13N-75 ❖	.098-.512	1.378	2.95	1.46	1.93	NBC13-□	MGN13	MGR35	30,000	2.2
-90			3.54	2.01	2.52					
-105			4.13	2.60	1.73-2.20					
-120			4.72	3.19	1.73-2.48					
-135			5.31	3.78						
-165			6.50	4.92						
-MEGA16N-75 ❖	.098-.630	1.654	2.95	1.54	1.89	NBC16-□	MGN16	MGR42	30,000	2.4
-90			3.54	2.13	2.48					
-105			4.13	2.72	1.89-2.13					
-120			4.72	3.31	1.89-2.68					
-135			5.31	3.90						
-165			6.50	5.08						
-200	7.87	6.46								
-MEGA20N-75 ❖	.098-.787	1.811	2.95	1.54	2.01	NBC20-□	MGN20	MGR46	30,000	2.6
-90			3.54	2.13	2.40					
-105			4.13	2.72	2.01-2.13					
-120			4.72	3.31	2.01-2.68					
-135			5.31	3.90						
-165			6.50	5.08						
-200	7.87	6.46								
-MEGA25N-90 ❖	.610-1.000	2.362	3.54	—	2.48	NBC25-□	MGN25	MGR60L	20,000	3.5
-120			4.72	—	3.54					

Catalog Number	ød	øD	L	L ₁	H	Collet	Nut	Wrench	Max RPM	Weight (lbs.)
HSK-A100-MEGA6N-90	.010-.236	.787	3.54	1.69	.91-1.69	NBC6-□	MGN6	MGR20	20,000	5.5
-105			4.13	2.28					18,000	5.5
-120			4.72	2.87					14,000	5.5
-135			5.31	3.46					12,000	5.7
-165			6.50	4.45						
-MEGA8N-90			.020-.315	.984					3.54	1.69
-105	4.13	2.28			18,000	5.7				
-120	4.72	2.87			14,000	5.7				
-135	5.31	3.46				6.0				
-165	6.50	4.45				6.0				
-MEGA10N-90	.059-.394	1.181			3.54	1.69	1.50-1.77	NBC10-□	MGN10	MGR30
-105			4.13	2.28	1.50-1.89	18,000	6.0			
-120			4.72	2.87		14,000	6.0			
-135			5.31	3.46		6.2				
-165			6.50	4.45		6.6				
-MEGA13N-90❖			.098-.512	1.378	3.54	1.69	2.17			
-105❖	4.13	2.28			2.76	16,000	6.2			
-120	4.72	2.87			1.73-2.48	14,000	6.4			
-135	5.31	3.46				10,000	6.6			
-165	6.50	4.65				7.1				
-200	7.87	5.83				7.7				
-MEGA16N-90❖	.098-.630	1.654	3.54	1.85	2.17	NBC16-□	MGN16	MGR42	15,000	6.2
-105❖			4.13	2.28	2.76				14,000	6.4
-120			4.72	2.87	1.89-2.68				13,000	6.8
-135			5.31	3.46					10,000	7.1
-165			6.50	4.65					7.9	
-200			7.87	5.94					8.8	
-MEGA20N-90❖	.098-.787	1.811	3.54	1.85	2.17	NBC20-□	MGN20	MGR46	15,000	6.4
-105❖			4.13	2.28	2.76				14,000	6.6
-120			4.72	2.87	2.01-2.68				13,000	7.1
-135			5.31	3.46					10,000	7.3
-165			6.50	4.65					8.4	
-200			7.87	6.02					9.5	
-MEGA25N-120❖	.610-1.000	2.362	4.72	307	3.35	NBC25-□	MGN25	MGR60L	12,000	8.4
-165			6.50	4.84	2.52-2.91				10,000	10.1
HSK-A125-MEGA20N-120	.098-.787	1.811	4.72	3.07	2.01-2.68	NBC20-□	MGN20	MGR46	12,000	10.3
-165			6.50	4.65					10,000	11.4

- MEGA NEW BABY NUT is included, coolant pipe, collet, wrench and adjusting screw must be ordered separately
- Weight includes nut but not collet
- Center through coolant supply is available
- Please note that the practical spindle speed may be considerably influenced by the machine rigidity and tool balance, when using, slowly ramp up to the appropriate speed starting from slow speeds
- "H" indicates the adjustment length with an adjusting screw
- "H" dimension is the Max tool shank length that can be inserted into the holder
- Adjusting screws cannot be used with models marked ❖

ACCESSORIES



COLLET CHUCK

MEGA ER GRIP

CLAMPING RANGE: ϕ .075"-.787" (ϕ 1.9-20mm)

For Drills, Reamers, Taps & Finishing End Mills

MAX
33,000
RPM

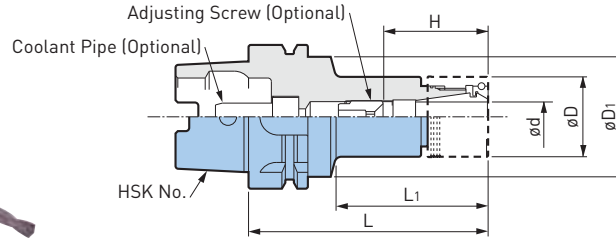
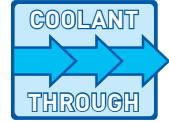

HSK A.3

Catalog Number	ϕd	ϕD	$\phi D1$	L	L1	H	Collet	Nut [NOT Included]	Wrench	Max RPM	Weight [lbs.]
HSK-A63-MEGAER16-70NL ❖	.075-.394	1.181	2.07	2.76	1.26	1.77	ERC16-□	MERN16*	MGR30L	33,000	2.2
-90NL				3.54	1.93	1.38-1.85				33,000	2.4
-105NL				4.13	2.52					25,000	2.4
-135NL				5.32	3.70					20,000	2.9
-165NL				6.50	4.88					15,000	3.1
-MEGAER20-70NL ❖	.108-.512	1.378	2.07	2.76	1.26	1.77	ERC20-□	MERN20*	MGR35L	30,000	2.2
-90NL				2.54	1.93	2.48				30,000	2.4
-105NL				4.13	2.52	1.65-2.13				25,000	2.6
-135NL				5.32	3.70	1.65-2.44				20,000	3.1
-165NL				6.50	4.88					15,000	3.5
-MEGAER25-70NL ❖	.108-.630	1.654	2.07	2.76	1.26	1.77	ERC25-□	MERN25*	MGR35L	30,000	2.4
-90NL				3.54	1.97	2.44				25,000	2.6
-105NL				4.13	2.56	1.73-2.17				20,000	3.1
-135NL				5.32	3.74	1.73-2.65				15,000	3.7
-165NL				6.50	4.92					10,000	4.2
-MEGAER32-75NL ❖	.108-.787	1.969	2.07	2.95	1.30	1.97	ERC32-□	MERN32*	MGR50L	30,000	2.9
-90NL				3.54	1.85	2.40				25,000	3.3
-105NL				4.13	2.44	1.97-2.13				20,000	3.7
-135NL				5.32	3.62	1.97-2.68				15,000	4.4
-165NL				6.50	4.80					10,000	5.3
HSK-A100-MEGAER16-75NL ❖	.075-.394	1.181	3.35	2.95	1.22	1.83	ERC16-□	MERN16*	MGR30L	20,000	7.3
-105NL				4.13	2.32	1.38-1.85				18,000	7.5
-135NL				5.32	3.50					14,000	7.9
-165NL				6.50	4.69					14,000	8.1
-MEGAER20-75NL ❖	.108-.512	1.378	3.35	2.95	1.22	1.77	ERC20-□	MERN20*	MGR35L	18,000	7.5
-105NL				4.13	2.32	1.65-2.13				16,000	7.7
-135NL				5.32	3.50	1.65-2.44				14,000	8.1
-165NL				6.50	4.69					14,000	8.6
-MEGAER25-75NL ❖	.108-.630	1.654	3.35	2.95	1.26	1.73	ERC25-□	MERN25*	MGR35L	15,000	7.5
-105NL				4.13	2.32	1.73-1.97				14,000	8.1
-135NL				5.32	3.50	1.73-2.65				13,000	8.8
-165NL				6.50	4.69					13,000	9.2
-MEGAER32-80NL ❖	.108-.787	1.969	3.35	3.15	1.42	1.93	ERC32-□	MERN32*	MGR50L	15,000	7.9
-105NL				4.13	2.32	2.79				14,000	8.6
-135NL				5.32	3.50	1.97-2.68				13,000	9.5
-165NL				6.50	4.69					13,000	10.3

Catalog Number	ød	øD	øD1	L	L1	H	Collet	Nut (NOT Included)	Wrench	Max RPM	Weight (lbs.)
HSK-A125-MEGAER16-100NL	.075-.394	1.181	4.13	3.94	2.16	1.38-1.85	ERC16-□	MERN16*	MGR30L	15,000	9.7
-160NL				6.30	4.52					12,000	10.3
-MEGAER32-100NL	.108-.787	1.969		3.94	2.16	1.97-2.68	ERC32-□	MERN32*	MGR50L	14,000	10.6
-160NL				6.30	4.52					12,000	12.3

***Nut, adjusting screw, balance screws, collet and wrench are not included**

- Weight does not include collet
- "H" indicates the adjustment length with an adjusting screw
- MEGA ER GRIP is not able to use DIN6499 Form-A collets and ESX collets
- The "max" allowable spindle speed listed in the table is directly influenced by the rigidity of the machine and balance of the cutting tool, therefore, the "max" allowable speed may not always be achievable
- Adjusting screws cannot be used with models marked ❖

CAUTION ⚠

To maintain the accuracy of the tool assembly, do not use collets and nuts manufactured by another company with the chuck body of BIG's MEGA ER GRIP. We cannot guarantee the accuracy statement for our collets if they are assembled on the chuck body of another manufacturer.

A.3 HSK

ACCESSORIES



*MEGA NUT is the recommended nut to achieve high accuracy and clamping force

High Concentricity



MEGA ER PERFECT SEAL



MEGA WRENCH

Capable of sealing high pressure coolant up to 7Mpa. For applications with coolant supplied through the tools. MEGA Wrench is used for tightening.



MEGA ER NUT*



MEGA WRENCH

High accuracy and clamping force are provided with thrust ball bearings. Ideal for solid carbide drills and reamers. Slot-free outer diameter increases rigidity of the nut itself. The one-way clutch of the MEGA Wrench tightens the nut securely and easily by ratchet function.



MEGA ER SOLID NUT



MEGA WRENCH

High performance solid nut with surface treatment for friction reduction. Slot-free outer diameter increases rigidity of the nut itself. The one-way clutch of the MEGA Wrench tightens the nut securely and easily by ratchet function.



ER NUT



C-SPANNER

Basic nut with surface treatment for friction reduction. C-Spanner is used for tightening.

*MEGA NUT is the recommended nut to achieve high accuracy and clamping force

COLLET CHUCK

BIG KAISER

MEGA E CHUCK

CLAMPING RANGE: ϕ .125"-.500" (ϕ 3-12mm)
 Exclusively for High Speed Finish End Milling

MAX
35,000
RPM

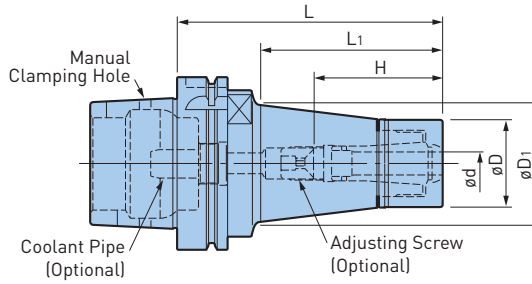
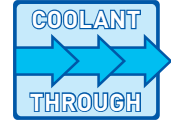

HSK A.3

Catalog Number	ϕd	ϕD	$\phi D1$	L	L1	H	Collet	Nut	Wrench	Max RPM	Weight (lbs.)	
HSK-A40-MEGA6E-60 \diamond	.125-.250 (3-6mm)	.984	1.02	2.36	.94	1.61	MEC6-□	MEN6	MGR25	35,000	.9	
			1.12	2.95	1.54	2.17					1.0	
-MEGA8E-65 \diamond	.125-.250 (3-8mm)	1.181	1.34	2.56	1.18	1.73	MEC8-□	MEN8	MGR30	35,000	1.0	
			1.34	2.95	1.57	2.13					1.1	
-MEGA10E-70 \diamond	.125-.375 (3-10mm)	1.378	1.38	2.76	1.38	1.89	MEC10-□	MEN10	MGR35	30,000	1.2	
			1.38	3.54	2.17	1.89-2.05					1.5	
-MEGA13E-70 \diamond	.125-.500 (3-12mm)	1.654	1.65	2.76	1.38	1.97	MEC13-□	MEN13	MGR42	30,000	1.4	
			1.65	3.54	2.17	2.64					1.8	
HSK-A50-MEGA6E-75	.125-.250 (3-6mm)	.984	1.12	2.95	1.46	1.46-1.69	MEC6-□	MEN6	MGR25	30,000	1.3	
-MEGA8E-75 \diamond	.125-.250 (3-8mm)	1.181	1.30	2.95	1.57	1.65	MEC8-□	MEN8	MGR30	30,000	1.5	
-MEGA10E-75 \diamond	.125-.375 (3-10mm)	1.378	1.50	2.95	1.57	1.89	MEC10-□	MEN10	MGR35	30,000	1.8	
-MEGA13E-75 \diamond	.125-.500 (3-12mm)	1.654	—	2.95	1.93	1.97	MEC13-□	MEN13	MGR42	30,000	2.0	
			—	3.94	2.91	1.97-2.17					2.4	
HSK-A63-MEGA6E-65 \diamond	.125-.250 (3-6mm)	.984	1.04	2.56	1.10	1.77	MEC6-□	MEN6	MGR25	30,000	2.0	
-90			1.18	3.54	2.01	1.46-1.77					2.2	
-105			1.30	4.13	2.60						2.4	
-120			1.42	4.72	3.23						2.6	
-135			1.54	5.31	3.90						2.7,000	3.1
-MEGA8E-67 \diamond	.125-.250 (3-8mm)	1.181	1.24	2.64	1.18		1.77	MEC8-□	MEN8	MGR30	30,000	2.0
-90			1.38	3.54	2.05	1.46-1.77	2.4					
-105			1.50	4.13	2.68	1.65-2.01	2.6					
-120			1.59	4.72	3.27		2.8,000					3.1
-135			1.73	5.31	3.94		2.7,000					3.5
-MEGA10E-75 \diamond	.125-.375 (3-10mm)	1.378	1.48	2.95	1.46	1.89	MEC10-□	MEN10	MGR35	30,000	2.4	
-90 \diamond			1.57	3.54	2.09	2.52					2.6	
-105			1.69	4.13	2.72	1.89-2.28					2.9,000	3.1
-120			1.81	4.72	3.35						2.8,000	3.3
-135			1.69	5.31	3.90						2.7,000	3.7
-MEGA13E-75 \diamond	.125-.500 (3-12mm)	1.654	1.73	2.95	1.22	1.93	MEC13-□	MEN13	MGR42	30,000	2.6	
-90 \diamond			.77	3.54	1.81	2.52					3.1	
-105			1.81	4.13	2.40	1.97-2.24					2.9,000	3.5
-120			1.87	4.72	3.03						2.8,000	4.0
-135			1.85	5.31	3.62						2.6,000	4.2

Catalog Number	ød	øD	øD1	L	L1	H	Collet	Nut	Wrench	Max RPM	Weight (lbs.)
HSK-A100-MEGA6E-75 ❖	.125-.250 (3-6mm)	1.984	1.10	2.95	1.30	1.81	MEC6-□	MEN6	MGR25	24,000	5.5
-90			1.16	3.54	1.89	1.46-1.77					5.7
-105			1.28	4.13	2.48						6.0
-120			1.38	4.72	3.07						6.2
-135			1.48	5.31	3.66						6.4
-165			1.69	6.50	4.84						7.1
-MEGA8E-75 ❖	.125-.250 (3-8mm)	1.181	1.30	2.95	1.30	1.81	MEC8-□	MEN8	MGR30	24,000	5.5
-90			1.36	3.54	1.89	1.65-2.01					5.7
-105			1.46	4.13	2.48						6.2
-120			1.56	4.72	3.07						6.4
-135			1.67	5.31	3.66						6.8
-165			1.87	6.50	4.84						7.5
-MEGA10E-80 ❖	.125-.375 (3-10mm)	1.378	1.48	3.15	1.50	2.01	MEC10-□	MEN10	MGR35	22,000	5.7
-90 ❖			1.56	3.54	1.89	2.40					6.0
-105			1.65	4.13	2.48	1.89-2.28					6.4
-120			1.75	4.72	3.07						6.8
-135			1.85	5.31	3.66						7.3
-165			2.07	6.50	4.84						8.2
-MEGA13E-90 ❖	.125-.500 (3-12mm)	1.654	1.81	3.54	1.89	1.97	MEC13-□	MEN13	MGR42	20,000	6.4
-105			1.91	4.13	2.48	1.97-2.40					6.8
-120			2.03	4.72	3.07						7.3
-135			2.13	5.31	3.66						7.9
-165			2.32	6.50	4.84						9.3

- MEGA E NUT is included, coolant pipe, collet, wrench and adjusting screw must be ordered separately
- Weight includes nut but not collet
- Center through coolant supply is available
- Please note that the practical spindle speed may be considerably influenced by the machine rigidity and tool balance, when using, slowly ramp up to the appropriate speed starting from slow speeds
- "H" indicates the adjustment length with an adjusting screw
- Adjusting screws cannot be used with models marked ❖

ACCESSORIES



MEGA PERFECT GRIP

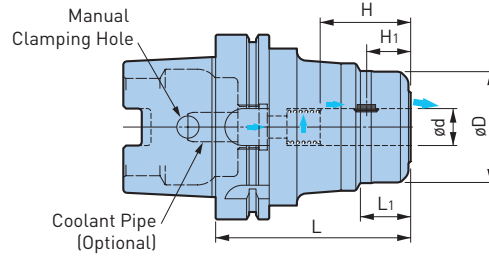
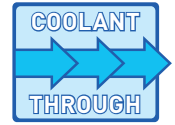

Catalog Number	ød	øD	L	L1	H	H1	Wrench	Weight (lbs.)
HSK-A63-MEGA16DPG-90	16mm	1.811	3.543	.945	1.850	.906	MGR46L	3.5
-MEGA20DPG-100	20mm	2.362	3.543	1.063	1.929	.945	MGR60L	4.4
HSK-A100-MEGA.750DPG-4	.750	2.362	4.000	1.072	1.929	.913	MGR60L	9
-MEGA1.000DPG-4	1.000	2.756	4.000	1.318	2.165	1.024	MGR70L	9.9
-MEGA1.250DPG-4.5	1.250	3.150	4.500	1.622	2.244	1.102	MGR80L	11
-MEGA20DPG-105	20mm	2.362	4.134	1.063	1.929	.945	MGR60L	9
-MEGA25DPG-105	25mm	2.756	4.134	1.299	2.165	.906	MGR70L	9.9
-MEGA32DPG-115	32mm	3.150	4.528	1.614	2.322	.906	MGR80L	11
HSK-A125-MEGA1.000DPG-4.5	1.000	2.756	4.500	1.299	2.165	1.024	MGR70L	14
-MEGA1.250DPG-5	1.250	3.150	5.000	1.622	2.244	1.102	MGR80L	15.5
-MEGA16DPG-135	16mm	1.811	5.315	.945	1.850	.906	MGR46L	13
-MEGA20DPG-135	20mm	2.362	5.315	1.063	1.929	.945	MGR60L	14.7
-MEGA25DPG-135	25mm	2.756	5.315	1.299	2.165	.906	MGR70L	16
-MEGA32DPG-135	32mm	3.150	5.315	1.614	2.322	.906	MGR80L	17.2

- Key grip and spring are included, wrench must be ordered separately
- CYLINDRICAL SHANK WITH FLAT SECTION JIS B 4005 (ISO3338-2) is required, for inch shank refer to Pg. 65, for metric shank refer to Pg.121
- H1 is the dimension from the center of the Key Grip to the front end of the chuck
- When coolant supply is from the cutting edge a seal bush is necessary, use instead of the spring; seal bush must be ordered separately

CAUTION

Always replace worn or damaged Key Grips immediately for safe operation.

INCH

Clamping ø	Key Grip (2 pcs.)	Spring
.750	PKG.750-2P	PSP1823
1.000	PKG1.000-2P	PSP2420
1.250	PKG1.250-2P	PSP3128

- Spare Key Grips are available in 2 pcs. per set

METRIC

Clamping ø	Key Grip (2 pcs.)	Spring
ø16	PKG16-2P	PSP1519
ø20	PKG20-2P	PSP1823
ø25	PKG25-2P	PSP2420
ø32	PKG32-2P	PSP3128

- Spare Key Grips are available in 2 pcs. per set

NEW Hi-POWER MILLING CHUCK

CLAMPING RANGE: ϕ .750"-2.000" (ϕ 20-42mm) For Heavy Duty End Milling

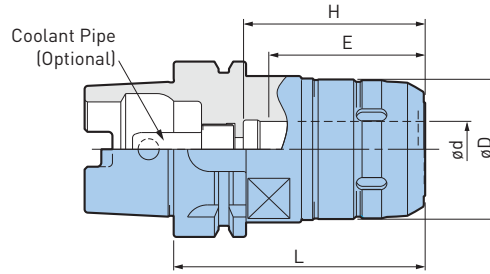
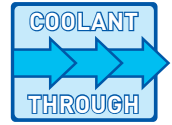

HSK A.3

Catalog Number	ϕd	ϕD	L	H	Min Clamping Length E	Wrench	Weight (lbs.)
HSK-A40-HMC20S-85	20mm	1.969	3.35	2.60	2.20	FK45-50L	2.0
HSK-A50-HMC20S-90	20mm	1.969	3.54	2.60	2.20	FK45-50L	2.6
-HMC32S-115◆	32mm	2.44	4.53	2.72		FK58-62L	3.5
HSK-A63-HMC20S-90	20mm	1.969	3.54	2.56	2.20	FK45-50L	3.3
-120●			4.72	3.35			4.2
-HMC25S-100	25mm	2.323	3.94	2.95	2.24	FK58-62L	4.2
-135❖			5.31	2.60-2.99			5.5
-HMC32S-110	32mm	2.677	4.33	3.35	2.52	FK68-75L	5.1
-135●			5.31	3.54			5.7
-165❖			6.50	3.11-3.50			7.1
HSK-A100-HMC20S-105	20mm	1.969	4.13	2.87	2.20	FK45-50L	6.6
-135■			5.31	3.35			7.7
-165❖			6.50	2.72-3.11			9.0
-HMC25S-105	25mm	2.323	4.13	2.87	2.24	FK58-62L	7.3
-135■			5.31	3.54			8.6
-165❖			6.50	2.99-3.39			10.6
-HMC32S-115	32mm	2.677	4.53	3.27	2.83	FK68-75L	8.6
-135			5.31	4.06			9.7
-165■			6.50	4.13			11.0
-200❖			7.87	3.54-3.94			14.1
-300❖			11.81				20.5
-HMC42S-115	42mm	3.346	4.53	3.27	2.87	FK80-90L	10.8
-135			5.31	4.06			12.1
-165■			6.50	4.21			15.0
HSK-A125-HMC.750J-4	.750	2.36	4.09	2.64	2.28	FK58-62	12.1
-HMC1.000J-5	1.000	2.44	5.09	3.63	2.64		12.3
-HMC1.250J-5	1.250	3.15			2.83	FK80-90	15.0
-HMC1.500J-5	1.500	3.90			2.87	FK92-100	18.0
-HMC2.000J-6	2.000	4.13			6.09	4.54	3.50

- Wrench and axial adjusting screw must be ordered separately
- When using center through coolant:
 - Set screw with sealing compound applied (standard accessory) should be used to plug an air bleeding hole
 - Oil hole type should be chosen when straight collet is required
- "H" dimension is the Max tool shank length that can be inserted into the holder
- Optional adjusting screw can be used with models marked ❖
- Straight collet model C32-□□ can only be used with models marked ◆
- M8 hex screw is required with models marked ● please contact us if using for center through applications
- M12 hex screw is required with models marked ■
- Through tool coolant for HSK-A125 is Jet type delivery

ACCESSORIES



NEW Hi-POWER MILLING CHUCK

CLAMPING RANGE: $\phi 12\text{mm}$

A slim yet highly rigid milling chuck with $\phi 32$ outer diameter nut for reduced interference.

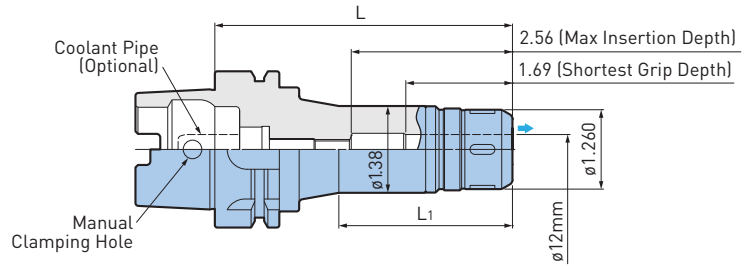
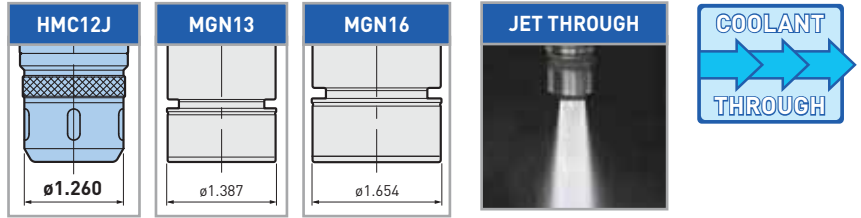

Catalog Number	L	L1	Wrench	Weight (lbs.)
HSK-A63-HMC12J-90	3.54	2.08	FK31-33	2.4
-120●	4.72	2.75		3.1

- Wrench must be ordered separately
- M8 hex screw is required with models marked ● please contact us if using for center through applications



SUPER SLIM TYPE

CLAMPING RANGE: $\varnothing 3$ -12mm

For Drills, Reamers, Ball Mills, End Mills, Diamond Reamers & Grinding Tools



HSK A.3

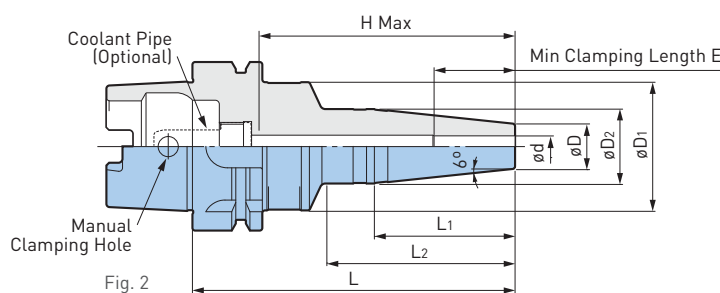
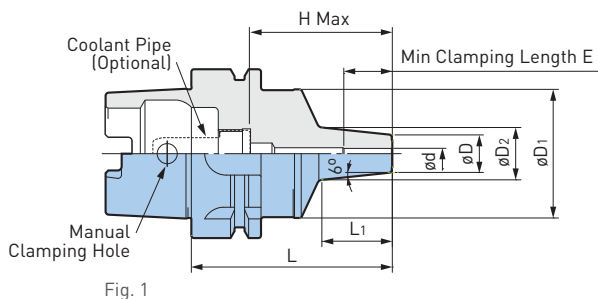

Catalog Number	Fig.	$\varnothing d$	$\varnothing D$	$\varnothing D1$	$\varnothing D2$	L	L1	L2	E	H Max	Max RPM	Weight (lbs.)
HSK-A40-HDC4S-65	1	4mm	.551	1.30	.83	2.559	1.10	—	.75	1.93	35,000	.73
HSK-A50-HDC4S-75	1	4mm	.551	1.57	.83	2.953	1.22	—	.75	2.17	35,000	1.8
HSK-A63-HDC3S-90	1	3mm	.551	1.89	.83	3.543	1.69	—	.63	2.68	30,000	2.4
-HDC4S-75		.79			2.953	1.02	—	.75	2.09	30,000	2.2	
-120	1	4mm	.551	1.89	1.02	4.724	2.24	2.83	.98	3.86	30,000	2.4
-HDC6S-120		2.76						3.86		30,000	2.4	
-150	1	6mm	.551	1.89	1.02	4.724	2.24	3.35	.98	5.04	28,000	2.9
-HDC8S-120		2.76						3.74		30,000	2.7	
-150	2	8mm	.669	1.89	1.10	4.724	2.05	3.35	1.22	4.92	28,000	2.9
-HDC10S-120		2.76	3.70		30,000	2.7						
-150	2	10mm	.748	1.89	1.18	4.724	2.05	3.43	1.30	4.88	25,000	3.1
-HDC12S-120		2.76	3.66		30,000	2.7						
-150	2	12mm	.827	1.89	1.26	4.724	2.05	3.43	1.42	4.84	25,000	3.1
-HDC12S-120		2.76	3.66		30,000	2.7						

- Coolant Pipe must be ordered separately
- Adjusting screws cannot be used

CAUTION

Use only cutting tools that have a shank tolerance of h6. Do not use with cutting tools made with a flat on the shank (ie: Weldon type shank). Roughing end mills are not recommended for use with Hydraulic Chucks. Do not tighten the clamping screw without first inserting a cutting tool into the tool holder. Always insert the cutting tool into the hydraulic tool holder beyond min. clamping length "E".

JET COOLANT TYPE

CLAMPING RANGE: $\varnothing 4\text{-}32\text{mm}$

Coolant Holes Through Body of Holder

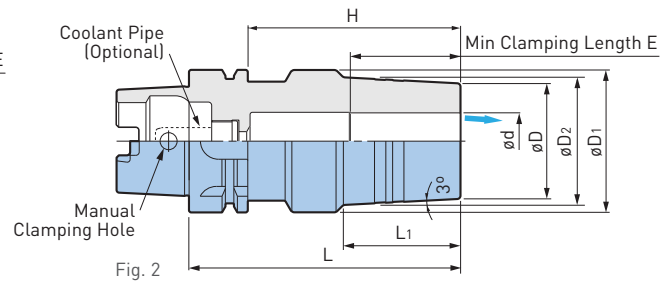
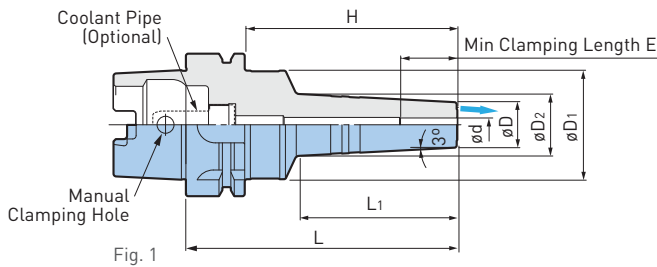
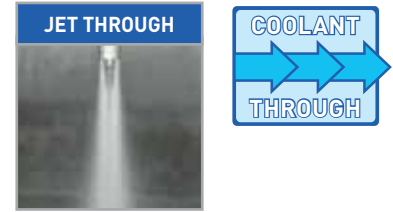

Catalog Number	Fig.	$\varnothing d$	$\varnothing D$	$\varnothing D1$	$\varnothing D2$	L	L1	H	E	Weight (lbs.)
HSK-A63-HDC4J-75	1	4mm	.787	1.89	.91	2.95	1.14	2.09	.75	2.2
-HDC6J-120		6mm			1.10			3.86	.98	
-HDC8J-120		8mm	1.18		3.74		1.18	2.6		
-HDC10J-120		10mm	.945		1.26		3.70		1.26	2.9
-HDC12J-120		12mm	1.024		1.34		3.66	1.38	2.9	
-HDC16J-120		16mm	1.339		1.69		3.62	1.65		3.3
-HDC20J-120		20mm	1.496				6.58		3.3	
-HDC25J-120		2	25mm		2.008		2.48	2.24	4.72	1.97
-HDC32J-120	32mm		2.362	2.72	—	2.09	2.20	5.1		

- Coolant Pipe must be ordered separately
- Adjusting screws cannot be used

CAUTION

Use only cutting tools that have a shank tolerance of h6. Do not use with cutting tools made with a flat on the shank (ie: Weldon type shank). Roughing end mills are not recommended for use with Hydraulic Chucks. Do not tighten the clamping screw without first inserting a cutting tool into the tool holder. Always insert the cutting tool into the hydraulic tool holder beyond min. clamping length "E".

HYDRAULIC CHUCK

BIG KAISER

CLAMPING RANGE: ϕ .750"-1.250" (ϕ 6-32mm)

For Drills, Reamers, Ball Mills, End Mills, Diamond Reamers & Grinding Tools

MAX
17,000
RPM

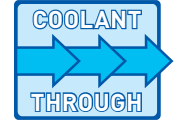

HSK A.3

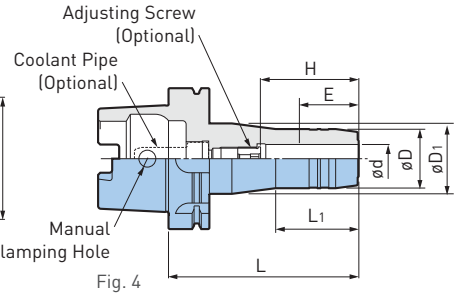
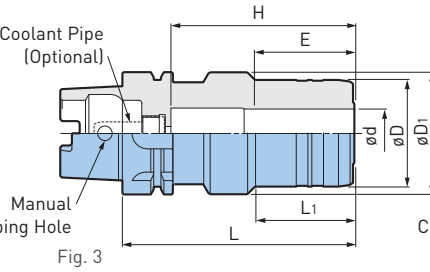
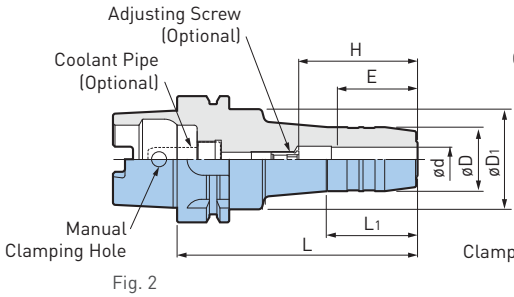
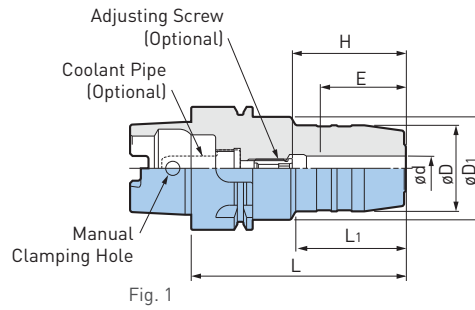

Catalog Number	Fig.	ϕd	ϕD	$\phi D1$	L	L1	H	Min Clamping Length E	Adjusting Screw	Max RPM	Weight (lbs.)				
HSK-A40-HDC6-70	1	6mm	1.020	1.32	2.76	1.42	1.10-1.42	1.10	HDA6-05013	17,000	1.0				
-HDC8-70		8mm	1.100						1.1						
-HDC10-75		10mm	1.180						HDA8-06013		1.1				
-HDC12-80		12mm	1.260						1.2						
HSK-A50-HDC6-75	1	6mm	1.020	1.64	2.95	1.56	1.10-1.46	1.10	HDA6-05013	17,000	1.5				
-HDC8-75		8mm	1.100						HDA8-06013		1.5				
-HDC10-80		10mm	1.180						HDA10-08015		1.5				
-HDC12-85		12mm	1.260								1.8				
-HDC16-90 \blacklozenge		16mm	1.500						3.54		1.89	1.69-2.01	1.69	13,000	2.0
-HDC20-90 \blacklozenge		20mm	1.650								2.52	2.0			
-HDC25-90 \blacklozenge		25mm	2.170						2.48		.91	2.44	2.05	10,000	2.9
HSK-A63-HDC.750-4	2	.750	1.654	—	4.00	2.00	1.69-2.76	1.69	HDA16-12037	13,000	3.5				
-HDC1.000-4	3	1.000	2.165	—	4.00	1.25	2.05-3.15	2.05	HDA25-16039	13,000	4.6				
-HDC1.250-4.5	3	1.250	2.677	—	4.00	1.25	2.20-3.15	2.20	HDA25-16039	12,000	5.3				
-HDC6-70 \blacklozenge	2	6mm	1.020	1.97	2.76	.99	1.81	1.10	—	17,000	2.2				
-120									HDA6-05032		2.6				
-150											3.1				
-HDC8-70 \blacklozenge											—	2.2			
-120									HDA8-06032		2.9				
-150											1.1				
-HDC10-80 \blacklozenge		—	2.4												
-120		HDA10-08032	2.9												
-150			3.5												
-HDC12-85 \blacklozenge			—		2.4										
-120		1.50	HDA12-10025		3.1										
-150					3.5										

Catalog Number	Fig.	ød	øD	øD1	L	L1	H	Min Clamping Length E	Adjusting Screw	Max RPM	Weight (lbs.)
HSK-A63-HDC14-85 ❖	2	14mm	1.340	1.97	3.35	1.57	2.36	1.50	—	15,000	2.6
-120					4.72	1.77	1.50-2.28		HDA12-10025		3.1
-150					5.90						3.7
-HDC16-90 ❖		16mm	1.500		3.54		2.56	1.69	—	13,000	2.9
-120					4.72	1.81	2.28-2.68		HDA16-12015		3.3
-150					5.90		1.69-2.68		HDA16-12037		4.2
-HDC18-90 ❖		18mm	1.570		3.54		2.56	1.69	—	13,000	2.9
-120					4.72	1.81	2.28-3.68		HDA20-16015		3.5
-150					5.90		1.69-2.68		HDA25-16039		4.4
-HDC20-90 ❖		20mm	1.650		3.54		2.56	1.69	—	13,000	2.9
-120					4.72	1.89	2.28-2.68		HDA20-16015		3.5
-150					5.90		1.69-2.68		HDA25-16039		4.4
-HDC25-120 ❖	3	25mm	2.170	2.48	4.72	2.01	3.74	2.05	—	12,000	4.6
-HDC32-125 ❖		32mm	2.360	2.95	4.92	2.32	3.94	2.20	—	12,000	5.3
HSK-A100-HDC.750-4	2	.750	1.654	—	4.00	2.00	1.69-2.76	1.69	HDA16-12037	13,000	6.0
-HDC1.000-4	3	1.000	2.480	—	4.00	3.54	2.05-3.15	2.05	HDA25-16039	13,000	7.3
-HDC1.250-4.5	3	1.250	2.717	—	4.50	3.58	2.20-3.15	2.20	HDA25-16039	12,000	8.2
-HDC6-75 ❖	4	6mm	1.020	1.97	2.95	1.02	1.81	1.10	—	17,000	5.3
-120					4.72	1.73	1.10-1.89		HDA6-05032		5.7
-165					6.50						6.4
-HDC8-75 ❖		8mm	1.100		2.95	1.02	1.81	1.10	—	15,000	5.3
-120					4.72	1.73	1.10-1.89		HDA8-06032		5.7
-165					6.50						6.6
-HDC10-90 ❖		10mm	1.188		3.54	1.65	2.40	1.30	—	15,000	5.5
-120					4.72	1.77	1.30-2.09		HDA10-08032		6.0
-165					6.50						6.8
-HDC12-95 ❖		12mm	1.260		3.74		2.48	1.50	—	13,000	5.5
-120					4.72	1.85	1.50-2.28		HDA12-10025		6.0
-165					6.50				HDA12-10032		6.8
-HDC16-100 ❖		16mm	1.500		3.94		2.68	1.69	—	13,000	5.7
-135					5.31	2.09	1.69-2.68		HDA16-12030		6.6
-165					6.50				HDA16-12037		7.3
-HDC20-105 ❖		20mm	1.650		4.13		2.87	1.69	—	13,000	6.0
-135					5.31	2.32	2.28-2.68		HDA20-16015		6.8
-165					6.50		1.69-2.68		HDA25-16039		7.9
-HDC25-110 ❖	25mm	2.240	2.48	4.33	2.44	3.07	2.05	—	12,000	7.3	
-HDC32-110 ❖	32mm	2.520	2.95	4.33	2.44	3.07	2.20	—	12,000	8.2	

- Coolant pipe must be ordered separately
- "H" indicates the adjustment length with an adjusting screw
- "H" dimension is the Max tool shank length that can be inserted into the holder
- Do not attempt to balance before first consulting BIG KAISER
- In case the projection length needs to be adjusted from the shank side, add the letter "W" to adjusting screw model number for hexagon sockets on both sides (ex: HDA6-05020W)
- Adjusting screws cannot be used with models marked ❖
- Straight collet cannot be used with models marked ◆

CAUTION ⚠

Use only cutting tools that have a shank tolerance of h6 (see table Pg. 26). Do not use with cutting tools made with a flat on the shank (ie: Weldon type shank). Roughing end mills are not recommended for use with HYDRAULIC CHUCKS. Do not tighten the clamping screw without first inserting a cutting tool into the tool holder. Always insert the cutting tool into the hydraulic tool holder beyond min. clamping length "E".

ACCESSORIES



SHRINK FIT HOLDER

CLAMPING RANGE: $\varnothing 4$ -20mm

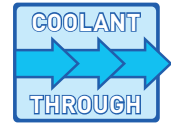

HSK A.3

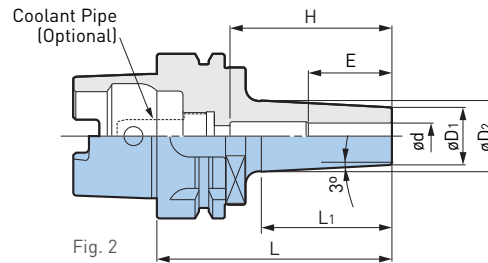
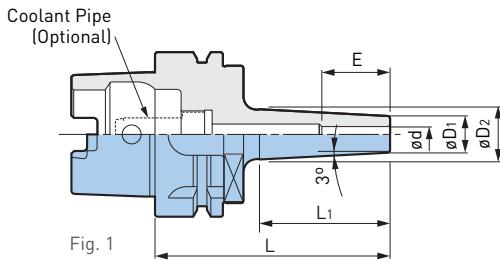

Catalog Number	Fig.	$\varnothing d$	$\varnothing D1$	$\varnothing D2$	L	L ₁	Min Clamping Length E	Max Insertion Length H	Weight (lbs.)
HSK-A63-SRC4-90 ❖	1	4mm	.394	.58	3.54	1.81	.63	(2.68)	1.9
-SRC6-90		6mm	.551	.75		2.01		(2.68)	2.0
-150				.98	5.91	4.25		(5.04)	2.3
-SRC8-90	2	8mm	.709	.91	3.54	2.01	1.02	(2.68)	2.0
-150				1.14	5.91	4.33		(5.04)	2.5
-SRC10-90		10mm	.866	1.06	3.54	2.01	1.26	2.44	2.2
-150				1.32	5.91	4.37		2.8	
-SRC12-90		12mm	.945	1.14	3.54	2.01	1.42	2.56	2.2
-150				1.42	5.91	4.41		2.83	2.9
-SRC16-90		16mm	1.102	1.30	3.54	2.01	1.50	2.56	2.2
-165				1.59	6.50	4.69		3.15	3.7
-SRC20-90		20mm	.945	1.56	3.54	2.09	1.65	2.56	2.4
-165				1.83	6.50	4.80		3.94	4.2

- Coolant pipe must be ordered separately
- "H" dimensions in () are reference length up to the coolant pipe
- Use carbide cutter within a tolerance of h6
- Use carbide cutter within a tolerance of h5 with models marked ❖
- Center through coolant supply is available with tools with oil holes

CAUTION ⚠

Please refer to the operation manual of heating/cooling equipment, as some equipment may not be compatible.

SHRINK FIT HOLDER—SLIM TYPE

CLAMPING RANGE: $\varnothing 6$ -12mm

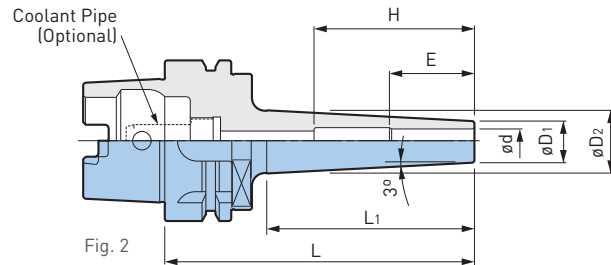
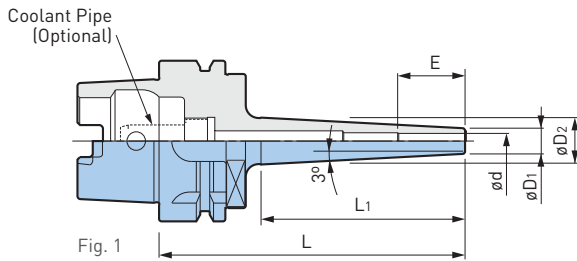
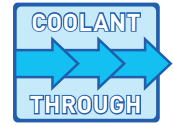

Catalog Number	Fig.	$\varnothing d$	$\varnothing D1$	$\varnothing D2$	L	L ₁	Min Clamping Length E	Max Insertion Length H	Weight (lbs.)		
HSK-A63-SRC6S-120	1	6mm	.394	.73	4.72	3.19	1.02	(3.85)	2.0		
-165				.89	6.50	4.76		(5.63)	2.2		
-SRC8S-120	2	8mm	.512	.85	4.72	3.19		(3.85)	2.0		
-165				1.02	6.50	4.84		(5.63)	2.4		
-SRC10S-120				10mm	.630	.96	4.72	3.19	1.26	2.44	2.2
-165						1.14	6.50	4.84			2.4
-SRC12S-120	12mm	.748	.748	1.08	4.72	3.19	1.42	2.83	2.2		
-165				1.26	6.50	4.92			2.6		

- Coolant pipe must be ordered separately
- "H" dimensions in () are reference length up to the coolant pipe
- Use carbide cutter within a tolerance of h6
- Use carbide cutter within a tolerance of h5 with models marked ❖
- Center through coolant supply is available with tools with oil holes

CAUTION

Please refer to the operation manual of heating/cooling equipment, as some equipment may not be compatible.



END MILL HOLDER

CLAMPING RANGE: ϕ .750"-2.000" (ϕ 20-50mm)

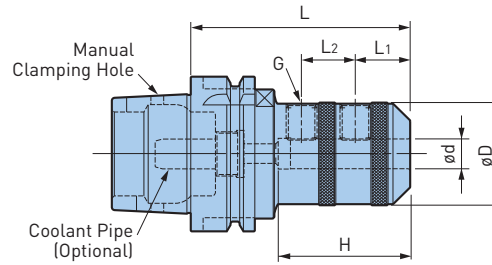
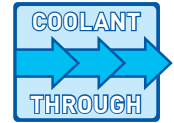

A.3
HSK

Catalog Number	ϕd	ϕD	L	L1	L2	H	G	Weight (lbs.)
HSK-A63-ISL20-80	20mm	2.047	3.15	.98	—	2.13	M16	3.3
-ISL25-105	25mm	2.559	4.13	.94	.98	2.36	M18	5.1
-ISL32-115	32mm	2.835	4.53		1.10	2.52	M20	6.0
HSK-A100-ISL20-90	20mm	2.047	3.54	.98	—	2.13	M16	7.5
-135			5.31					9.0
-195			7.68					11.0
-ISL25-105	25mm	2.559	4.13	.94	.98	2.36	M18	9.5
-135			5.31					11.0
-195			7.68					14.1
-ISL32-125	32mm	2.835	4.92	.94	1.10	3.54	M20	10.8
-165			6.50					13.9
-195			7.68					15.9
-ISL40-125	40mm	3.543	4.92	1.18	1.26	3.54	M20	12.8
-165			6.50					17.9
-210			8.27					22.5
-ISL50-135	50mm	3.917	5.31	1.38	1.38	3.54	M24	14.8
-165			6.50					18.7
-210			8.27					24.2
HSK-A125-EM.750-4	.750	1.750	4.00	1.00	—	2.54	5/8"-18	10.4
-EM1.000-5	1.000	2.252	5.00	1.13	1.00	3.13	3/4"-16	12.2
-EM1.250-5	1.250	2.750						13.6
-EM1.500-5	1.500	2.750						13.1
-EM2.000-6	2.000	3.500	6.00	1.38	1.38	4.33	1"-14	17.1

- Coolant pipe must be ordered separately
- Center through coolant supply is available
- For high speed applications MEGA DOUBLE POWER CHUCKS are recommended instead of End Mill Holders

ACCESSORIES



CAUTION

BIG genuine side lock screws must be used as they are made to an exclusive design and different from other screws on the market.

SHELL/FACE MILL HOLDER

For Cutters the Require a Coolant Hole Through The Pilot

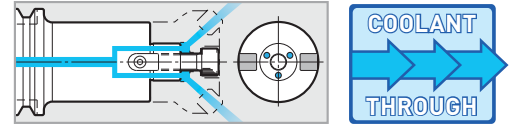

HSK A.3

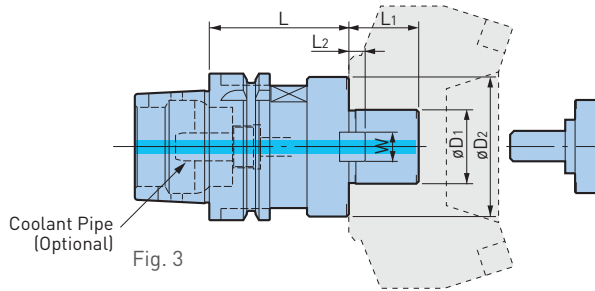
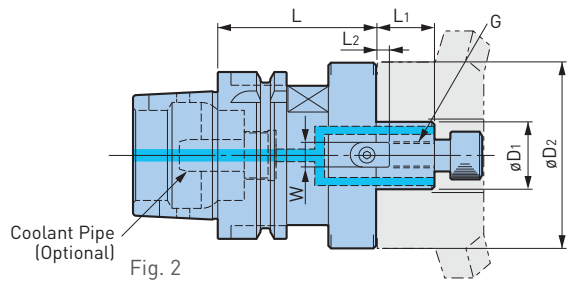
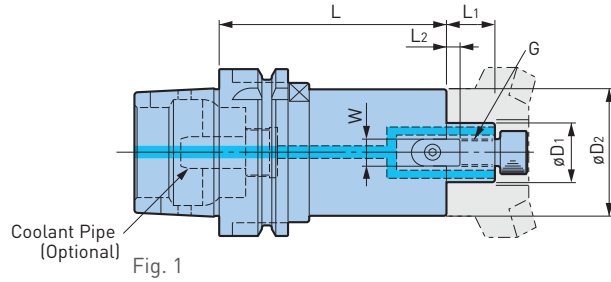

Catalog Number	Fig.	øD1	øD2	L	L1	Drive Keys		G	Weight (lbs.)
						L	W		
HSK-A40-FMA25.4-50	3	25.4mm	1.969	1.97	.87	.20	.37	M12	1.3
HSK-A50-FMH25.4-50-60	2	25.4mm	1.969	2.36	.87	.197	.374	M12	2.2
-FMH22-47-60		22mm	1.850	2.362	.709	.197	.394	M10	1.8
-90				3.543	.787	.236	.472	M12	2.6
-FMH27-60-60		27mm	2.362	2.362	.787	.236	.472	M12	2.2
-90				3.543	.787	.236	.472	M12	2.9
HSK-A63-FMH16-37-45		1	16mm	1.457	1.77	.63	.20	.31	M8
-FMH22-47-60	22mm		1.850	2.36	.71	.20	.39	M10	2.9
-90				3.54	.71	.20	.39	M10	3.7
-150				5.91	.71	.20	.39	M10	5.5
-FMH22-60-60	2	22mm	2.362	2.36	.71	.20	.39	M10	3.1
-90				3.54	.71	.20	.39	M10	4.0
-FMH27-60-60	2	27mm	2.362	2.36	.79	.24	.47	M12	3.5
-90				3.54	.79	.24	.47	M12	5.1
-FMH22.225-47-60	1	22.225mm	1.850	2.36	.67	.14	.31	M10	2.9
-90				3.54	.67	.14	.31	M10	3.7
-FMH25.4-70-60	2	25mm	2.756	2.36	.87	.20	.37	M12	4.0
-90				3.54	.87	.20	.37	M12	5.5
-150				5.91	.87	.20	.37	M12	9.0
-FMH31.75-76-60	2	31.75mm	2.992	2.36	1.18	.28	.50	M16	4.4
-90				3.54	1.18	.28	.50	M16	6.0
-FMA25.4-60	3	25.4mm	1.969	2.36	.87	.20	.37	M12	2.9
-90				3.54	.87	.20	.37	M12	3.7
-FMA31.75-60	3	31.75mm	2.362	2.36	1.18	.28	.50	M16	3.3

Catalog Number	Fig.	øD1	øD2	L	L1	Drive Keys		G	Weight (lbs.)
						L	W		
HSK-A100-FMH22-47-105	1	22mm	1.850	4.13	.71	.20	.39	M10	7.5
-150				5.91					8.8
-200				7.87					10.4
-250				9.84					11.9
-FMH22-60-60	1	22mm	2.362	2.36	.71	.20	.39	M10	6.4
-105				4.13					8.6
-150				5.91					11.9
-200				7.87					13.4
-250	9.84	15.9							
-FMH27-60-60	1	27mm	2.362	2.36	.79	.24	.47	M12	6.4
-90				3.54					8.2
-150				5.91					11.0
-200				7.87					13.0
-250	9.84	15.4							
-FMH27-76-60	1	27mm	2.992	2.36	.79	.24	.47	M12	7.1
-90				3.54					9.5
-150				5.91					14.3
-FMH32-96-60	2	32mm	3.780	2.36	.87	.28	.55	M16	8.4
-90				3.54					12.1
-150				5.91					19.6
-FMH40-100-75	2	40mm	3.937	2.95	1.02	.33	.63	M20 (MBA-M20)	10.8
-105				4.13					15.0
-FMH22.225-47-105	1	22.225mm	1.850	4.13	.67	.14	.31	M10	7.5
-150				5.91					8.8
-200				7.87					10.4
-250				9.84					11.7
-FMA25.4-105	3	25.4mm	1.969	4.13	.87	.20	.37	M12	9.9
-135				5.31					11.7
-195				7.68					15.6
-FMA31.75-105	3	31.75mm	2.362	4.13	1.18	.28	.50	M16	10.6
-135				5.31					12.3
-195				7.68					15.4
-FMA38.1-90	3	38.1mm	3.150	3.54	1.34	.35	.63	M20	10.8
-FMA50.8-75	3	50.8mm	3.937	2.95	1.42	.39	.75	M24	11.7
HSK-A125-FMH22-47-50	1	22mm	1.930	1.97	.71	.20	.39	M10	9.5
-FMH32-76-60	1	32mm	3.070	2.36	.87	.28	.55	M16	11.2
-FMH32-96-105	1	32mm	3.780	4.13					17.9
-SMC1.000-4	1	1.000	2.189	4.00	.69	.20	.37	1/2"-20	12.5
-SMC1.250-4	1	1.250	2.752	4.00		.28	.49	5/8"-18	13.6
-SMC1.500-4	1	1.500	3.626	4.00		.94	.35	.62	3/4"-16

- Lock screw is included, coolant pipe must be ordered separately
- A clamping screw with oil hole must be ordered separately for use with center through coolant/air

CAUTION 

For high speed applications, Shell Mill Holders should be balanced together with the cutters.

ACCESSORIES



SMART DAMPER MILLING—FACE MILL ARBOR TYPE

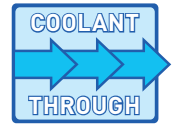

HSK A.3

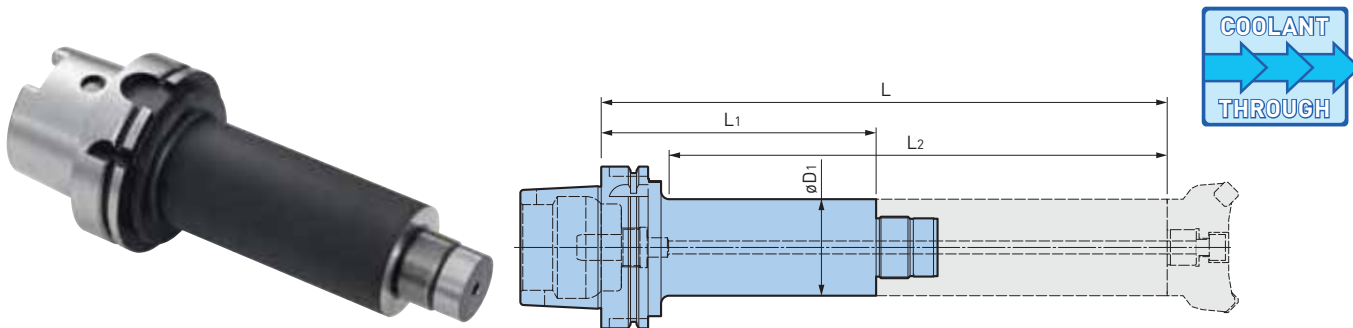
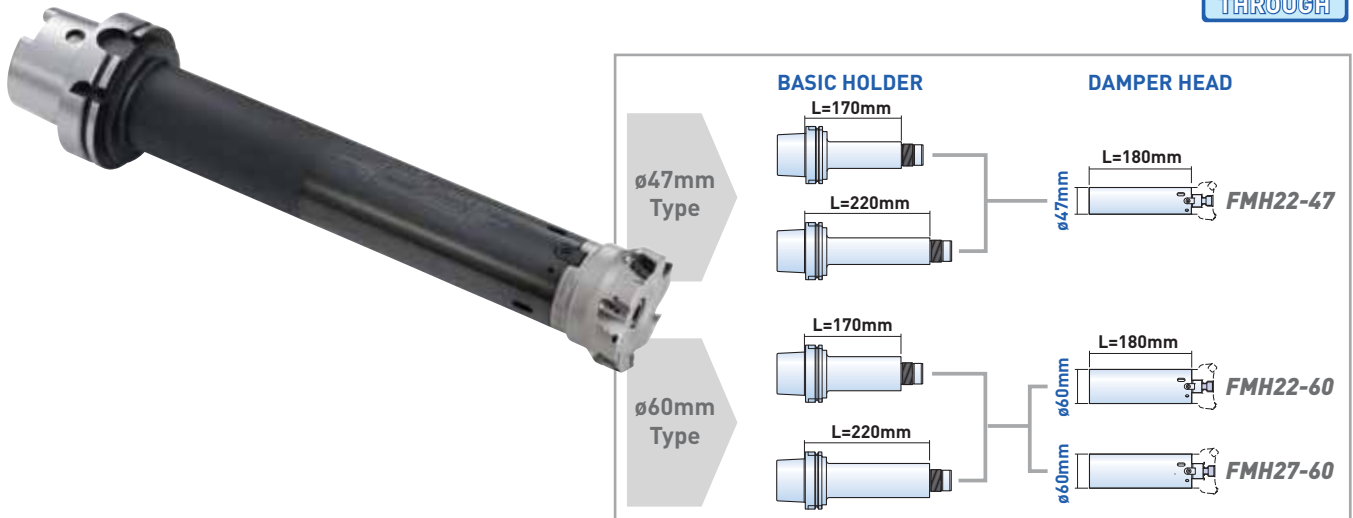

Catalog Number	øD1	L	L1	L2	Weight (lbs.)	Damper Head Model
HSK-A100-SDF36-47-170	47mm	13.780	6.693	12.205	9.7	FMH□□DP-47
-47-220		15.748	8.661	14.173	11.0	
-60-170	60mm	13.780	6.693	12.205	12.1	FMH□□DP-60
-60-220		15.748	8.661	14.173	14.3	
HSK-A125-SDF36-47-250	47mm	16.929	9.843	14.96	15.2	FMH□□DP-47
-60-250	60mm				17.6	FMH□□DP-60

• Coolant pipe must be ordered separately

SMART DAMPER MILLING—DAMPER HEAD

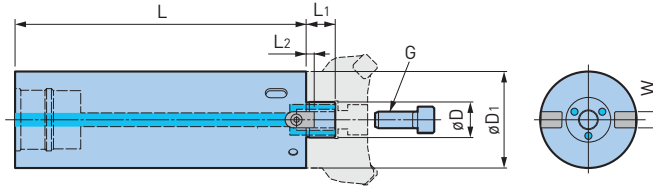
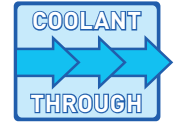

Catalog Number	øD	øD1	L	L1	L2	W	G	Weight (lbs.)	C-Spanner Model
SDF36-FMH22DP-47-180	22mm	1.850	7.087	.709	.197	.394	M10	6.6	FK45-50L
-60-180	22mm	2.362	7.087	.709	.197	.394	M10	9.9	FK58-62L
-FMH27DP-60-180	27mm	2.362	7.087	.787	.236	.472	M12	9.9	
SDF36-SMC.750DP-47-180	.750	1.850	7.087	.689	.160	.313	3/8"-24	6.6	FK45-50L
-SMC1.000DP-60-180	1.000	2.362	7.087	.689	.220	.375	1/2"-20	9.9	FK58-62L

- Hook wrench and cutter clamping screw are included
- The weight does not include the cutter
- Refer to the operation manual regarding the mounting method to the basic holder
- If the provided clamping screw is not compatible, separately select one from the clamping screw table on Pg. 390
- øC indicates the smallest mounting surface diameter of the cutter that can be mounted on the arbor, be careful when using a cutter with the mounting diameter considerably smaller than the cutting diameter, as it may not fit



MEGA SYNCHRO TAPPING HOLDER

TAPPING RANGE: No.6-AU3/4 (M2-M20)

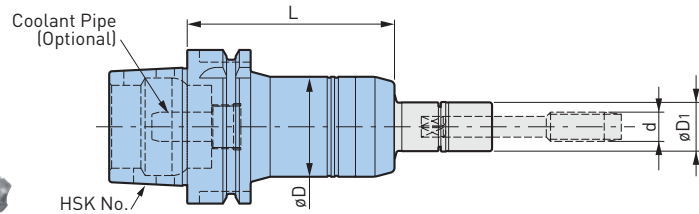
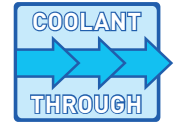
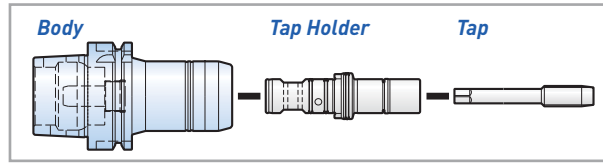

HSK A.3

Catalog Number	Tapping Range d* (Inch)	Tapping Range d* (Metric)	øD	øD1	L	Wrench	Weight (lbs.)
HSK-A40-MGT6-80	No.2-No.12	M2-M6	1.42	.63	3.15	MGR16	1.3
-MGT12-85	AU1/4-AU7/16	M6-M12	1.61	.79	3.35	MGR20L	1.5
HSK-A50-MGT6-85	No.2-No.12	M2-M6	1.42	.63	3.35	MGR16	1.8
-MGT12-85	AU1/4-AU7/16	M6-M12	1.61	.79	3.35	MGR20L	2.0
-MGT20-125	AU1/2-AU3/4 AP1/8-AP1/4	M12-M20	2.13	1.18	4.92	MGR30L	3.5
HSK-A63-MGT6-85	No.2-No.12	M2-M6	1.42	.63	3.35	MGR16	2.4
-MGT12-85	AU1/4-AU7/16	M6-M12	1.61	.79	3.35	MGR20L	2.6
-MGT20-110	AU1/2-AU3/4 AP1/8-AP1/4	M12-M20	2.13	1.18	4.33	MGR30L	4.0
HSK-A100-MGT6-95	No.2-No.12	M2-M6	1.42	.63	3.74	MGR16	5.7
-MGT12-95	AU1/4-AU7/16	M6-M12	1.61	.79	3.74	MGR20L	5.9
-MGT20-115	AU1/2-AU3/4 AP1/8-AP1/4	M12-M20	2.13	1.18	4.53	MGR30L	7.3
HSK-A125-MGT12-105	AU1/4-AU7/16	M6-M12	1.61	.79	3.74	MGR20L	9.4
-MGT20-120	AU1/2-AU3/4 AP1/8-AP1/4	M12-M20	2.13	1.18	4.53	MGR30L	10.6

*AU3/8 is included in the MGT20 series

- Coolant pipe, tap holder and wrench must be ordered separately
- Rigid tapping function is required on the machine tool

ACCESSORIES



CAUTION

Cannot be used with machining center without synchronized tapping function.

MEGA SYNCHRO TAPPING HOLDER

TAPPING RANGE: No.0-No.6 (M1-M3)z



Catalog Number	Weight (lbs.)
HSK-A63-MGT3-100	2.2

- Nut is included, collet and wrench must be ordered separately
- When attaching or detaching the tap, a commercially available flat wrench (12mm width) is also required
- Not capable of supplying coolant through the holder body

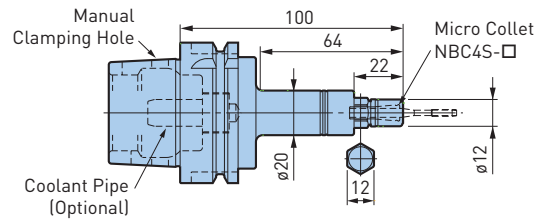
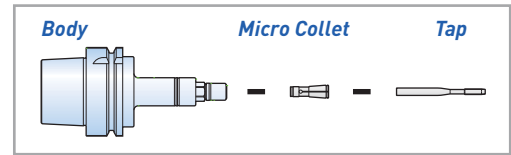

ACCESSORIES



CAUTION

Cannot be used with machining center without synchronized tapping function.

MEGA SYNCHRO TAPPING HOLDER

TAPPING RANGE: AU13/16-AU1-3/8 (M20-M36)

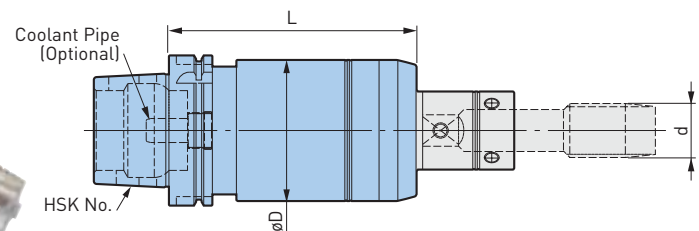
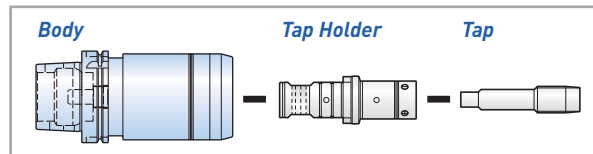

Catalog Number	Tapping Range d (Inch)	Tapping Range d (Metric)	øD	L	Weight (lbs.)
HSK-A100-MGT36-165	AU13/16-AU1-3/8 AP3/8-AP1	M20-M36	3.70	6.50	18.0
HSK-A125-MGT36-170	AU13/16-AU1-3/8 AP3/8-AP1	M20-M36	3.71	6.69	22.4

- MGT Set Screw and adjust screw are included, coolant pipe, tap holder must be ordered separately

ACCESSORIES



CAUTION

Cannot be used with machining center without synchronized tapping function.

CKB SHANK

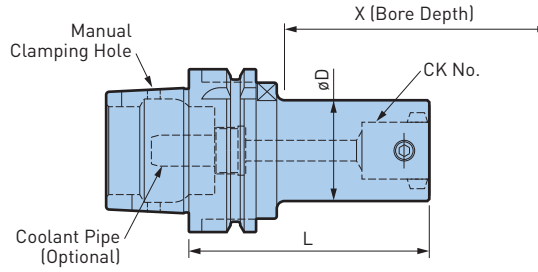
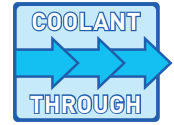

HSK A.3

Catalog Number	Reference Number	CK	øD	L	X	Weight (lbs.)
HSK-A25-CKB2-30	10.328.279F	CKB2	.945	1.181	1.968	.4
HSK-A32-CKB2-33	10.328.278F	CKB2	.945	1.299	1.693	.4
HSK-A40-CKB1-32	10.324.112F	CKB1	.748	1.240	1.575	.5
-CKB1-73	—			2.854	2.874	.8
-CKB2-35	10.328.277F	CKB2	.945	1.378	1.772	.5
-85	—			3.327	3.504	.9
-CKB3-40	10.324.132F	CKB3	1.220	1.575	2.165	.6
-80	—			3.150	3.346	1.1
-CKB4-50	10.324.142F	CKB4	1.535	1.968	2.835	.7
-73	—	CKB5	1.969	2.874	4.528	1.3
HSK-A50-CKB1-73	—	CKB1	.748	2.854	2.598	1.1
-CKB2-85	—	CKB2	.945	3.327	3.189	1.3
-CKB3-44	10.324.232F	CKB3	1.220	1.732	2.087	1.0
-80	—			3.150	3.268	1.5
-CKB4-48	10.324.242F	CKB4	1.535	1.890	2.520	1.1
-73	—			2.874	3.071	1.8
-CKB5-61	10.324.252F	CKB5	1.969	2.402	3.425	1.5
-83	—			3.268	5.315	2.2
HSK-A63-CKB1-79	10.324.312F	CKB1	.748	3.091	3.150	1.6
-CKB2-76	10.324.322F	CKB2	.945	3.760	3.937	1.8
-CKB3-71	10.324.331	CKB3	1.220	2.795	3.150	1.9
-100	—			3.937	4.055	2.4
-121	10.324.332			4.764	5.118	2.5
-CKB4-94	10.324.341	CKB4	1.535	3.701	4.331	2.5
-114	10.324.342			4.488	5.118	2.9
-CKB5-59	10.324.352	CKB5	1.969	2.323	3.504	2.1
-89	10.324.353			3.504	4.685	2.9
-CKB5-134	10.324.354			5.276	6.300	4.3
-CKB6-70	10.324.361	CKB6	2.500	2.756	4.331	2.8
-109	—			4.291	5.866	5.1
HSK-A80-CKB6-75	10.324.461	CKB6	2.500	2.953	4.528	4.3

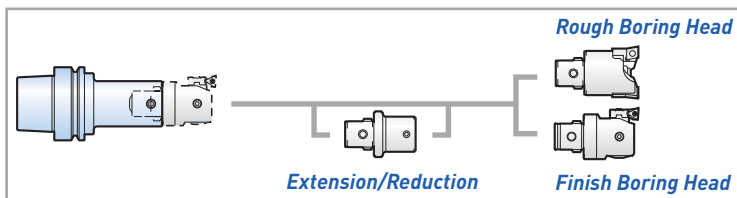

Catalog Number	Reference Number	CK	øD	L	X	Weight (lbs.)
HSK-A100-CKB1-103	—	CKB1	.748	4.035	3.661	5.5
-CKB2-115	—	CKB2	.945	4.508	4.252	5.7
-CKB3-124	10.324.531	CKB3	1.220	4.882	5.118	5.4
-CKB4-118	—	CKB4	1.535	4.646	4.843	6.6
-147	10.324.541			5.787	6.299	6.3
-CKB4-178	—			7.008	7.205	7.7
-CKB5-107	10.324.551	CKB5	1.969	4.213	5.118	6.4
-177	10.324.552			6.969	7.874	8.3
-CKB5-228	—			8.976	9.528	11.0
-CKB6-78	10.324.561	CKB6	2.500	3.071	4.528	6.4
-108	10.324.563			4.252	5.709	7.6
-169	—			6.654	7.756	11.7
-229	—			9.016	10.118	14.7
-CKB7-87	10.324.571	CKB7	3.543	3.425	6.850	8.9
-127	10.324.572			5.000	8.425	12.8
-213	—			8.386	10.669	22.4
-273	—			10.748	13.031	29.0
HSK-A125-CKB6-94	—	CKB6	2.520	3.701	4.803	11.4
-CKB7-123	—	CKB7	3.543	4.843	7.126	16.7

- X dimensions on the table are reference figures when EWN/EWE head is mounted
- Cutting edge and drive key grooves are located in the same orientation

CKN SHANK

Catalog Number	Reference Number	CK	øD	L	X	Weight (lbs.)
HSK-A63-CKN6-70	10.324.361N	CKN6	2.500	2.756	4.331	2.8
-160	10.324.367N		2.500	6.300	7.874	7.0
HSK-A100-CKN6-78	10.324.561N	CKN6	2.500	3.071	4.528	6.4
-108	10.324.563N		2.500	4.252	5.709	7.6
-223	10.324.566N		2.500	8.780	10.236	13.2
-CKN7-87	10.324.571N	CKN7	3.543	3.425	6.693	8.9
-127	10.324.572N		3.543	5.000	8.268	12.8
-267	10.324.575N		3.543	10.512	12.598	26.2

AG90 NBS TYPE

CLAMPING RANGE: ϕ .010"-.787"

MAX
6,000
RPM



HSK A.3

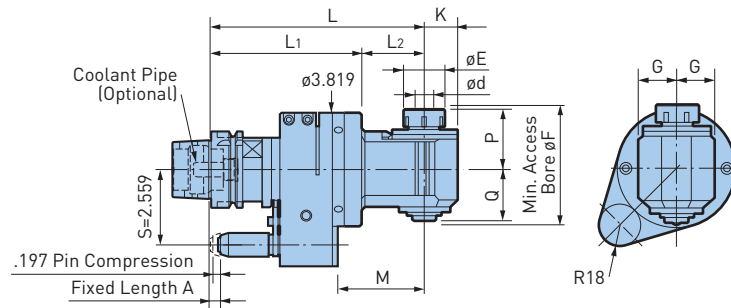

Catalog Number	ϕd	ϕE	G	K	L	L1	L2	M	P	Q	ϕF	Collet	Max RPM	Weight (lbs.)
HSK-A63-AG90/NBS6-185	.010-.236	.787	.827	.669	7.28	5.12	2.17	3.03	1.30	1.14	2.638	NBC6-□	6,000	13.0
-215					8.46		3.35	4.21						13.5
-245					9.65		4.53	5.39						13.9
-275					10.83		5.71	6.57						14.3
-AG90/NBS10-185	.059-.394	1.181	1.181	.984	7.28	5.12	2.17	3.03	1.77	1.69	3.583	NBC10-□	6,000	13.9
-215					8.46		3.35	4.21						14.8
-245					9.65		4.53	5.39						15.4
-AG90/NBS13-185	.098-.472	1.378	1.220	1.102	7.28	5.12	2.17	3.03	2.05	1.77	3.976	NBC13-□	6,000	14.1
-215					8.46		3.35	4.21						15.0
-245					9.65		4.53	5.39						15.7
-AG90/NBS20-200	.098-.787	1.811	1.378	1.378	7.87	5.12	2.76	3.62	2.56	2.44	5.197	NBC20-□	3,000	16.5
-AG90/NBS20S-180S				1.299	7.09		5.00							2.09

- Nut and wrench are included, coolant pipe and collet must be ordered separately
- The angles of the locating pin to the drive key groove and direction of cutting edge are freely adjustable
- A stop block is required when mounting on machines must be order separately
- When supplied through the stop block, coolant can be ejected from the housing
- Automatic tool change may not be available depending on machine tool models
- NEW BABY ENDMILL COLLETS cannot be used

ACCESSORIES



CAUTION

A Stop Block is required. The rotation of the cutting tool is in reverse direction of the machine spindle (Speed Ratio 1:1).

AG90 NBS TYPE

CLAMPING RANGE: ϕ .010"-.787"

MAX
6,000
RPM

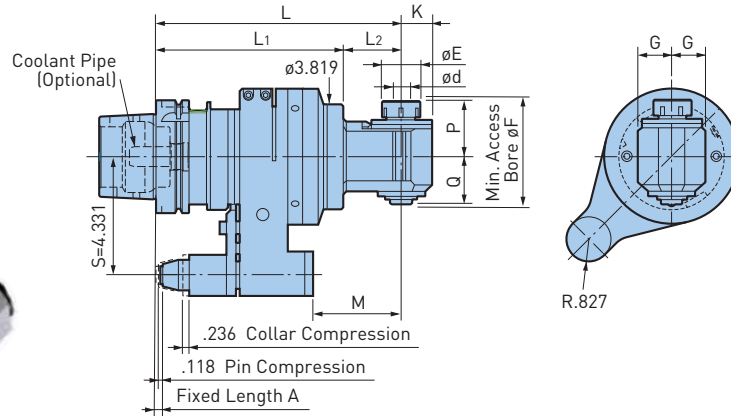

A.3
HSK

Catalog Number	ϕd	ϕE	G	K	L	L1	L2	M	P	Q	ϕF	Collet	Max RPM	Weight (lbs.)
HSK-A100-AG90/NBS6-225	.010-.236	.787	.827	.669	8.86	6.69	2.17	3.23	1.30	1.14	2.638	NBC6-□	6,000	26.0
-255					10.04		3.35	4.41						26.5
-285					11.22		4.53	5.59						27.3
-315					12.40		5.71	6.77						26.9
-AG90/NBS10-225	.059-.394	1.181	1.181	.984	8.86	6.69	2.17	3.23	1.77	1.69	3.583	NBC10-□	6,000	27.8
-255					10.04		3.35	4.41						28.4
-285					11.22		4.53	5.59						27.1
-AG90/NBS13-225	.098-.512	1.378	1.220	1.102	8.86	6.69	2.17	3.23	2.05	1.77	3.976	NBC13-□	6,000	28.0
-255					10.04		3.35	4.41						28.6
-285					11.22		4.53	5.59						29.5
-AG90/NBS20-240	.098-.787	1.811	1.378	1.378	9.45	6.69	2.76	3.82	2.44	2.44	5.197	NBC20-□	3,000	30.4

- Nut and wrench are included, coolant pipe and collet must be ordered separately
- The angles of the locating pin to the drive key groove and direction of cutting edge are freely adjustable
- A stop block is required when mounting on machines must be order separately
- When supplied through the stop block, coolant can be ejected from the housing
- Automatic tool change may not be available depending on machine tool models
- NEW BABY ENDMILL COLLETS cannot be used

ACCESSORIES



CAUTION

A Stop Block is required. The rotation of the cutting tool is in reverse direction of the machine spindle (Speed Ratio 1:1).

AG90 NBS EXTRA LONG TYPE

CLAMPING RANGE: \varnothing .010"-.787"

MAX
6,000
RPM

HSK A.3

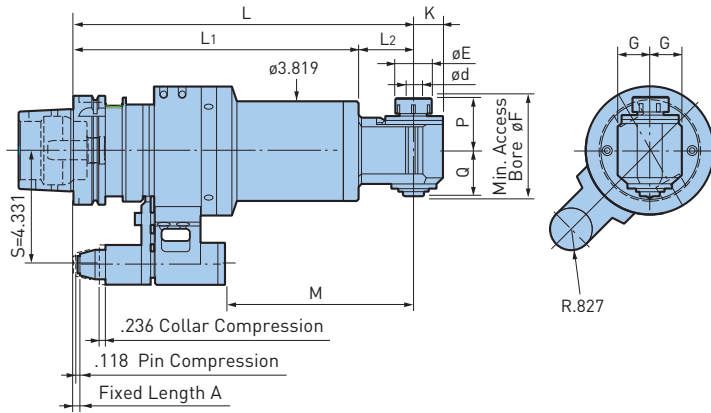

Catalog Number	$\varnothing d$	$\varnothing E$	G	K	L	L ₁	L ₂	M	P	Q	$\varnothing F$	Collet	Max RPM	Weight (lbs.)
HSK-A100-AG90/NBS6-325LS	.010-.236	.787	.827	.669	12.80	10.63	2.17	7.17	1.30	1.14	2.638	NBC6-□	6,000	39.9
-355LS					13.98		3.35	8.35						40.3
-385LS					15.16		4.53	9.53						40.8
-415LS					16.34		5.71	10.71						41.2
-425LS	.010-.236	.787	.827	.669	16.73	14.57	2.17	11.10	1.30	1.14	2.638	NBC6-□	6,000	49.6
-455LS					17.91		3.35	12.28						50.0
-485LS					19.09		4.53	13.46						50.5
-515LS					20.28		5.71	14.65						50.9
-525LS	.010-.236	.787	.827	.669	20.67	18.50	2.17	15.04	1.30	1.14	2.638	NBC6-□	6,000	59.3
-555LS					21.85		3.35	16.22						59.7
-585LS					23.03		4.53	17.40						60.2
-615LS					20.28		5.71	18.58						60.6

Catalog Number	ød	øE	G	K	L	L1	L2	M	P	Q	øF	Collet	Max RPM	Weight (lbs.)
HSK-A100-AG90/NBS10-325LS	.059-.394	1.181	1.181	.984	12.80	10.63	2.17	7.17	1.77	1.69	3.583	NBC10-□	6,000	40.8
-355LS					13.98		3.35	8.35						41.7
-385LS					15.16		4.53	9.53						42.3
-425LS	.059-.394	1.181	1.181	.984	16.73	14.57	2.17	11.10	1.77	1.69	3.583			50.5
-455LS					17.91		3.35	12.28						51.4
-485LS					19.09		4.53	13.46						52.0
-525LS	.059-.394	1.181	1.181	.984	20.67	18.50	2.17	15.04	1.77	1.69	3.583			60.2
-555LS					21.85		3.35	16.22						61.1
-585LS					23.03		4.53	17.40						61.7
-AG90/NBS13-325LS	.098-.512	1.378	1.220	1.102	12.80	10.63	2.17	7.17	2.05	1.77	3.976	NBC13-□	6,000	41.0
-355LS					13.98		3.35	8.35						41.9
-385LS					15.16		6.10	9.53						42.5
-425LS	.098-.512	1.378	1.220	1.102	16.73	14.57	2.17	11.10	2.05	1.77	3.976			50.7
-455LS					17.91		3.35	12.28						51.6
-485LS					19.09		6.10	13.46						52.2
-525LS	.098-.512	1.378	1.220	1.102	20.67	18.50	2.17	15.04	2.05	1.77	3.976			60.4
-555LS					21.85		3.35	16.22						61.3
-585LS					23.03		6.10	17.40						61.9
-AG90/NBS20-340LS	.098-.787	1.811	1.378	1.378	13.39	10.30	2.76	7.76	2.56	2.44	5.197	NBC20-□	3,000	43.4
-440LS	.098-.787	1.811	1.378	1.378	17.32	14.57	2.76	11.69	2.56	2.44	5.197			53.1
-540LS	.098-.787	1.811	1.378	1.378	21.26	18.50	2.76	15.63	2.56	2.44	5.197			62.8

- Nut and wrench are included, coolant pipe and collet must be ordered separately
- Output spindles of twin head do not rotate in forward direction simultaneously
- The angles of the locating pin to the drive key groove and direction of cutting edge are freely adjustable
- A stop block is required when mounting on machines must be order separately
- When supplied through the stop block, coolant can be ejected from the housing
- Automatic tool change may not be available depending on machine tool models
- NEW BABY ENDMILL COLLETS cannot be used

ACCESSORIES



CAUTION

A Stop Block is required. The rotation of the cutting tool is in reverse direction of the machine spindle (Speed Ratio 1:1).

AG90 COMPACT TYPE

CLAMPING RANGE: ϕ .098"-.512"

For Drilling Only — Ideal Size for Small Machining Centers

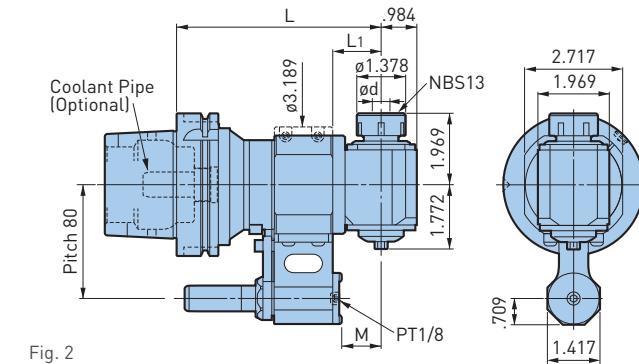
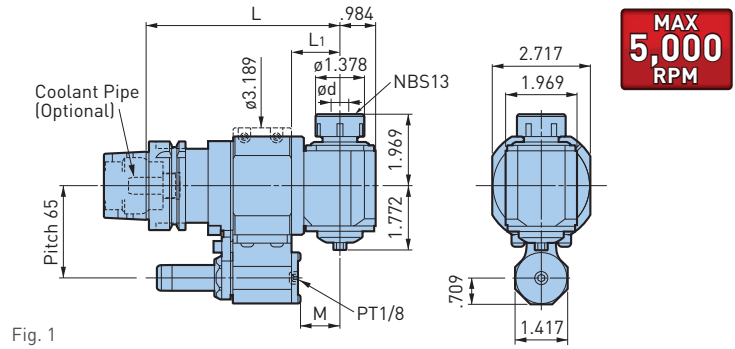

Catalog Number	Fig.	ϕ d	L	L1	M	Collet	Speed Ratio	Weight (lbs.)
HSK-A63-AG90-13-135	1	.098-.512	5.31	1.34	1.10	NBC13	1:1	4.4
-185			7.28	3.31	3.06			5.4
HSK-A100-AG90-13-145	2	.098-.512	5.71	1.34	1.10	NBC13	1:1	6.8
-195			7.68	3.31	3.06			7.8

- Nut and wrench are included, coolant pipe and collet must be ordered separately
- The angles of the locating pin to the drive key groove and direction of cutting edge are freely adjustable
- A stop block is required when mounting on machines must be order separately
- A tapped hole (PT1/8) is prepared at the bottom cover of the Locating Pin housing so that a pipe for coolant can be connected
- Automatic tool change may not be available depending on machine tool models
- NEW BABY ENDMILL COLLETS cannot be used

ACCESSORIES



CAUTION

A Stop Block is required. The rotation of the cutting tool is in reverse direction of the machine spindle (Speed Ratio 1:1). AG90 Compact Type is for drilling only.

APPLICATION EXAMPLE



Stable machining is obtained due to high rigidity and good runout.

DRILLING	
Cutter	ϕ .472" (12mm) Carbide Drill
Workpiece	1050 Steel
Cutting Speed	230 SFM
Cutting Feed	14.6 IPM
	.008 IPR
Spindle Speed	1,860 RPM

AG90 SLENDER DRIVE

CLAMPING RANGE: ϕ .098"-.512" For Angular Operations Within a ϕ 1.181 Inch Bore

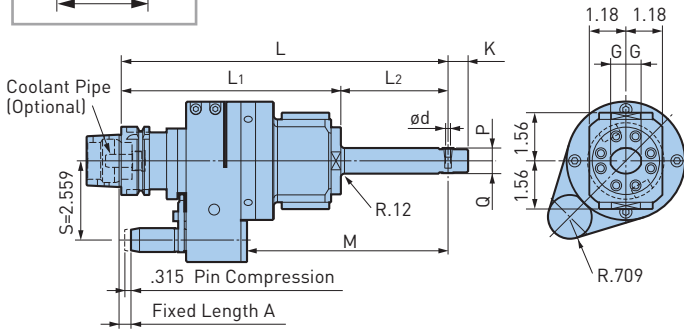
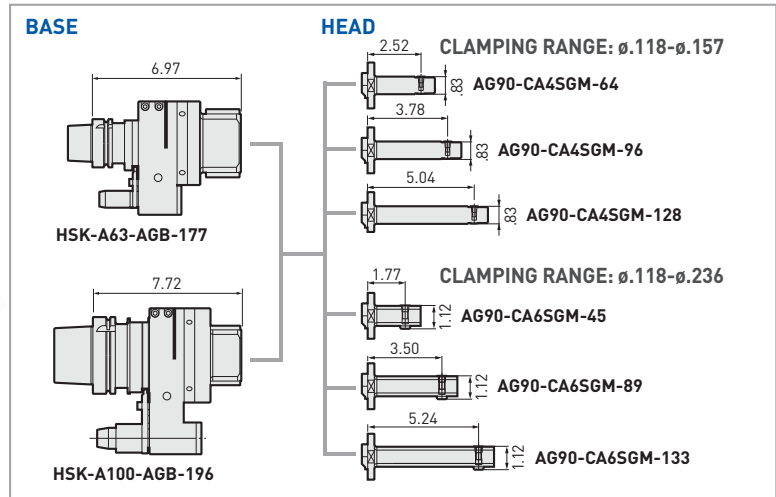

Fig. 1

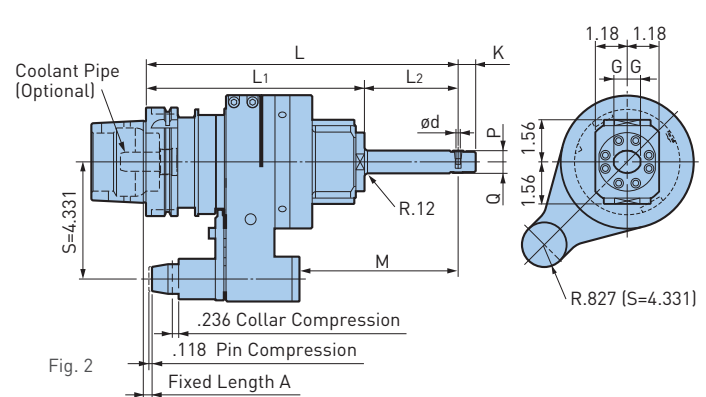

Fig. 2

Base	Head	Fig.	ϕd	G	K	L	L1	L2	M	P	Q	Speed Ratio	Weight (lbs.)
HSK-A63-AGB-177	AG90-CA4SGM-64	1	.118-.157	.492	.650	9.49	7.28	2.20	5.24	.41	.41	1:1.06 (Increase)	12.1
	-96					10.75		3.46	6.50				12.3
	-128					12.01		4.72	7.76				12.6
	AG90-CA6SGM-45	1	.118-.236	.591	.787	8.74	7.28	1.46	4.49	.49	.63	1:0.77 (Decrease)	12.3
	-89					10.47		3.19	6.22				12.8
	-133					12.20		4.92	7.95				13.2
HSK-A100-AGB-196	AG90-CA4SGM-64	2	.118-.157	.492	.650	10.24	8.03	2.20	4.61	.41	.41	1:1.06 (Increase)	24.5
	-96					11.50		3.46	5.87				24.7
	-128					12.76		4.72	7.13				24.9
	AG90-CA6SGM-45	2	.118-.236	.591	.787	9.49	8.03	1.46	3.86	.49	.63	1:0.77 (Decrease)	24.7
	-89					11.22		3.19	5.59				25.1
	-133					12.95		4.92	7.32				25.6

- Nut and wrench are included, coolant pipe and collet must be ordered separately
- The angles of the locating pin to the drive key groove and direction of cutting edge are freely adjustable
- A stop block is required when mounting on machines must be order separately
- Automatic tool change may not be available depending on machine tool models
- Coolant cannot be supplied through the locating pin

ACCESSORIES



CAUTION

A Stop Block is required. The rotation of the cutting tool is in same direction of the machine spindle.

AG90 BUILD-UP TYPE

For All Kinds of Machinery Applications

MAX
3,000
RPM

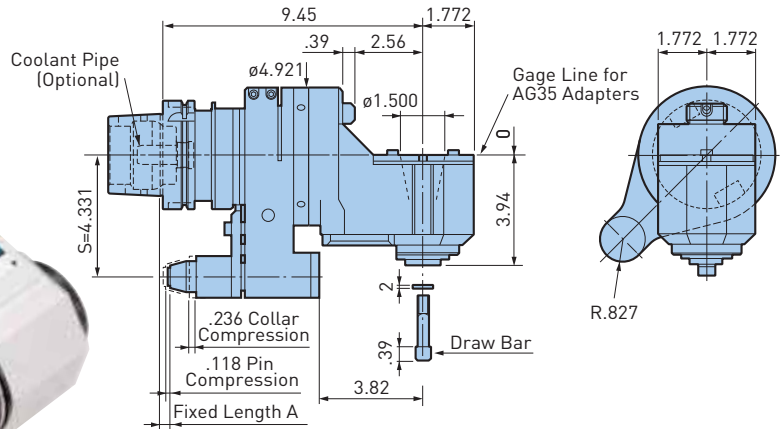

CAUTION

A Stop Block is required. The rotation of the cutting tool is in same direction of the machine spindle.

Catalog Number	Weight (lbs.)
HSK-A100-AG90/AGH35-240	31.2

- Wrench is included, coolant pipe must be ordered separately
- The angles of the locating pin to the drive key groove and direction of cutting edge are freely adjustable
- A stop block is required when mounting on machines must be order separately
- When supplied through the stop block, coolant can be ejected from the housing
- Automatic tool change may not be available depending on machine tool models

For Application Where Increased Rigidity is Required

MAX
3,000
RPM

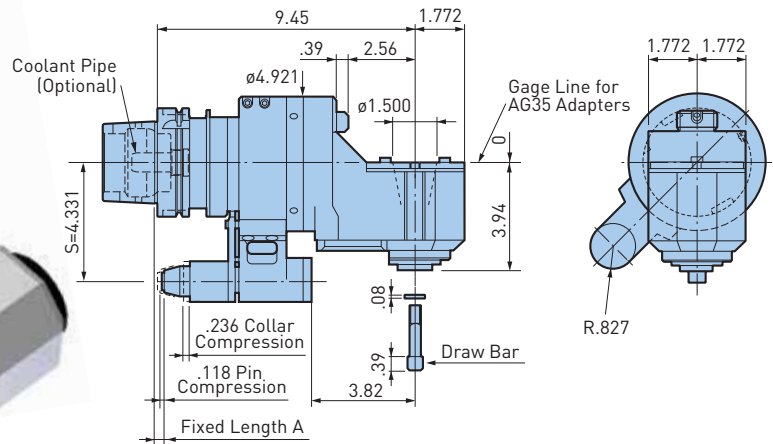

CAUTION

A Stop Block is required. The rotation of the cutting tool is in same direction of the machine spindle.

Catalog Number	Weight (lbs.)
HSK-A100-AG90/AGH35-240S	34.1

- Wrench is included, coolant pipe must be ordered separately
- The angles of the locating pin to the drive key groove and direction of cutting edge are freely adjustable
- A stop block is required when mounting on machines must be order separately
- When supplied through the stop block, coolant can be ejected from the housing
- Automatic tool change may not be available depending on machine tool models

ACCESSORIES



AG90 HMC TYPE

For Heavy Duty End Milling

MAX
3,000
RPM

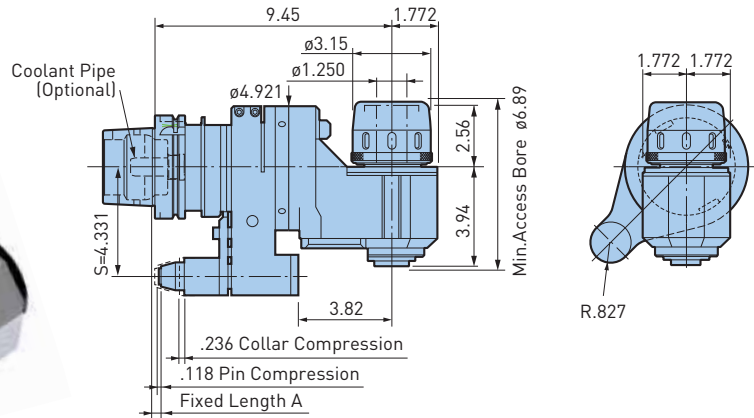

CAUTION

A Stop Block is required. The rotation of the cutting tool is in same direction of the machine spindle.

Catalog Number	Weight (lbs.)
HSK-A100-AG90/HMC1.250-240	35.2

- Wrench is included, coolant pipe must be ordered separately
- The angles of the locating pin to the drive key groove and direction of cutting edge are freely adjustable
- A stop block is required when mounting on machines must be order separately
- When supplied through the stop block, coolant can be ejected from the housing
- Automatic tool change may not be available depending on machine tool models

For Applications Where Increased Rigidity is Required

MAX
3,000
RPM

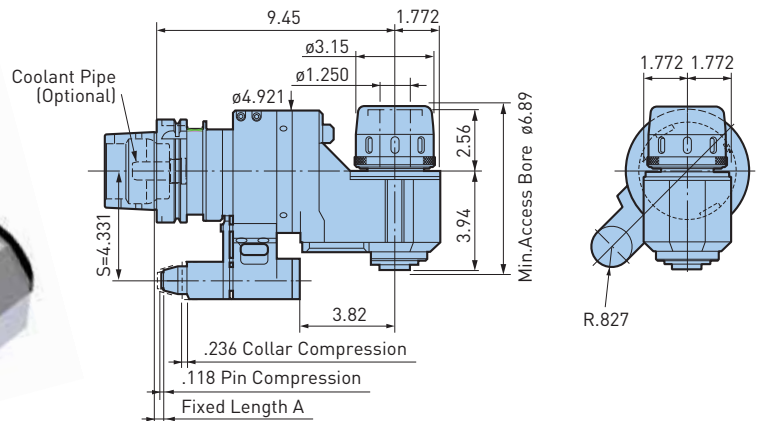

CAUTION

A Stop Block is required. The rotation of the cutting tool is in same direction of the machine spindle.

Catalog Number	Weight (lbs.)
HSK-A100-AG90/HMC1.250-240S	38.1

- Wrench is included, coolant pipe must be ordered separately
- The angles of the locating pin to the drive key groove and direction of cutting edge are freely adjustable
- A stop block is required when mounting on machines must be order separately
- When supplied through the stop block, coolant can be ejected from the housing
- Automatic tool change may not be available depending on machine tool models

ACCESSORIES



AGU UNIVERSAL TYPE

CLAMPING RANGE: ϕ .098"-.787" For Angular Operations

MAX
6,000
RPM

HSK A.3

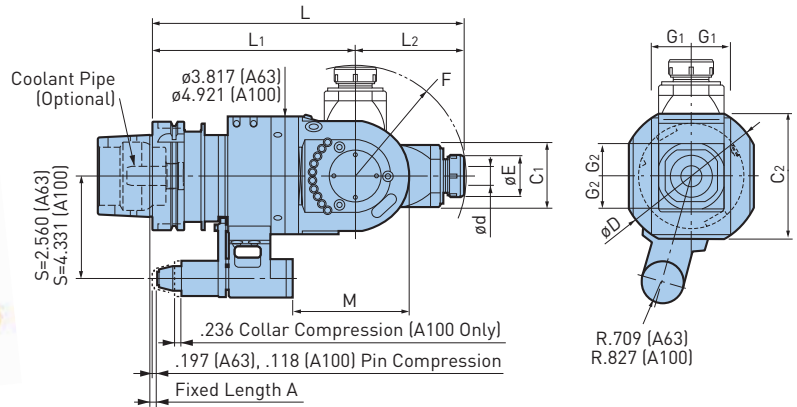

Catalog Number	ϕd	ϕE	ϕD	C1	C2	G1	G2	L	L1	L2	M	F	S	Collet	Max RPM	Weight (lbs.)
HSK-A63-AGU/NBS13-285	.098-.512	1.378	4.53	2.00	3.82	1.024	1.014	11.22	7.28	3.94	4.88	4.02	2.56	NBC13-□	6,000	21.2
HSK-A100-AGU/NBS20-325	.098-.787	1.811	5.51	2.56	4.92	1.299	1.280	12.80	8.27	4.53	4.92	4.65	4.33	NBC20-□	4,000	44.1

- Nut and wrench are included, coolant pipe and collet must be ordered separately
- The angles of the locating pin to the drive key groove and direction of cutting edge are freely adjustable
- A stop block is required when mounting on machines must be order separately
- Automatic tool change may not be available depending on machine tool models

ACCESSORIES



CAUTION

A Stop Block is required. The rotation of the cutting tool is in reverse direction of the machine spindle (Speed Ratio 1:1).



Exclusive Clamping Bolts and Nuts

Specially selected materials and special design for clamping the head guarantees rigidity even for end milling applications.



APPLICATION EXAMPLE

Adjustable AGU Universal Series expands ANGLE HEAD capabilities to accomplish various angular machining applications.

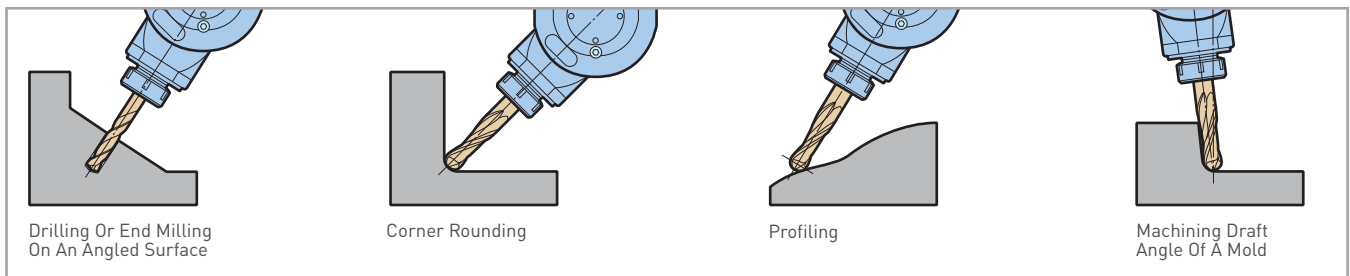

AGU30 TYPE

CLAMPING RANGE: ϕ .098"-.787" For Angular Operations



Angle Adjustment by Aligning Divisions

Spindle angle is easily adjustable from 0° to 30° using the scale indication on the body.

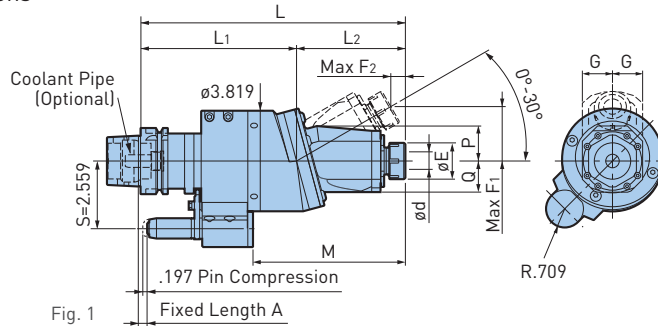
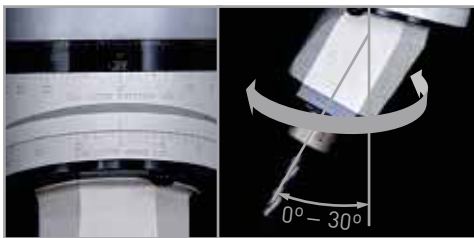

MAX
6,000
RPM

A.3
HSK

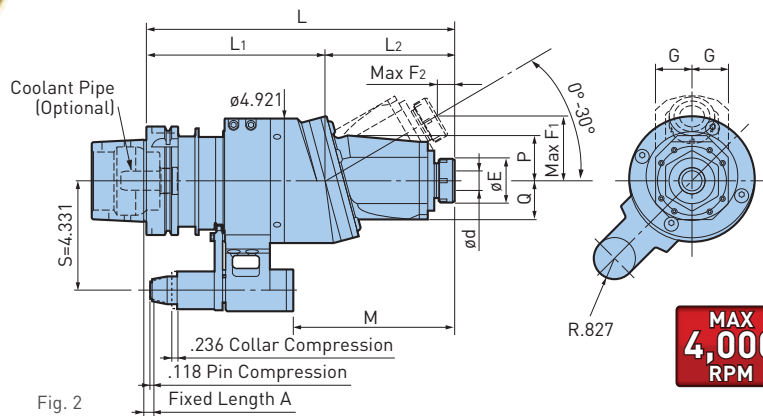

MAX
4,000
RPM

Catalog Number	Fig.	ϕ d	ϕ E	G	L	L1	L2	M	P	Q	F1	F2	Collet	Max RPM	Weight (lbs.)
HSK-A63-AGU30/NBS13-255	1	.098-.512	1.378	1.142	10.04	5.91	4.13	5.79	1.34	1.18	2.07	.55	NBC13-□	6,000	21.2
HSK-A100-AGU30/NBS20-305	2	.098-.787	1.811	1.437	12.01	6.89	5.12	6.38	1.77	1.54	2.56	.67	NBC20-□	4,000	44.1

- Nut and wrench are included, coolant pipe and collet must be ordered separately
- The angles of the locating pin to the drive key groove and direction of cutting edge are freely adjustable
- A stop block is required when mounting on machines must be order separately
- Automatic tool change may not be available depending on machine tool models
- When supplied through the stop block, coolant can be ejected from the housing

ACCESSORIES



CAUTION

A Stop Block is required. The rotation of the cutting tool is in reverse direction of the machine spindle (Speed Ratio 1:1).

SETTING DISC (INCLUDED)

For the precise adjustment of spindle angle or direction.

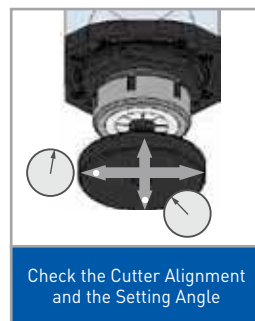

AIR POWER SPINDLE—RBX5 & RBX7 For High Speed Micro Machining with Automatic Tool Change

HSK A.3



**ZERO
MACHINE SPINDLE
ROTATION**

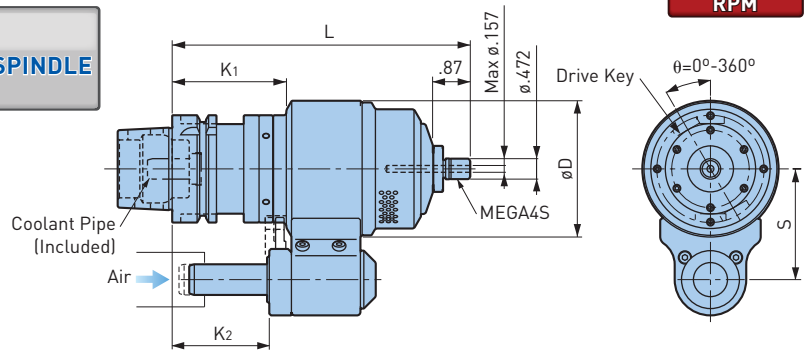

**MAX
80,000
RPM**

Catalog Number	Operating Spindle Speed (RPM)	Cutting Tool Diameter	L	øD	K1	K2	S	Weight (lbs.)
HSK-A63-RBX7-4S-175-65	60,000-80,000	ø.039 or smaller	6.89	3.150	2.64	2.24	2.559	8.4
-RBX5-4S-175-65	40,000-50,000	ø.059 or smaller		3.780				10.6
HSK-A100-RBX7-4S-180-80	60,000-80,000	ø.039 or smaller	7.09	3.937	2.83	2.44	3.150	18.5
-RBX5-4S-180-80	40,000-50,000	ø.059 or smaller						20.7

- Nut and wrench are included, collet must be ordered separately
- XF1-NPT (Air Unit) is required must be ordered separately

CAUTION ⚠

Compressed air to drive the AIR POWER SPINDLE must be clean. Coolant should not be supplied through the spindle on the machine that uses the AIR POWER SPINDLE.

For High Speed Micro Machining with Compressed Air Through the Machine Spindle

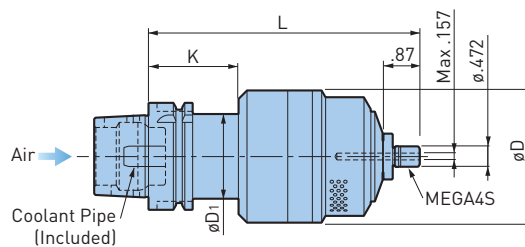

**MAX
80,000
RPM**

Catalog Number	Operating Spindle Speed (RPM)	Cutting Tool Diameter	L	øD	øD1	K	Weight (lbs.)
HSK-A63-RBX7C-4S-160	60,000-80,000	ø.039 or smaller	6.30	3.071	1.97	2.09	6.4
-RBX5C-4S-160	40,000-50,000	ø.059 or smaller		3.780			8.6
HSK-A100-RBX7C-4S-165	60,000-80,000	ø.039 or smaller	6.50	3.071	2.68	2.28	10.8
-RBX5C-4S-165	40,000-50,000	ø.059 or smaller		3.780			13.0

- Nut and wrench are included, collet must be ordered separately
- XF1-NPT (Air Unit) is required must be ordered separately

CAUTION ⚠

Compressed air to drive the AIR POWER SPINDLE must be clean. Coolant should not be supplied through the spindle on the machine that uses the AIR POWER SPINDLE.

ACCESSORIES



AIR POWER SPINDLE—RBX12 For High Speed Micro Machining with Small Cutter

**MAX
120,000
RPM**

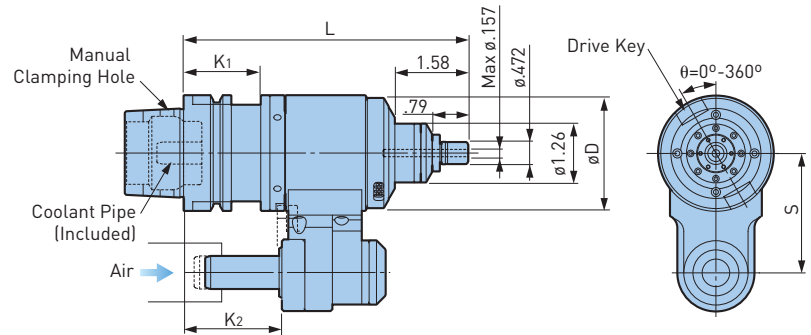

Catalog Number	Operating Spindle Speed (RPM)	Cutting Tool Diameter	L	øD	K1	K2	S	Nut	Collet	Weight (lbs.)
HSK-A63-RBX12-4S-155-65	100,000-120,000	ø.024 or smaller	6.10	2.480	—	2.09	2.559	MGN4S-HG	NBC4S-□	6.6

- Nut and wrench are included, collet must be ordered separately
- XF1-NPT (Air Unit) is required must be ordered separately

CAUTION

Compressed air to drive the AIR POWER SPINDLE must be clean. Coolant should not be supplied through the spindle on the machine that uses the AIR POWER SPINDLE.

A.3
HSK

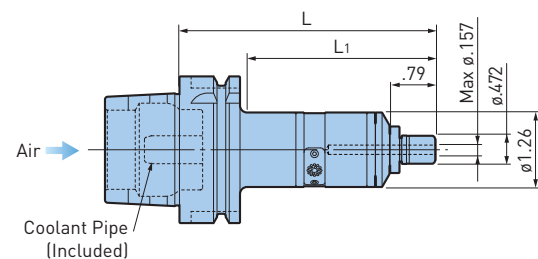

**MAX
120,000
RPM**

Catalog Number	Operating Spindle Speed (RPM)	L	L1	Nut	Collet	Weight (lbs.)
HSK-A63-RBX12C-4S-110	100,000-120,000	4.33	3.19	MGN4S-HG	NBC4S-□	2.2

- Nut and wrench are included, collet must be ordered separately
- XF1-NPT (Air Unit) is required must be ordered separately

CAUTION

Compressed air to drive the AIR POWER SPINDLE must be clean. Coolant should not be supplied through the spindle on the machine that uses the AIR POWER SPINDLE.

ACCESSORIES



APPLICATION EXAMPLE

PREHARDENED STEEL NAK55 SHOULDER CUTTING		
RBX12	Cutter	ø.6mm Carbide End Mill (ø.024")
	Spindle Speed	120,000 RPM ⇄ 116,000 RPM
	Feed	520 mm/min [20.5 IPM]
	D.O.C.	Ad .035" Rd .001"

PREHARDENED STEEL NAK55 GROOVING		
RBX12	Cutter	ø.6mm Carbide End Mill (ø.024")
	Spindle Speed	120,000 RPM ⇄ 116,000 RPM
	Feed	260 mm/min [10.2 IPM]
	D.O.C.	Ad .002"

MEGA MICRO CHUCK—TAPERED BODY

CLAMPING RANGE: ϕ .018"-.317" (ϕ .45-8.05mm)

For Micro Drill & End Mill Applications

HIGHER RIGIDITY

MAX 50,000 RPM

HSK A.3

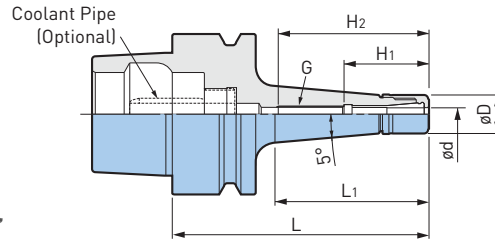

Catalog Number	ϕ d	ϕ D	L	L1	H1	H2	G	Collet	Nut	Wrench	Max RPM	Weight (lbs.)	
HSK-E25-MEGA3S-45T❖	.018-.128	.394	1.77	1.26	.87	[1.26]	—	NBC3S-□	MGN3S	MGR10	50,000	.1	
-60T			2.36	1.89		1.50	M4 P0.7				40,000	.2	
-MEGA4S-45T❖	.018-.159	.472	1.77	1.30	1.04	[1.26]	—	NBC4S-□	MGN4S	MGR12	50,000	.2	
-60T			2.36	1.93		1.61	M5 P0.8				40,000	.2	
-MEGA6S-45T❖	.018-.238	.551	1.77	1.30	1.12	[1.22]	—	NBC6S-□	MGN6S	MGR14	50,000	.2	
-60T			2.36	1.93		1.57	M7 P0.75				40,000	.2	
HSK-E32-MEGA3S-60T	.018-.128	.394	2.36	1.38	.87	1.50	M4 P0.7	NBC3S-□	MGN3S	MGR10	40,000	.3	
-75T			2.95	1.97							40,000	.4	
-MEGA4S-45T❖	.018-.159	.472	1.77	.91	1.04	[1.02]	—	NBC4S-□	MGN4S	MGR12	50,000	.3	
-60T			2.36	1.38		1.81	M5 P0.8				40,000	.4	
-MEGA6S-45T❖	.018-.238	.551	1.77	.91	1.12	[1.10]	—	NBC6S-□	MGN6S	MGR14	50,000	.3	
-60T			2.36	1.42		1.50	M7 P0.75				40,000	.4	
-MEGA8S-60T❖	.116-.317	.709	2.36	1.50	1.22	1.69	—	NBC8S-□	MGN8S	MGR18	30,000	1.9	
HSK-E40-MEGA3S-60T	.018-.128	.394	2.36	1.38	.87	1.54	M4 P0.7	NBC3S-□	MGN3S	MGR10	40,000	.5	
-75T			2.95	1.97		1.50					40,000	.6	
-MEGA4S-60T	.018-.159	.472	2.36	1.38	1.04	1.73	M5 P0.8	NBC4S-□	MGN4S	MGR12	40,000	.5	
-75T			2.95	1.97		1.85					40,000	.6	
-MEGA6S-60T❖	.018-.238	.551	2.36	1.38	1.12	[1.65]	—	NBC6S-□	MGN6S	MGR14	40,000	.5	
-75T			2.95	1.97		1.93	M7 P0.75					40,000	.6
-90T			3.54	2.56		40,000	.7						
HSK-E50-MEGA3S-80T	.018-.128	.394	3.15	1.93	.87	1.50	M4 P0.7	NBC3S-□	MGN3S	MGR10	40,000	1.0	
-MEGA4S-80T	.018-.159	.472	3.15	1.89	1.04	1.85	M5 P0.8	NBC4S-□	MGN4S	MGR12	40,000	1.0	
-MEGA6S-80T	.018-.238	.551	3.15	1.93	1.12	1.93	M7 P0.75	NBC6S-□	MGN6S	MGR14	40,000	1.1	

- MEGA MICRO NUT is included, coolant pipe, collet and wrench must be ordered separately
- Weight includes nut but does not include collet
- Please note that the practical spindle speed may be considerably influenced by the machine rigidity and tool balance, when using, slowly ramp up to the appropriate speed starting from slow speeds
- For models marked ❖, there is no internal thread, the dimension H2 in [] shows how deep a tool can be inserted
- In case our HSK tool holders are used in a machine which does not recommend the center through coolant, the plug screw should be mounted to our tools

ACCESSORIES



MEGA MICRO CHUCK

CLAMPING RANGE: $\varnothing.018$ "-.238" ($\varnothing.45$ -6.05mm)

For Micro Drill & End Mill Applications

MAX
50,000
RPM

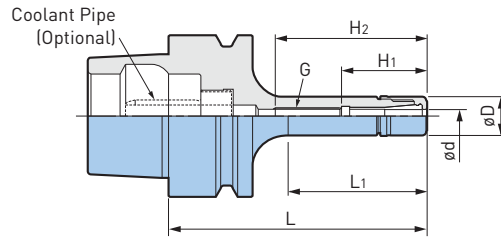

Catalog Number	$\varnothing d$	$\varnothing D$	L	L1	H1	H2	G	Collet	Nut	Wrench	Max RPM	Weight (lbs.)
HSK-E25-MEGA45-45❖ -60	.018-.159	.472	1.77	1.22	1.65	(1.26)	—	NBC4S-□	MGN4S	MGR12	50,000	.1
			2.36	1.81		1.85	—				40,000	.2
-MEGA6S-45❖ -60	.018-.238	.551	1.77	1.26	1.10	(1.22)	M7 P0.8	NBC6S-□	MGN6S	MGR14	50,000	.2
			2.36	1.85	1.12	1.61	M7 P0.75				40,000	.2
HSK-E32-MEGA3S-45❖ -60	.018-.159	.472	1.77	.87	1.04	1.22	M5 P0.8	NBC4S-□	MGN4S	MGR12	50,000	.3
			2.36	1.34		1.81					40,000	.3
-MEGA6S-45❖ -60	.018-.238	.551	1.77	.87	1.12	(1.10)	—	NBC6S-□	MGN6S	MGR14	50,000	.3
			2.36	1.38		1.50	M7 P0.75				40,000	.3
HSK-E40-MEGA3S-40❖ -60	.018-.159	.472	1.57	.75	1.04	(.94)	—	NBC3S-□	MGN3S	MGR10	50,000	.5
			2.36	1.34		1.73	M5 P0.8				40,000	.5
-MEGA6S-45❖ -60	.018-.238	.551	1.77	.91	1.12	(1.06)	—	NBC6S-□	MGN6S	MGR14	50,000	.5
			2.36	1.38		1.10	—				40,000	.5
HSK-E50-MEGA3S-50❖ -80	.018-.159	.472	1.97	.79	1.04	(1.18)	—	NBC3S-□	MGN3S	MGR10	45,000	.9
			3.15	1.73		1.85	M5 P0.8				40,000	1.0
-MEGA6S-55❖ -80	.018-.238	.551	2.17	1.02	1.12	(1.38)	—	NBC6S-□	MGN6S	MGR14	45,000	1.0
			3.15	1.73		1.93	M7 P0.75				40,000	1.0

- MEGA MICRO NUT is included, coolant pipe, collet and wrench must be ordered separately
- Weight includes nut but does not include collet
- Please note that the practical spindle speed may be considerably influenced by the machine rigidity and tool balance, when using, slowly ramp up to the appropriate speed starting from slow speeds
- For models marked ❖, there is no internal thread, the dimension H2 in () shows how deep a tool can be inserted
- In case our HSK tool holders are used in a machine which does not recommend the center through coolant, the plug screw should be mounted to our tools

ACCESSORIES



MEGA NEW BABY CHUCK

CLAMPING RANGE: ϕ .010"-.787" (ϕ .25-20mm)

For Drills, Reamers, Taps & Finishing End Mills

MAX
40,000
RPM

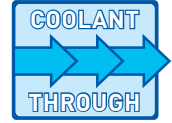

HSK A.3

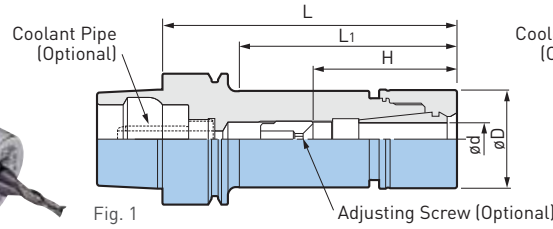

Fig. 1

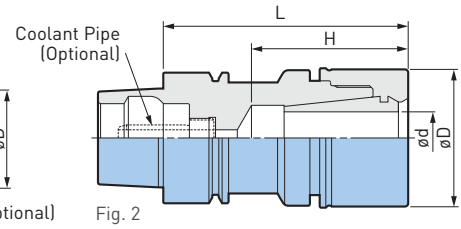

Fig. 2

Catalog Number	Fig.	ϕd	ϕD	L	L1	H	Collet	Nut	Wrench	Max RPM	Weight (lbs.)
HSK-E25-MEGA6N-40	1	.010-.236	.787	1.57	1.10	.98	NBC6-□	MGN6	MGR20	30,000	.2
-MEGA8N-45	2	.020-.315	.984	1.77	—	1.18	NBC8-□	MGN8	MGR25	25,000	.3
-MEGA10N-60		.059-.394	1.181	2.36	—	1.77	NBC10-□	MGN10	MGR30	20,000	.4
HSK-E32-MEGA6N-45	1	.010-.236	.787	1.77	.94	1.10	NBC6-□	MGN6	MGR20	40,000	.4
-60				2.36	1.42	.91-1.06				35,000	.4
-MEGA8N-50	1	.020-.315	.984	1.97	1.14	1.30	NBC8-□	MGN8	MGR25	40,000	.5
-65				2.56	1.69	1.02-1.26				35,000	.6
-MEGA10N-65	2	.059-.394	1.181	2.56	1.77	1.85	NBC10-□	MGN10	MGR30	30,000	.6
-MEGA13N-70	2	.098-.512	1.378	2.76	1.77	1.73	NBC13-□	MGN13	MGR35	25,000	.7
HSK-E40-MEGA6N-50	1	.010-.236	.787	1.97	1.02	1.22	NBC6-□	MGN6	MGR20	40,000	.6
-60				2.36	1.30	.91-1.02				35,000	.6
-75				2.95	1.89	.91-1.21				30,000	.7
-90				3.54	2.48	.91-1.69				28,000	.8
-120				4.72	3.66					25,000	.9
-MEGA8N-55	1	.020-.315	.984	2.17	1.22	1.42	NBC8-□	MGN8	MGR25	40,000	.7
-75				2.95	1.97	1.02-1.77				30,000	.8
-90				3.54	2.56					28,000	1.0
-MEGA10N-60	1	.059-.394	1.181	2.36	1.42	1.57	NBC10-□	MGN10	MGR30	35,000	.9
-75				2.95	2.01	2.17				30,000	1.0
-90				3.54	2.60	1.50-1.89				28,000	1.2
-MEGA13N-65	1	.098-.512	1.378	2.56	1.69	1.73	NBC13-□	MGN13	MGR35	30,000	1.0
-75				2.95	2.09	2.28				25,000	1.2
-90				3.54	2.68	1.73-1.89				20,000	1.4
-120				4.72	3.86	1.73-2.48				15,000	1.8
-150				5.91	5.04					15,000	2.2
-MEGA16N-65	2	.098-.630	1.654	2.56	—	1.81	NBC16-□	MGN16	MGR42	25,000	1.0
-75				2.95	—	1.89				20,000	1.3

Catalog Number	Fig.	ød	øD	L	L ₁	H	Collet	Nut	Wrench	Max RPM	Weight (lbs.)
HSK-E50-MEGA6N-55 ❖	1	.010-.236	.787	2.17	1.06	1.38	NBC6-□	MGN6	MGR20	40,000	1.0
-70				2.76	1.50	.91-1.54				30,000	1.1
-100				3.94	2.52	.91-1.69				25,000	1.2
-MEGA8N-60 ❖	1	.020-.315	.984	2.36	1.18	1.47	NBC8-□	MGN8	MGR25	40,000	1.2
-90				3.54	2.20	1.02-1.77□				30,000	1.4
-MEGA10N-60 ❖ ◆	1	.059-.394	1.181	2.36	1.18	1.38	NBC10-□	MGN10	MGR30	35,000	1.2
-90				3.54	2.28	1.50-1.89				30,000	1.5
-MEGA13N-70 ❖	1	.098-.512	1.378	2.76	1.57	1.77	NBC13-□	MGN13	MGR35	28,000	1.5
-90				3.54	2.36	1.73-1.85				25,000	1.8
-120				4.72	3.54	1.73-2.48				20,000	2.2
-150				5.91	4.72					15,000	2.7
-MEGA16N-75 ❖	1	.098-.630	1.654	2.95	1.89	2.05	NBC16-□	MGN16	MGR42L	28,000	1.9
-90 ❖				3.54	2.48	2.56				25,000	2.2
-MEGA20N-75 ❖ ◆	2	.098-.787	1.811	2.95	—	1.93	NBC20-□	MGN20	MGR46L	25,000	1.8
-100				3.94		2.01-2.13				20,000	2.4
-130				5.12		2.01-2.68				18,000	3.3

- MEGA NEW BABY NUT is included, coolant pipe, collet, wrench and adjusting screw must be ordered separately
- Weight includes nut but not collet
- Please note that the practical spindle speed may be considerably influenced by the machine rigidity and tool balance, when using, slowly ramp up to the appropriate speed starting from slow speeds
- "H" indicates the adjustment length with an adjusting screw
- "H" dimension is the Max tool shank length that can be inserted into the holder
- Adjusting screws cannot be used with models marked ❖
- NEW BABY E COLLET cannot be used with models marked ◆
- In case our HSK tool holders are used in a machine which does not recommend the center through coolant, the plug screw should be mounted to our tools

ACCESSORIES

 <p>COLLET PG. 338</p>	 <p>MEGA NUT PG. 344</p>	 <p>PERFECT SEAL PG. 346</p>	 <p>MEGA WRENCH PG. 368</p>	 <p>SCREW PG. 389</p>
---	---	---	--	--

ULTRA PRECISION SUPER SLIM

CLAMPING RANGE: $\varnothing 3\text{-}6\text{mm}$

Ultimate HYDRAULIC CHUCK with precision.
Runout accuracy of 1 micron at 4xD.

MAX
60,000
RPM

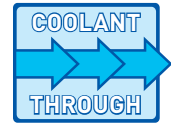

HSK A.3



ULTRA
PRECISION
1 μ m

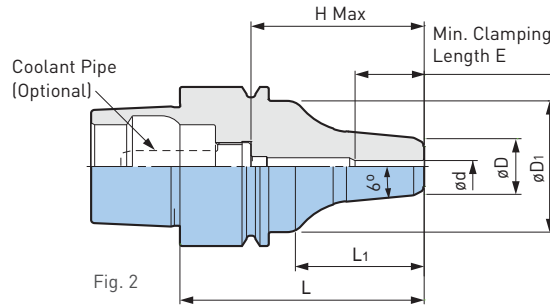
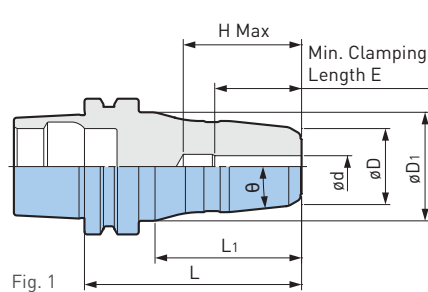

Catalog Number	Fig.	$\varnothing d$	$\varnothing D$	$\varnothing D1$	L	L1	θ	E	H Max	Max RPM	Weight (lbs.)
HSK-E25-HDC3S-40UP	1	3mm	.551	.79	1.58	1.06	6°	.63	.86	60,000	.2
-HDC3.175S-40UP		.125									
-HDC4S-40UP		4mm		.91				.83			
-HDC6S-45UP❖		6mm							1.02		
HSK-E32-HDC3S-52UP	1	3mm	.551	1.02	2.05	.59	6°	.63	1.10	45,000	.4
-HDC3.175S-52UP		.125									
-HDC4S-52UP		4mm		2.24				.98			
-HDC6S-57UP		6mm							1.30		
HSK-E40-HDC3S-55UP	2	3mm	.551	1.30	2.17	1.14	6°	.63	1.54	40,000	.7
-HDC3.175S-55UP		.125									
-HDC4S-55UP		4mm						2.36	.98		
-HDC6S-60UP		6mm									

- Coolant pipe must be ordered separately
- Adjusting screws cannot be used
- ❖ The body diameter of HSK-E25-HDC6S-45UP is 23mm (ISO standards=less than 20mm); some machines do not accept this large body diameter
- As for HSK-E40 holders, in case they are used in a machine which does not recommend the center through hole, the plug screw should be mounted to our tools

CAUTION

Use only cutting tools that have a shank tolerance of h6. Do not use with cutting tools made with a flat on the shank (ie: Weldon type shank). Roughing end mills are not recommended for use with Hydraulic Chucks. Do not tighten the clamping screw without first inserting a cutting tool into the tool holder. Always insert the cutting tool into the hydraulic tool holder beyond min. clamping length "E."

SUPER SLIM

CLAMPING RANGE: \varnothing 3-12mm Small design for micro machining.

MAX
60,000
RPM

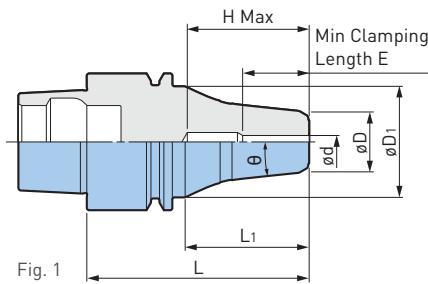
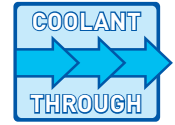

Fig. 1

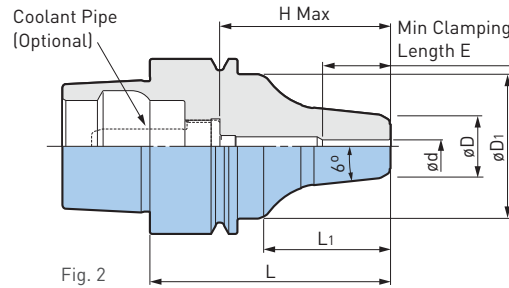

Fig. 2

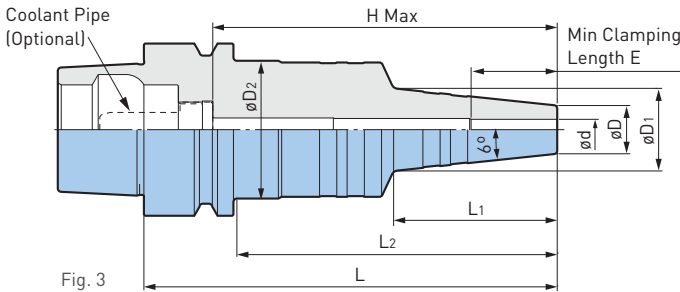

Fig. 3

CAUTION

Use only cutting tools that have a shank tolerance of h6. Do not use with cutting tools made with a flat on the shank (ie: Weldon type shank). Roughing end mills are not recommended for use with Hydraulic Chucks. Do not tighten the clamping screw without first inserting a cutting tool into the tool holder. Always insert the cutting tool into the hydraulic tool holder beyond min. clamping length "E."

Catalog Number	Fig.	$\varnothing d$	$\varnothing D$	$\varnothing D1$	$\varnothing D2$	L	L ₁	L ₂	θ	E	H Max	Max RPM	Weight (lbs.)					
HSK-E25-HDC3S-40	1	3mm	.551	.79	—	1.575	1.06	—	6°	.63	.86	60,000	.2					
-HDC3.175S-40		.125																
-HDC4S-40		4mm																
-HDC6S-45		6mm												.91	1.77	1.22	8°	.83
HSK-E32-HDC3S-52	1	3mm	.551	1.02	—	2.05	1.14	—	6°	.63	1.10	45,000	.4					
-HDC3.175S-52		.125																
-HDC4S-52		4mm																
-HDC6S-57		6mm												2.24	1.34	.98	1.30	
HSK-E40-HDC3S-55	2	3mm	.551	1.30	—	2.17	1.14	—	6°	.63	1.54	40,000	.7					
-HDC3.175S-55		.125																
-HDC4S-55		4mm																
-HDC6S-60		6mm												2.36	1.34	.98	1.57	
HSK-E50-HDC4S-120	3	4mm	.551	.94	1.57	4.72	1.85	3.66	6°	.75	3.94	30,000	2.0					
-HDC6S-120		6mm																
-HDC8S-120		8mm												.669	1.10	1.89	1.22	3.35
-HDC10S-120		10mm												.748	1.18	1.93	1.30	3.35
-HDC12S-120		12mm												.827	1.26	1.93	1.42	3.35

- HSK-E25/32 does not have coolant-through hole
- Coolant pipe must be ordered separately
- Adjusting screws cannot be used
- ❖ The body diameter of HSK-E25-HDC6S-45 is 23mm (ISO standards=less than 20mm); some machines do not accept this large body diameter
- For HSK-E40 holders, in case they are used in a machine which does not recommend the center through hole, the plug screw should be mounted to our tools

SHRINK FIT HOLDER—SLIM TYPE

CLAMPING RANGE: $\varnothing 4$ -12mm

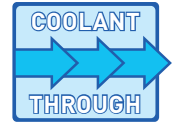
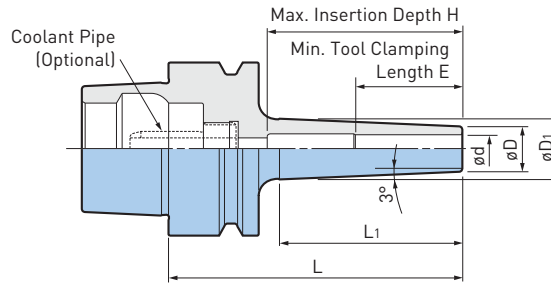

HSK A.3

Catalog Number	$\varnothing d$	$\varnothing D$	$\varnothing D_1$	L	L ₁	H	E	Weight (lbs.)
HSK-E25-SRC4S-45❖	.157	.276	.394	1.77	1.14	.71	.63	.1
-SRC6S-60	.236	.394	.591	2.36	1.81	1.81	1.02	.2
-SRC8S-60	.315	.512	.709		1.89			.2
HSK-E32-SRC4S-60❖	.157	.276	.394	2.36	1.30	1.69	1.02	.3
-SRC6S-60	.236	.394	.531		1.34			.3
-SRC8S-60	.315	.512	.650		1.42			.4
-SRC10S-60	.394	.630	.787		1.46			.4
-SRC12S-60	.472	.748	.906		1.46			.4
HSK-E40-SRC4S-60❖	.157	.276	.394	2.36	1.34	1.73	.63	.5
-SRC6S-75	.236	.394	.591	2.95	1.93	2.05	1.02	.5
-SRC8S-75	.315	.512	.709					.5
-SRC10S-75	.394	.630	.827			2.20	1.26	.6
-SRC12S-75	.472	.748	.945				1.42	.7

- Coolant pipe must be ordered separately
- Use a carbide shank cutter within a tolerance of h6
- Center through coolant supply is available with tools with oil holes
- Always insert the cutting tool into the holder beyond the min. clamping length E
- Use a carbide shank with a tolerance within h5 with models marked ❖

CAUTION ⚠

Some shrink fit machines may not be compatible with the Shrink Chuck. Please refer to the shrink fit machine operation manual.

CKB SHANK

Symmetrical Execution for High Speed Machine Spindles

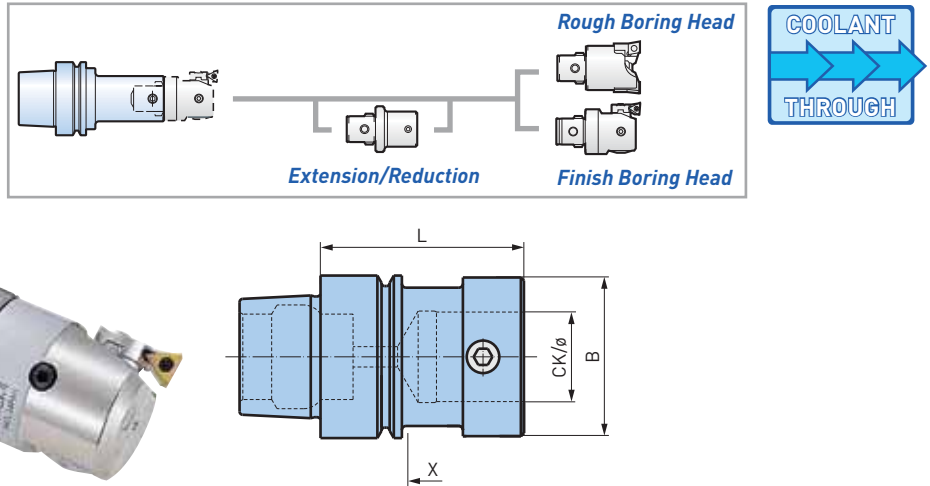

Catalog Number	Refence Number	CK	øD	L	X	Weight (lbs.)
HSK-E25-CKB1-22	10.328.249F	CKB1	.748	.866	1.575	.1
-CKB2-30	10.328.281F	CKB2	.945	1.181	1.969	.2
HSK-E32-CKB1-40	10.328.257F	CKB1	.748	1.575	1.969	.3
-CKB2-33	10.328.280F	CKB2	.945	1.299	1.693	.3
-CKB3-48	10.328.151F	CKB3	1.220	1.890	2.677	.4
-CKB4-68	10.328.218F	CKB4	1.535	2.677	3.543	.4
HSK-E40-CKB1-32	10.324.111F	CKB1	.748	1.240	1.575	.5
-CKB2-35	10.324.121F	CKB2	.945	1.378	1.772	.5
-CKB3-40	10.324.131F	CKB3	1.220	1.575	2.165	.6
-CKB4-50	10.324.141F	CKB4	1.535	1.969	2.835	.8
HSK-E50-CKB3-44	10.324.231F	CKB3	1.220	1.732	2.087	1.0
-CKB4-48	10.324.241F	CKB4	1.535	1.890	2.520	1.1
-CKB5-61	10.324.251F	CKB5	1.968	2.402	3.425	1.6

- Coolant pipe must be ordered separately
- X dimensions on the table are reference figures when EWN/EWE head is mounted
- All shanks are precision balanced

AIR POWER SPINDLE—RBX12

ZERO
MACHINE SPINDLE
ROTATION

MAX
120,000
RPM

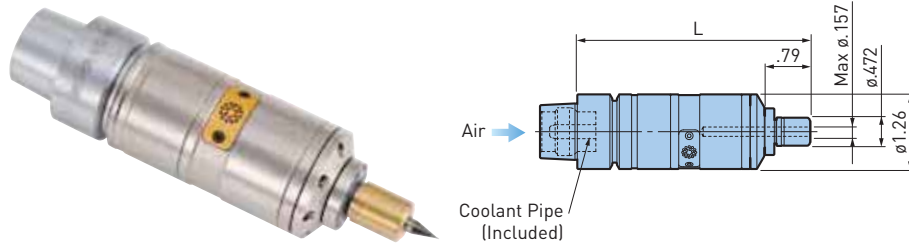

Catalog Number	Operating Spindle Speed (RPM)	L	Nut	Collet	Weight (lbs.)
HSK-E32-RBX12C-4S-100	100,000-120,000	3.94	MGN4S-HG	NBC4S-□	1.0

- Nut and wrench are included, collet must be ordered separately
- XF1-NPT (Air Unit) is required must be ordered separately

CAUTION ⚠

Compressed air to drive the AIR POWER SPINDLE must be clean. Coolant should not be supplied through the spindle on the machine that uses the AIR POWER SPINDLE.

ACCESSORIES



APPLICATION EXAMPLE

PREHARDENED STEEL NAK55 SHOULDER CUTTING		
RBX12	Cutter	ø.6mm Carbide End Mill (ø.024")
	Spindle Speed	120,000 RPM ⇄ 116,000 RPM
	Feed	520 mm/min [20.5 IPM]
	D.O.C.	Ad .035" Rd .001"

PREHARDENED STEEL NAK55 GROOVING		
RBX12	Cutter	ø.6mm Carbide End Mill (ø.024")
	Spindle Speed	120,000 RPM ⇄ 116,000 RPM
	Feed	260 mm/min [10.2 IPM]
	D.O.C.	Ad .002"

AIR POWER SPINDLE—RBX12 MANUAL TOOL CHANGE TYPE

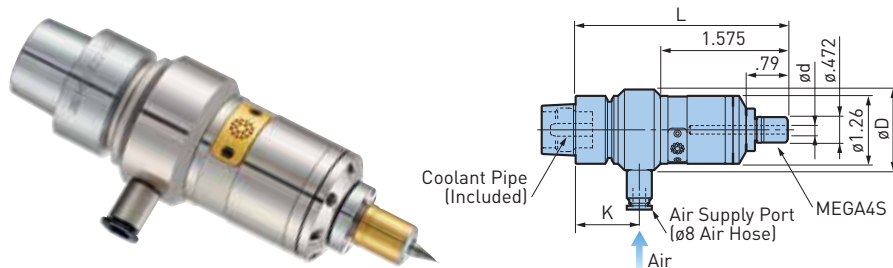

Catalog Number	Operating Spindle Speed (RPM)	ød	Usable Tool Dia.	øD	L	K	Nut	Collet	Weight (lbs.)
HSK-E32-RBX12-4S-100H	100,000-120,000	.45-4.05	ø.6 or smaller	1.50	3.94	1.18	MGN4S-HG	NBC4S-□	1.1

- Nut and wrench are included, collet must be ordered separately
- XF1-NPT (Air Unit) is required must be ordered separately

CAUTION ⚠

Compressed air to drive the AIR POWER SPINDLE must be clean. Coolant should not be supplied through the spindle on the machine that uses the AIR POWER SPINDLE.

ACCESSORIES



MEGA MICRO CHUCK

CLAMPING RANGE: $\varnothing.018$ " - $.238$ " ($\varnothing.45$ - 6.05 mm)

For Micro Drill & End Mill Applications

MAX
32,000
RPM

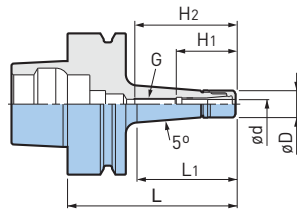

Fig. 1 (High Rigidity Type)

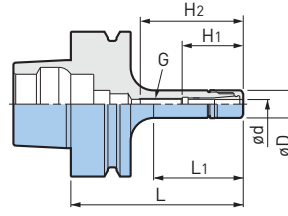

Fig. 2 (Straight Type)

Catalog Number	Fig.	$\varnothing d$	$\varnothing D$	L	L1	H1	H2	G	Collet	Nut	Wrench	Max RPM	Weight (lbs.)
HSK-F63-MEGA4S-75T	1	.018-.159	.472	2.95	1.73	1.04	1.61	M5 P0.8	NBC4S-□	MGN4S	MGR12	32,000	1.5
-MEGA6S-75T		.018-.238	.551	2.95	1.73	1.12	1.61	M7 P0.75	NBC6S-□	MGN6S	MGR14		1.5
-MEGA8S-75T		.116-.317	.709			1.22	2.28	M9 P0.75	NBC8S-□	MGN8S	MGR25		1.5
-MEGA4S-75	2	.018-.159	.472	2.95	1.54	1.04	1.61	M5 P0.8	NBC4S-□	MGN4S	MGR12	30,000	1.5
-105				4.13	2.99		1.85					25,000	1.5
-MEGA6S-75		.018-.238	.551	2.95	1.81	1.12	1.61	M7 P0.75	NBC6S-□	MGN6S	MGR14	30,000	1.5
-90				3.54	2.40		1.93					27,000	1.6
-105				4.13	2.99							25,000	1.7

- MEGA MICRO NUT is included, coolant pipe, collet and wrench must be ordered separately
- Please note that the practical spindle speed may be considerably influenced by the machine rigidity and tool balance, when using, slowly ramp up to the appropriate speed starting from slow speeds
- Contact us for a plug screw to block a coolant through hole
- In case our HSK tool holders are used in a machine which does not recommend the center through coolant, the plug screw should be mounted to our tools

ACCESSORIES



A.3
HSK

MEGA NEW BABY CHUCK

CLAMPING RANGE: $\varnothing.010$ "-.787" ($\varnothing.25$ -20mm)

For Drills, Reamers, Taps & Finishing End Mills

MAX
35,000
RPM

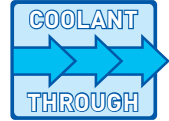

HSK A.3

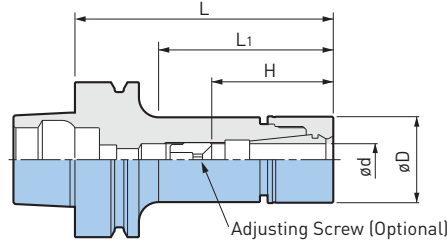

Catalog Number	$\varnothing d$	$\varnothing D$	L	L ₁	H	Collet	Nut	Wrench	Max RPM	Weight (lbs.)
HSK-F63-MEGA6N-75	.010-.236	.787	2.95	1.65	.91-1.22	NBC6-□	MGN6	MGR20	35,000	1.5
-90			3.54	2.09	.91-1.69				30,000	1.8
-105			4.13	2.72					25,000	1.8
-135			5.31	3.90					20,000	2.0
-MEGA8N-75	.020-.315	.984	2.95	1.69	1.02-1.50	NBC8-□	MGN8	MGR25	32,000	1.8
-90			3.54	2.13	1.02-1.77				30,000	2.0
-105			4.13	2.72					25,000	2.0
-120			4.72	3.31					20,000	2.2
-135			5.31	3.90					15,000	2.4
-165			6.50	5.08						
-MEGA10N-75❖	.059-.354	1.181	2.95	1.69	1.89	NBC10-□	MGN10	MGR30	32,000	2.0
-90			3.54	2.13	1.50-1.89				30,000	2.0
-105			4.13	2.72					25,000	2.2
-120			4.72	3.31					20,000	2.4
-MEGA13N-75❖	.098-.512	1.378	2.95	1.69	1.85	NBC13-□	MGN13	MGR35	30,000	2.0
-90❖			3.54	2.20	2.40				25,000	2.4
-105			4.13	2.80	1.73-2.09				20,000	2.6
-120			4.72	3.39	1.73-2.48				15,000	3.5
-165			6.50	5.16						
-MEGA16N-75❖	.098-.630	1.654	2.95	1.69	1.89	NBC16-□	MGN16	MGR42	30,000	2.2
-90❖			3.54	2.28	2.40				25,000	2.6
-105			4.13	2.87	1.89-2.20				20,000	2.9
-MEGA20N-75❖	.098-.787	1.811	2.95	1.77	2.01	NBC20-□	MGN20	MGR46	30,000	2.4
-90❖			3.54	2.36	2.40				25,000	2.9
-105			4.13	2.95	2.01-2.28				20,000	3.1

- MEGA NEW BABY NUT is included, coolant pipe, collet, wrench and adjusting screw must be ordered separately
- Please note that the practical spindle speed may be considerably influenced by the machine rigidity and tool balance, when using, slowly ramp up to the appropriate speed starting from slow speeds
- "H" indicates the adjustment length with an adjusting screw
- "H" dimension is the Max tool shank length that can be inserted into the holder
- Contact us for a plug screw to block a coolant through hole
- Adjusting screws cannot be used with models marked ❖
- In case our HSK tool holders are used in a machine which does not recommend the center through coolant, the plug screw should be mounted to our tools

ACCESSORIES



MEGA E CHUCK

CLAMPING RANGE: \varnothing .125"-.50" (\varnothing 3-12mm)

Exclusively for High Speed Finish End Milling

MAX
30,000
RPM

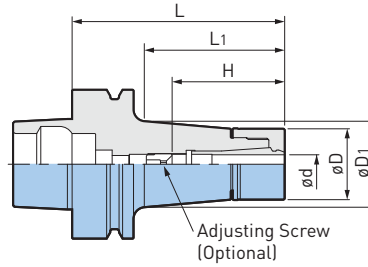
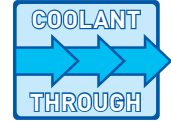

A.3
HSK

Catalog Number	$\varnothing d$	$\varnothing D$	$\varnothing D_1$	L	L ₁	H	Collet	Nut	Wrench	Max RPM	Weight (lbs.)
HSK-F63-MEGA6E-65 ❖ -90	.125-.250 (3-6mm)	.984	1.11	2.56	1.34	1.54	MEC6-□	MEN6	MGR25	30,000	1.8
			1.23	3.54	2.28	1.46-1.77					2.0
-MEGA8E-65 ❖ -90	.125-.250 (3-8mm)	1.181	1.29	2.56	1.34	1.61	MEC8-□	MEN8	MGR30	30,000	1.8
			1.43	3.54	2.32	1.65-1.85					2.2
-MEGA10E-75 ❖ -90 ❖ -105 -120 -135	.125-.375 (3-10mm)	1.378	1.51	2.95	1.73	1.89	MEC10-□	MEN10	MGR35	30,000	2.2
			1.62	3.54	2.32	2.64					2.6
			1.73	4.13	2.95	1.89-2.28					2.9
			1.84	4.72	3.58						3.5
			1.93	5.31	4.21						4.0
-MEGA13E-75 ❖ -90 ❖ -105 -135	.125-.500 (3-12mm)	1.654	1.80	2.95	1.85	1.97	MEC13-□	MEN13	MGR42	30,000	2.4
			1.90	3.54	2.44	2.52					3.1
			2.01	4.13	3.07	1.97-2.28					3.5
			2.04	5.31	4.25	1.97-2.36					4.4

- MEGA E NUT is included, coolant pipe, collet, wrench and adjusting screw must be ordered separately
- Please note that the practical spindle speed may be considerably influenced by the machine rigidity and tool balance, when using, slowly ramp up to the appropriate speed starting from slow speeds
- "H" indicates the adjustment length with an adjusting screw
- "H" dimension is the Max tool shank length that can be inserted into the holder
- Contact us for a plug screw to block a coolant through hole
- Adjusting screws cannot be used with models marked ❖
- In case our HSK tool holders are used in a machine which does not recommend the center through coolant, the plug screw should be mounted to our tools

ACCESSORIES



MEGA DOUBLE POWER CHUCK

CLAMPING RANGE: \varnothing 16-32mm

For Heavy Duty End Milling

**MAX
28,000
RPM**

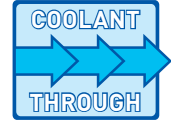

HSK A.3

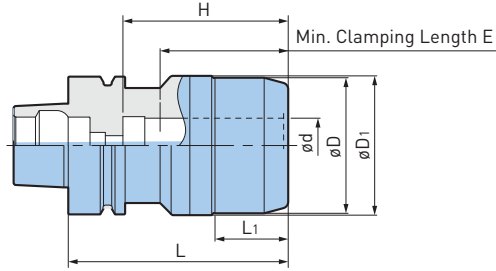

Catalog Number	$\varnothing d$	$\varnothing D$	$\varnothing D1$	L	L1	H	E	Wrench	Weight (lbs.)
HSK-F63-MEGA16D-80A	16mm	1.654	2.087	3.15	.98	2.17	1.97	MGR42L	2.6
-MEGA20D-90A	20mm	1.969	2.165	3.54	1.34	2.56	2.20	MGR50L	3.1
-MEGA25D-100A	25mm	2.441	2.480	3.94	1.54	2.95	2.24	MGR62L	4.0
-MEGA32D-105A	32mm	2.756	2.795	4.13	1.30	3.15	2.52	MGR70L	4.4

- Wrench must be ordered separately
- Please note that the practical spindle speed may be considerably influenced by the machine rigidity and tool balance, when using, slowly ramp up to the appropriate speed starting from slow speeds
- "H" dimension is the Max tool shank length that can be inserted into the holder
- Contact us for a plug screw to block a coolant through hole
- In case our HSK tool holders are used in a machine which does not recommend the center through coolant, the plug screw should be mounted to our tools

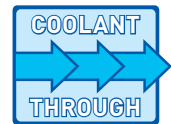
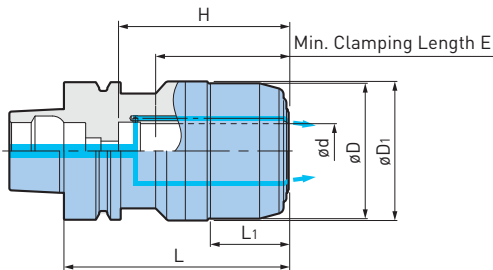

Catalog Number	$\varnothing d$	$\varnothing D$	$\varnothing D1$	L	L1	H	E	Wrench	Weight (lbs.)
HSK-F63-MEGA16DS-80A	16mm	1.654	2.087	3.23	1.06	2.24	2.05	MGR42L	2.6
-MEGA20DS-90A	20mm	1.969	2.165	3.62	1.42	2.64	2.28	MGR50L	3.1
-MEGA25DS-100A	25mm	2.441	2.480	4.02	1.61	3.03	2.32	MGR62L	4.0
-MEGA32DS-105A	32mm	2.756	2.795	4.21	1.38	3.23	2.60	MGR70L	4.4

- Wrench must be ordered separately
- Please note that the practical spindle speed may be considerably influenced by the machine rigidity and tool balance, when using, slowly ramp up to the appropriate speed starting from slow speeds
- Jet-through type provides coolant form the chuck nose, thus tools with oil holes cannot be used
- "H" dimension is the Max tool shank length that can be inserted into the holder
- Contact us for a plug screw to block a coolant through hole
- In case our HSK tool holders are used in a machine which does not recommend the center through coolant, the plug screw should be mounted to our tools

ACCESSORIES



SUPER SLIM TYPE

CLAMPING RANGE: \varnothing 3mm-12mm

For Drills, Reamers, Ball Mills, End Mills, Diamond Reamers & Grinding Tools

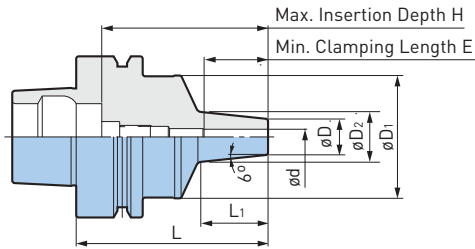
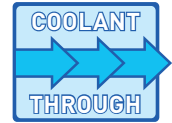

Catalog Number	$\varnothing d$	$\varnothing D$	$\varnothing D_1$	$\varnothing D_2$	L	L1	H	E	Max RPM	Weight (lbs.)
HSK-F63-HDC3S-75	3mm	.551	1.890	.787	2.95	1.02	2.56	.63	30,000	2.2
-HDC4S-75	4mm							.75	30,000	2.2
-HDC6S-75	6mm							.98	30,000	2.2
-HDC8S-75	8mm							1.22	30,000	2.2
-HDC10S-75	10mm							1.30	30,000	2.2
-HDC12S-75	12mm							1.42	30,000	2.2

- Adjusting screws cannot be used
- In case our HSK tool holders are used in a machine which does not recommend the center through coolant, the plug screw should be mounted to our tools

CAUTION

Use only cutting tools that have a shank tolerance of h6. Do not use with cutting tools made with a flat on the shank (ie: Weldon type shank). Roughing end mills are not recommended for use with HYDRAULIC CHUCKS. Do not tighten the clamping screw without first inserting a cutting tool into the tool holder. Always insert the cutting tool into the hydraulic tool holder beyond min. clamping length "E".

A.3 HSK

FACE MILL ARBOR—TYPE A

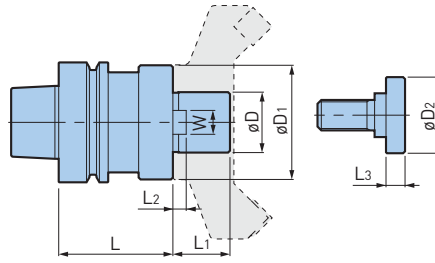
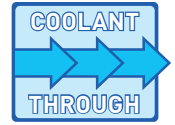

HSK A.3

Catalog Number	øD	øD1	øD2	L	L1	L2	L3	W	Clamping Screw	Weight (lbs.)
HSK-F63-FMA25.4-45	25.4mm	1.77	1.30	1.77	.866	.197	.39	.375	MBA-M12	2.2

- Clamping screw is included

CKB SHANK

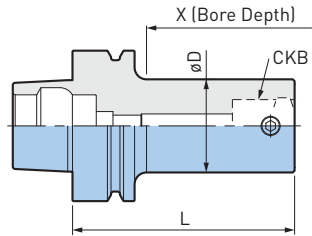
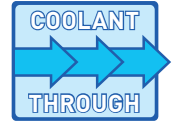

Catalog Number	CK	øD	L	X	Weight (lbs.)
HSK-F63-CKB1-78	CKB1	.748	3.051	2.874	1.8
-CKB2-90	CKB2	.945	3.524	3.701	1.8
-CKB3-100	CKB3	1.220	3.937	4.252	2.2
-CKB4-93	CKB4	1.535	3.661	4.252	2.6
-CKB5-83	CKB5	1.968	3.268	4.488	2.9

• X dimensions on the table are reference figures when EWN/EWE head is mounted

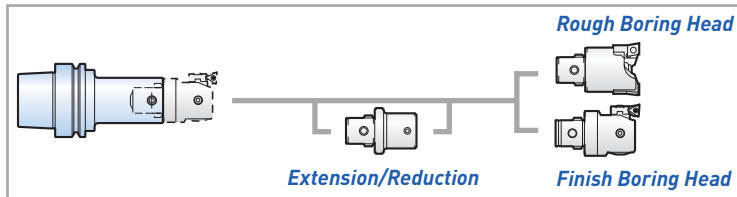

MONO BLOCK TYPE—FORM A/E

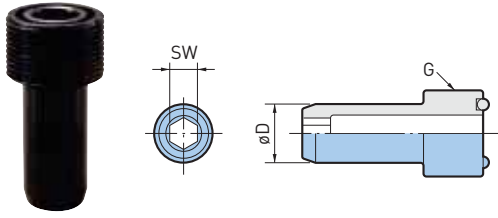

Catalog Number	øD	G	SW (mm)	
HSK25-CP	5mm	M8 P1	2.5mm	
HSK32-CP	6mm	M10 P1	3mm	
HSK40-CP	8mm	M12 P1	4mm	
HSK50-CP	10mm	M16 P1	5mm	
HSK63-CP	12mm	M18 P1	6mm	
HSK80-CP	14mm	M20 P1.5	8mm	
HSK100-CP	16mm	M24 P1.5	8mm	
HSK125-CP	18mm	M30 P1.5	10mm	

CAUTION

Some machine tool builders may recommend the mono block type. Contact your machine builder and verify the proper style of coolant pipe to be selected. For machines capable of supplying coolant through the spindle, the Coolant Pipe should be fitted to all HSK holders to protect against accidental selection of coolant.

1° SWING TYPE—FORM A/E

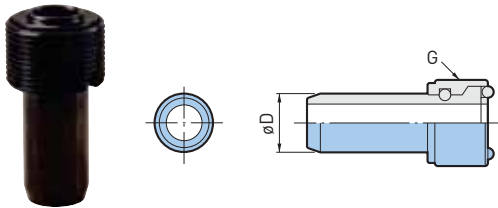

Catalog Number	øD	G	Wrench (Optional)	
HSK40-CPM	8mm	M12 P1	CPW-40	
HSK50-CPM	10mm	M16 P1	CPW-50	
HSK63-CPM	12mm	M18 P1	CPW-63	
HSK80-CPM	14mm	M20 P1.5	CPW-80	
HSK100-CPM	16mm	M24 P1.5	CPW-100	

CAUTION

DIN standard specifies ± 1 degree of float. For proper installation, the special wrench is necessary. For machines capable of supplying coolant through the spindle, the Coolant Pipe should be fitted to all HSK holders to protect against accidental selection of coolant.

HSK PLUG SCREW

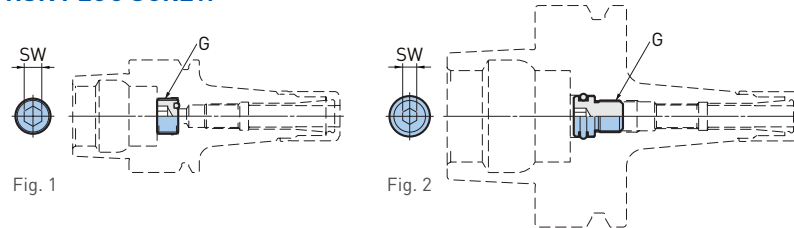

Catalog Number	Fig.	Body Type	G	SW
HSK25-PG	1	HSK-A25	M8xP1	4
		HSK-E25		
HSK32-PG		HSK-A32	M10xP1	5
		HSK-E32		
HSK40-PG		HSK-A40	M12xP1	6
		HSK-E40		
HSK-F63-PG	2	HSK-F63	M9xP0.75	4

- In case our HSK tool holders are used in a machine which does not recommend the center through coolant, the plug screw should be mounted to our tools
- HSK-F63-PG can only be used in original BIG DAISHOWA HSK-F63 tool holders, not compatible with other manufacturers

DYNA TEST

Helps identify potential problems, and can reduce downtime and costly repairs of the machine tool spindle.

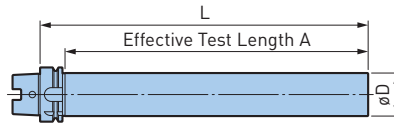

HSK Form	Catalog Number	L	A	øD	
A	HSK-A40-32-L180SD	7.087	6.181	32mm	
	HSK-A50-32-L150SD	5.905	4.764		
	-32-L240SD	9.449	8.307		
	A	HSK-A63-50-L200SD	7.874	6.732	50mm
		-50-L350SD	13.780	12.638	
		HSK-A100-50-L200SD	7.784	6.614	
		-50-L350SD	13.780	12.520	
E	HSK-E25-20-L175	6.890	6.417	20mm	
	HSK-E32-20-L180	7.087	6.220	32mm	
	HSK-E40-32-L180		6.181		
	HSK-E50-32-L240	9.449	8.307		
F	HSK-F63-50-L200	7.874	6.732	50mm	
	-50-L350	13.780	12.638		

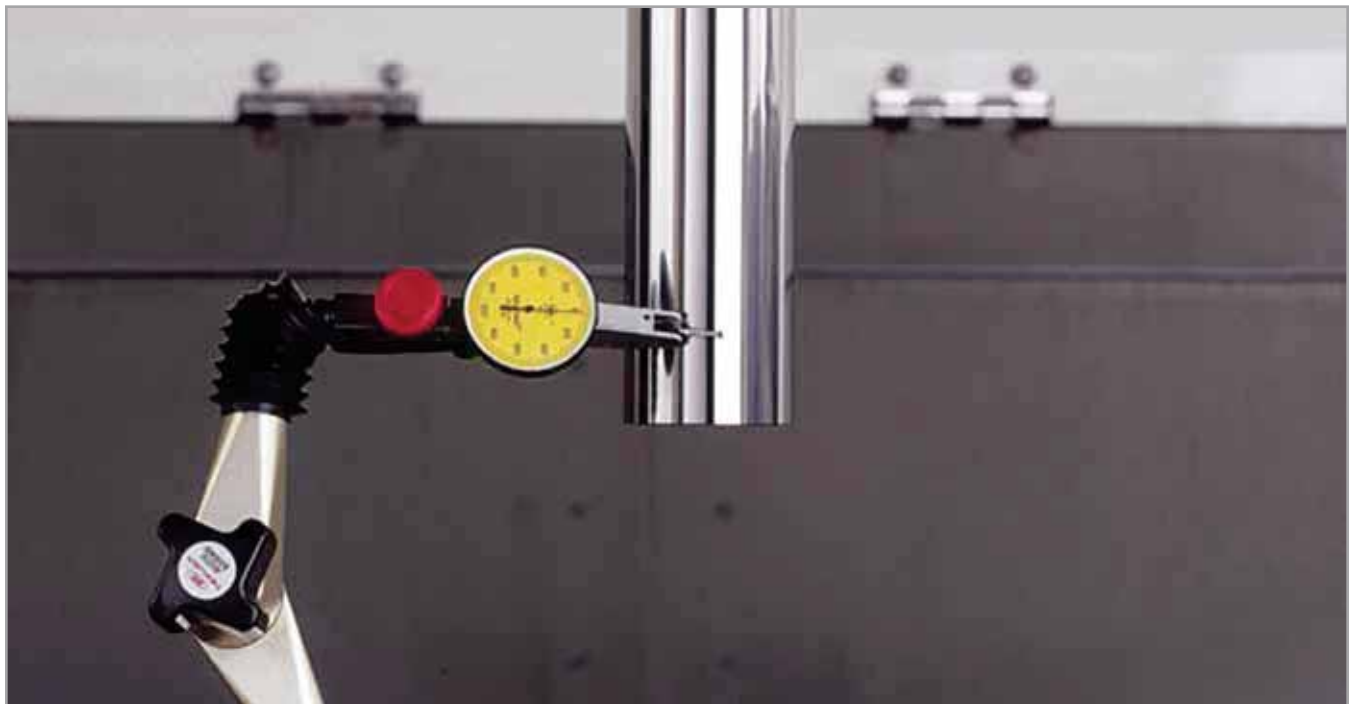

DUAL CONTACT C5/6/8

BIG CAPTO SHANK

BIG CAPTO A.4

A.4



COLLET CHUCKS	234-243
MEGA MICRO CHUCK	234-235
MEGA NEW BABY CHUCK	236-239
MEGA ER GRIP	240-241
MEGA E CHUCK	242-243
MILLING CHUCKS	244-247
MEGA DOUBLE POWER CHUCK	244-245
NEW Hi-POWER MILLING CHUCK	247
HYDRAULIC CHUCKS	248-249
BASIC ARBORS	250-255
SHRINK FIT HOLDER	250
SIDE LOCK ENDMILL HOLDER	251
SIDE CUTTER ARBOR A	251
MORSE TAPER HOLDER	252
JACOBS TAPER ARBOR	252
EXTENSIONS & REDUCTIONS	253
FACE MILL HOLDER	254-255
TAP HOLDERS	256
MEGA SYNCHRO TAPPING HOLDER	256
MODULAR HOLDERS	257-258
CKB SHANK	257
BIG KOMET ABS	258
ACCESSORIES	259
DYNA TEST	259
SPINDLE CLEANERS	259

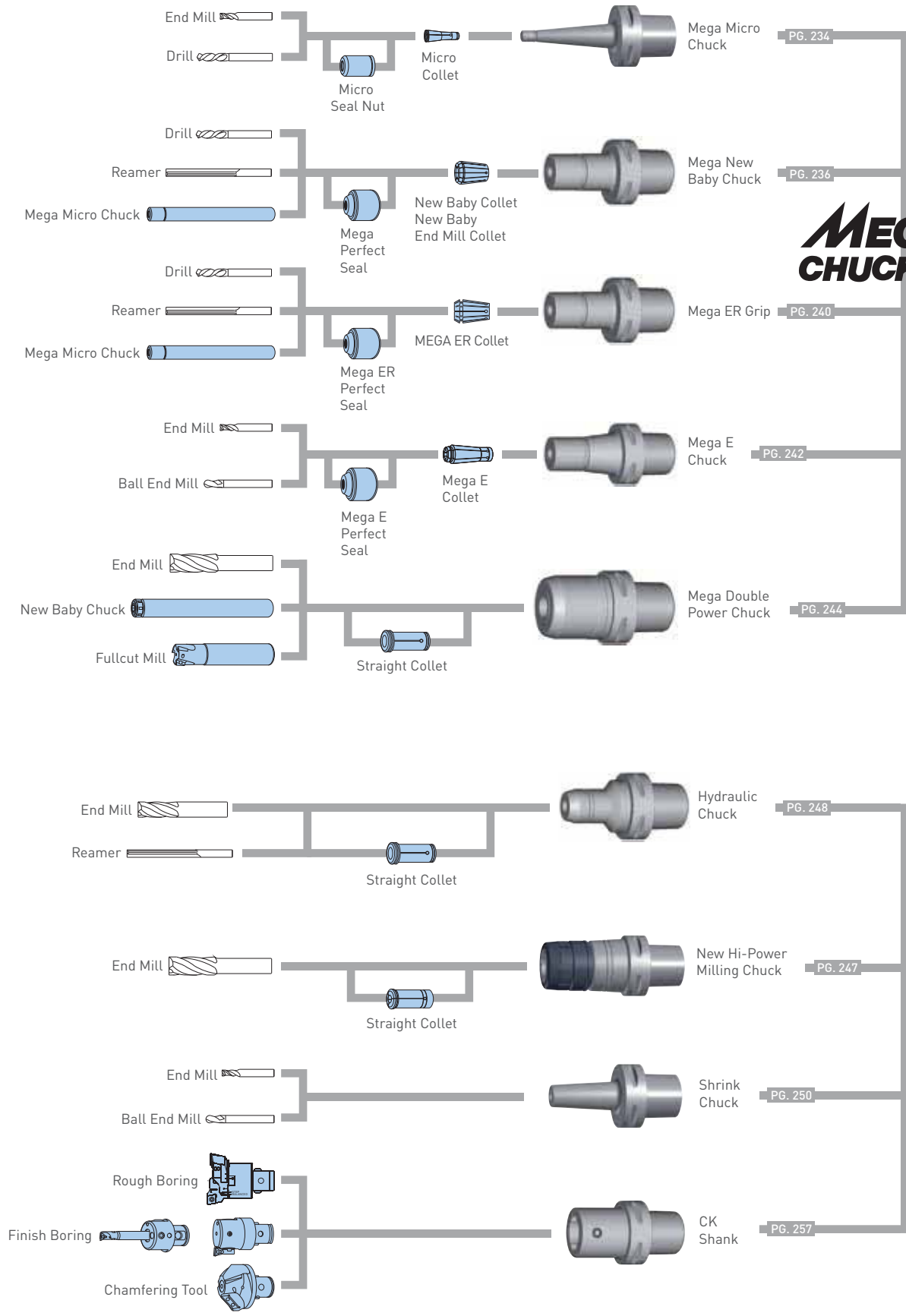

MEGA CHUCK SERIES

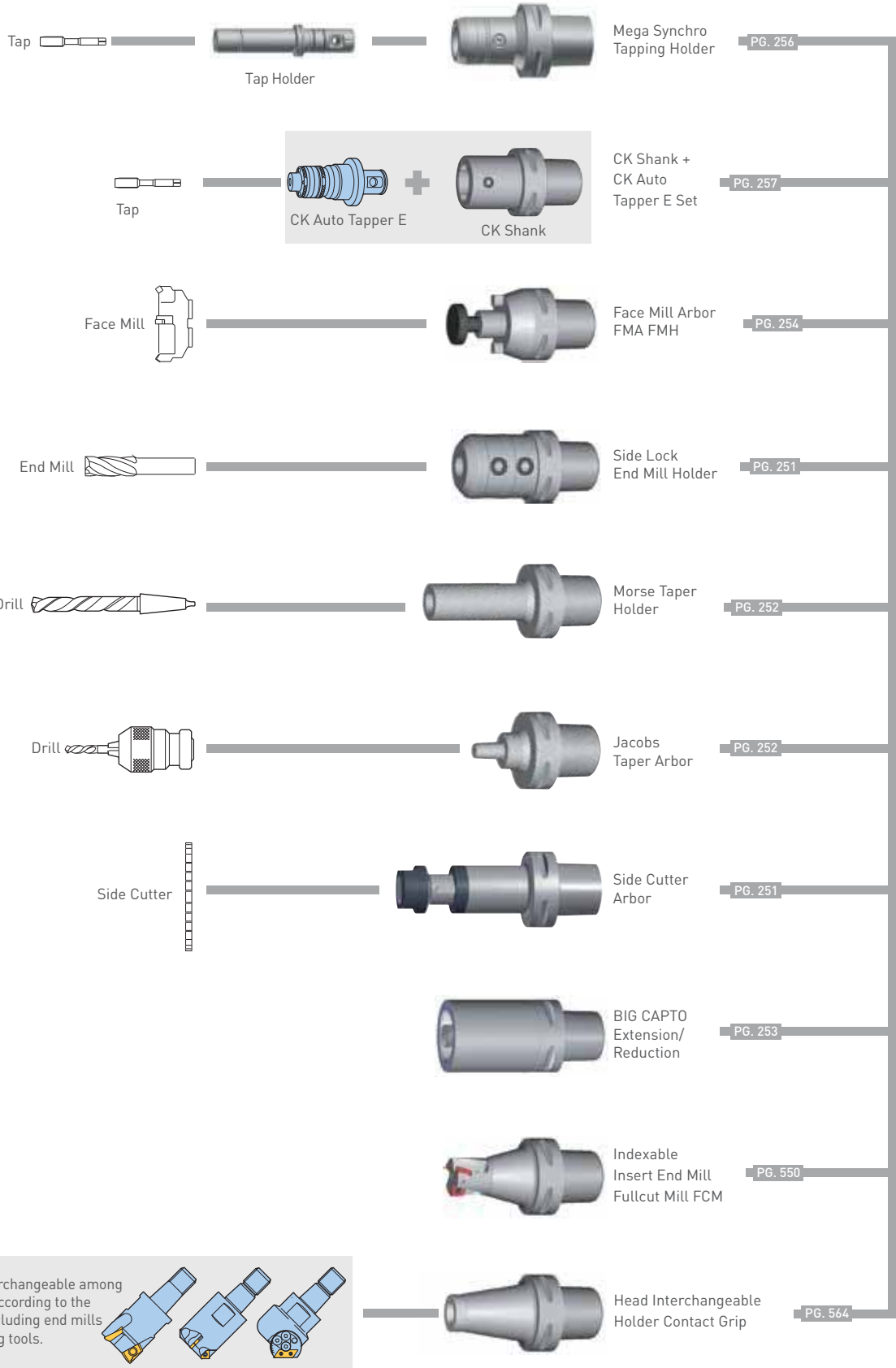

Heads are interchangeable among various tools according to the application, including end mills and chamfering tools.

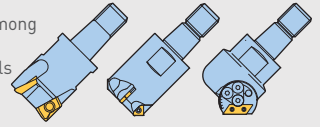

MEGA MICRO CHUCK

CLAMPING RANGE: $\varnothing.018$ "-.238" ($\varnothing.45$ -6.05mm)

For Micro Drill & End Mill Applications

HIGHER RIGIDITY

MAX 35,000 RPM

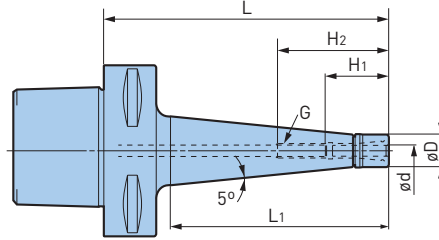

BIG CAPTO A.4

Catalog Number	$\varnothing d$	$\varnothing D$	L	L1	H1	H2	G	Collet	Nut	Wrench	Max RPM	Weight (lbs.)
C4-MEGA3S-60T	.018-.125	.394	2.36	1.38	.87	1.50	M4 P0.7	NBC3S-□	MGN3S	MGR10	35,000	.7
-MEGA6S-60T	.018-.238	.551	2.36	1.38	1.10	1.85	M7 P0.75	NBC6S-□	MGN6S	MGR14	30,000	.7
-MEGA6S-90T			3.54	2.56		1.89					22,000	.9
C5-MEGA3S-105T	.018-.128	.394	4.13	3.11	.89	1.52	M4 P0.7	NBC3S-□	MGN3S	MGR10	30,000	1.1
-MEGA4S-105T	.018-.159	.472	4.13	3.11	1.04	1.85	M5 P0.8	NBC4S-□	MGN4S	MGR12	25,000	1.1
-120T			4.72	3.70							20,000	1.3
-MEGA6S-105T	.018-.238	.551	4.13	3.11	1.12	1.93	M7 P0.75	NBC6S-□	MGN6S	MGR14	25,000	1.3
-120T			4.72	3.70							20,000	1.3
C6-MEGA3S-120T	.018-.128	.394	4.72	3.62	.89	1.52	M4 P0.7	NBC3S-□	MGN3S	MGR10	25,000	2.9
-MEGA4S-120T	.018-.159	.472	4.72	3.62	1.04	1.85	M5 P0.8	NBC4S-□	MGN4S	MGR12	22,000	2.9
-135T			5.31	4.21							20,000	3.1
-MEGA6S-120T	.018-.238	.551	4.72	3.62	1.12	1.93	M7 P0.75	NBC6S-□	MGN6S	MGR14	22,000	2.9
-135T			5.31	4.21							20,000	3.1

- MEGA MICRO NUT is included, collet and wrench must be ordered separately
- Weight includes nut but not collet
- Please note that the practical spindle speed may be considerably influenced by the machine rigidity and tool balance, when using, slowly ramp up to the appropriate speed starting from slow speeds

ACCESSORIES



MEGA MICRO CHUCK

CLAMPING RANGE: ϕ .018"-.238" (ϕ .45-6.05mm)

For Micro Drill & End Mill Applications

MAX
25,000
RPM

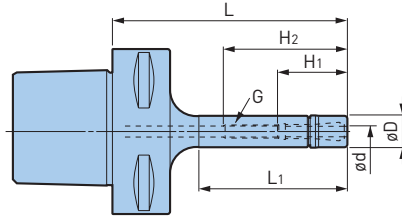

Catalog Number	ϕd	ϕD	L	L ₁	H ₁	H ₂	G	Collet	Nut	Wrench	Max RPM	Weight (lbs.)
C5-MEGA3S-75	.018-.128	.394	2.95	1.93	.89	1.50	M4 P0.7	NBC3S-□	MGN3S	MGR10	25,000	.9
-MEGA4S-75	.018-.159	.472		1.97	1.04	1.85	M5 P0.8	NBC4S-□	MGN4S	MGR12	25,000	.9
-MEGA6S-75	.018-.238	.551		1.97	1.12	1.93	M7 P0.75	NBC6S-□	MGN6S	MGR14	25,000	.9
C6-MEGA3S-90	.018-.128	.394	3.54	1.97	.89	1.50	M4 P0.7	NBC3S-□	MGN3S	MGR10	25,000	2.4
-MEGA4S-90	.018-.159	.472		2.28	1.04	1.85	M5 P0.8	NBC4S-□	MGN4S	MGR12	25,000	2.6
-MEGA6S-90	.018-.238	.551		2.28	1.12	1.93	M7 P0.75	NBC6S-□	MGN6S	MGR14	25,000	2.6

- MEGA MICRO NUT is included, collet and wrench must be ordered separately
- Weight includes nut but not collet
- Please note that the practical spindle speed may be considerably influenced by the machine rigidity and tool balance, when using, slowly ramp up to the appropriate speed starting from slow speeds

ACCESSORIES



MEGA NEW BABY CHUCK

CLAMPING RANGE: ϕ .010"-.787" (ϕ .25-20mm)

For Drills, Reamers, Taps & Finishing End Mills

MAX
35,000
RPM

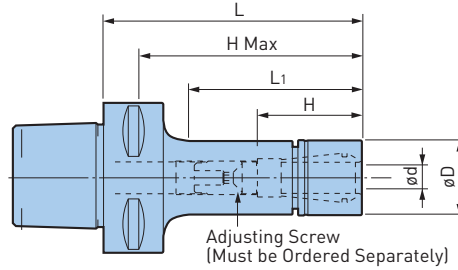
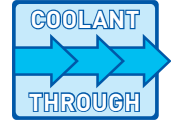

BIG CAPTO A.4

Catalog Number	ϕd	ϕD	L	L1	H	H Max	Collet	Nut	Wrench	Max RPM	Weight (lbs.)
C4-MEGA6N-75	.010-.236	.787	2.95	1.89	.91-1.69	2.72	NBC6-□	MGN6	MGR20	30,000	.9
-MEGA8N-75	.020-.315	.984	2.95	1.93	1.02-1.77	2.72	NBC8-□	MGN8	MGR25	30,000	1.1
-MEGA10N-50	.059-.394	1.181	1.97	1.10	1.73	1.73	NBC10-□	MGN10	MGR30	33,000	1.1
-75			2.95	2.05	1.50-1.89	2.72				30,000	1.3
-MEGA13N-50	.098-.512	1.378	1.97	1.14	1.73	1.73	NBC13-□	MGN13	MGR35	30,000	1.1
-75			2.95	2.13	2.52	2.52				28,000	1.5
-MEGA16N-55	.098-.630	1.654	2.17	—	1.89	1.89	NBC16-□	MGN16	MGR42	30,000	1.5
-MEGA20N-60	.098-.787	1.811	2.36	—	2.09	2.09	NBC20-□	MGN20	MGR46	25,000	1.8
C5-MEGA6N-60	.010-.236	.787	2.36	1.34	.91-1.42	2.09	NBC6-□	MGN6	MGR20	35,000	1.1
-75			2.95	1.93	.91-1.69	2.68				30,000	1.1
-90			3.54	2.44		3.27				30,000	1.1
-105			4.13	3.03		3.86				25,000	1.3
-120			4.72	3.54		4.45				23,000	1.3
-MEGA8N-60	.020-.315	.984	2.36	1.30		1.02-1.42	2.09	NBC8-□	MGN8	MGR25	35,000
-75			2.95	1.93	1.02-1.77	2.68	30,000				1.3
-90			3.54	2.52		3.27	30,000				1.3
-105			4.13	3.03		3.86	27,000				1.5
-120			4.72	3.62		4.45	25,000				1.5
-MEGA10N-55	.059-.394	1.181	2.17	1.22		1.89	1.89	NBC10-□	MGN10	MGR30	35,000
-75			2.95	1.93	1.50-1.89	2.68	33,000				1.3
-90			3.54	2.52		3.27	30,000				1.5
-105			4.13	3.11		3.86	27,000				1.8
-120			4.72	3.62		4.45	25,000				2.0
-MEGA13N-55	.098-.512	1.378	2.17	1.22		1.89	1.89	NBC13-□	MGN13	MGR35	30,000
-75			2.95	1.93	1.73-1.89	2.68	28,000				1.5
-90			3.54	2.52		3.27	25,000				1.8
-105			4.13	3.11		3.86	22,000				2.0
-120			4.72	3.70		4.45	20,000				2.2
-MEGA16N-60	.098-.630	1.654	2.36	1.50		2.09	2.09	NBC16-□	MGN16	MGR42	30,000
-75			2.95	2.09	2.68	2.68	28,000				2.0
-90			3.54	2.72	1.89-2.48	3.27	23,000				2.2
-105			4.13	3.31	1.89-2.68	3.86	20,000				2.4
-120			4.72	3.90		4.37	15,000				2.9

Catalog Number	ød	øD	L	L1	H	H Max	Collet	Nut	Wrench	Max RPM	Weight (lbs.)
C5-MEGA20N-60 ❖	.098-.787	1.811	2.36	1.54	2.01	2.01	NBC20-□	MGN20	MGR46	23,000	1.8
-75 ❖			2.95	2.13	2.60	2.60				20,000	2.2
-90			3.54	2.72	2.01-2.36	3.27				17,000	2.4
-105			4.13	3.31	2.01-2.68	3.86				15,000	2.9
-120			4.72	3.90		4.37				13,000	3.1
C6-MEGA6N-60	.010-.236	.787	2.36	1.18	.91-1.30	2.01	NBC6-□	MGN6	MGR20	35,000	2.6
-75			2.95	1.69	.91-1.69	2.60				35,000	2.6
-90			3.54	2.28		3.19				30,000	2.6
-105			4.13	2.87		3.78				30,000	2.9
-120			4.72	3.46		4.37				25,000	2.9
-135			5.31	4.06		4.96				20,000	2.9
-165			6.50	5.04		6.14				15,000	3.1
-200			7.87	6.42		7.52				10,000	3.3
-MEGA8N-60	.020-.315	.984	2.36	1.14	1.02-1.22	2.01	NBC8-□	MGN8	MGR25	35,000	2.9
-75			2.95	1.69	1.02-1.77	2.60				35,000	2.9
-90			3.54	2.28		3.19				30,000	2.9
-105			4.13	2.87		3.78				30,000	3.1
-120			4.72	3.46		4.37				25,000	3.1
-135			5.31	4.06		4.96				20,000	3.3
-165			6.50	5.24		6.14				15,000	3.5
-200			7.87	6.42		7.52				10,000	3.7
-MEGA10N-60 ❖	.059-.394	1.181	2.36	1.26	2.01	2.01	NBC10-□	MGN10	MGR30	35,000	2.9
-75			2.95	1.69	1.50-1.77	2.60				33,000	3.1
-90			3.54	2.28	1.50-1.89	3.19				30,000	3.1
-105			4.13	2.87		3.78				25,000	3.3
-120			4.72	3.46		4.37				25,000	3.5
-135			5.31	4.06		4.96				20,000	3.5
-165			6.50	5.24		6.14				15,000	4.0
-200			7.87	6.61		7.52				12,000	4.4
-MEGA13N-60 ❖	.098-.512	1.378	2.36	1.26	2.01	2.01	NBC13-□	MGN13	MGR35	35,000	2.9
-75 ❖			2.95	1.77	2.60	2.60				32,000	3.1
-90			3.54	2.36	1.73-2.17	3.19				30,000	3.3
-105			4.13	2.87	1.73-2.48	3.78				25,000	3.5
-120			4.72	3.54		4.37				20,000	3.7
-135			5.31	4.06		4.96				20,000	4.0
-165			6.50	5.24		6.14				15,000	4.4
-200			7.87	6.61		7.52				12,000	4.8

- MEGA NEW BABY NUT is included, collet, wrench and adjusting screw must be ordered separately
- Weight includes nut but not collet
- Center through coolant supply is available
- Please note that the practical spindle speed may be considerably influenced by the machine rigidity and tool balance, when using, slowly ramp up to the appropriate speed starting from slow speeds
- "H" dimension is the Max tool shank length that can be inserted into the holder
- Adjusting screws cannot be used with models marked ❖

ACCESSORIES



MEGA NEW BABY CHUCK

CLAMPING RANGE: ϕ .098"-.787"

For Drills, Reamers, Taps & Finishing End Mills

MAX
35,000
RPM

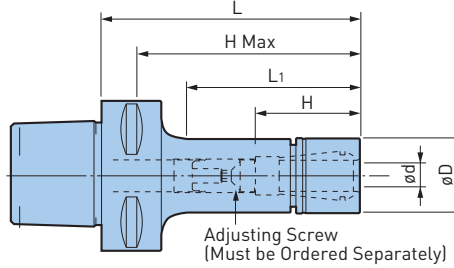
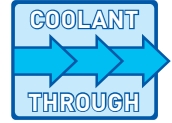

BIG CAPTO A.4

Catalog Number	ϕd	ϕD	L	L ₁	H	H Max	Collet	Nut	Wrench	Max RPM	Weight (lbs.)
C6-MEGA16N-65 ❖	.098-.630	1.654	2.56	1.46	2.20	2.20	NBC16-□	MGN16	MGR42	32,000	3.3
-75 ❖			2.95	1.85	2.60	2.60				30,000	3.5
-90			3.54	2.36	1.89-2.24	3.19				25,000	3.7
-105			4.13	2.95	1.89-2.68	3.78				20,000	4.0
-120			4.72	3.54		4.37				15,000	4.4
-135			5.31	4.13		4.96				15,000	4.6
-165			6.50	5.31		6.14				10,000	5.3
-200			7.87	6.69	7.52	8,000				5.9	
-MEGA20N-65 ❖	.098-.787	1.811	2.56	1.46	2.01	2.01	NBC20-□	MGN20	MGR46	32,000	3.3
-75 ❖			2.95	1.85	2.56	2.56				30,000	3.5
-90			3.54	2.44	2.01-2.20	2.99				25,000	4.0
-105			4.13	3.03	2.01-2.68	3.58				20,000	4.4
-120			4.72	3.62		4.09				15,000	4.6
-135			5.31	4.21		4.37				15,000	5.1
-165			6.50	5.39		4.37				10,000	5.7
-200			7.87	6.77	4.37	8,000				6.4	
C8-MEGA6N-90	.010-.236	.787	3.54	1.77	.91-1.69	3.54	NBC6-□	MGN6	MGR20	20,000	5.3
-120			4.72	2.95		4.72				17,000	5.7
-165			6.50	4.72		6.50				12,000	5.9
-MEGA8N-90	.020-.315	.984	3.54	1.81	1.02-1.77	3.54	NBC8-□	MGN8	MGR25	20,000	5.7
-120			4.72	2.95		4.72				17,000	5.9
-165			6.50	4.72		6.50				13,000	6.2
-MEGA10N-90	.059-.394	1.181	3.54	1.77	1.50-1.89	3.54	NBC10-□	MGN10	MGR30	20,000	5.9
-120			4.72	2.95		4.72				17,000	6.2
-165			6.50	4.72		6.50				13,000	6.6
-MEGA13N-90	.098-.512	1.378	3.54	1.97	1.73-2.48	3.54	NBC13-□	MGN13	MGR35	18,000	6.2
-120			4.72	3.15		4.72				15,000	6.4
-165			6.50	4.72		6.50				12,000	7.0
-200			200	155		7.87				8,000	7.7

Catalog Number	ød	øD	L	L ₁	H	H Max	Collet	Nut	Wrench	Max RPM	Weight (lbs.)
C8-MEGA16N-90	.098-.630	1.654	3.54	1.97	1.89-2.60	3.54	NBC16-□	MGN16	MGR42	15,000	6.4
-120			4.72	3.15	1.89-2.68	4.72				14,000	7.0
-165			6.50	4.92		6.50				13,000	7.9
-MEGA20N-90	.098-.787	1.811	3.54	1.97	2.01-2.68	3.27	NBC20-□	MGN20	MGR46	15,000	6.6
-120			4.72	3.15		4.45				14,000	7.3
-165			6.50	4.92		4.45				13,000	8.4
-200			7.87	6.30		4.45				10,000	9.0

- MEGA NEW BABY NUT is included, collet, wrench and adjusting screw must be ordered separately
- Weight includes nut but not collet
- Center through coolant supply is available
- Please note that the practical spindle speed may be considerably influenced by the machine rigidity and tool balance, when using, slowly ramp up to the appropriate speed starting from slow speeds
- "H" dimension is the Max tool shank length that can be inserted into the holder
- Adjusting screws cannot be used with models marked ❖

ACCESSORIES

 COLLET PG. 338	 MEGA NUT PG. 344	 PERFECT SEAL PG. 346	 MEGA WRENCH PG. 368	 SCREW PG. 389
---	---	---	--	--



COLLET CHUCKS

MEGA ER GRIP

CLAMPING RANGE: ϕ .075"-.787"

For Drills, Reamers, Taps & Finishing End Mills

MAX
33,000
RPM

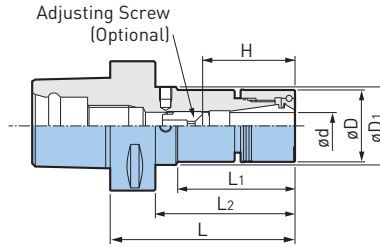
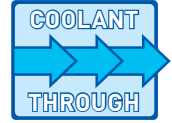

BIG CAPTO A.4

Catalog Number	ϕd	ϕD	$\phi D1$	L	L1	L2	H	Collet	Nut (NOT Included)	Wrench	Weight (lbs.)	
C5-MEGAER16-60NL ❖	.075-.394	1.181	1.378	2.36	1.10	1.58	2.09	ERC16-□	MERN16*	MGR30L	1.5	
-90NL				3.54	2.22	2.76	1.38-1.85				2.0	
-105NL				4.13	2.82	3.35					2.2	
-135NL				5.32	4.00	4.53					2.6	
-MEGAER20-60NL ❖	.108-.512	1.378	1.496	2.36	1.61	1.58	2.09	ERC20-□	MERN20*	MGR35L	1.8	
-90NL				3.54	2.28	2.76	1.65-2.44				2.0	
-105NL				4.13	2.84	3.35					2.2	
-135NL				5.32	4.02	4.53					2.9	
-MEGAER25-65NL ❖	.108-.630	1.654	—	2.56	—	1.77	2.28	ERC25-□	MERN25*	MGR42L	2.0	
-90NL				3.54		2.68	1.73-2.28				2.4	
-105NL				4.13		3.35	1.73-2.64				2.6	
-135NL				5.32		4.53					3.3	
-MEGAER32-70NL ❖	.108-.787	1.969	—	2.76	—	1.97	2.48	ERC32-□	MERN32*	MGR50L	2.2	
-90NL				3.54		2.76	1.97-2.32				2.6	
-105NL				4.13		3.35	1.97-2.68				3.1	
-135NL				5.32		4.53					4.0	
C6-MEGAER16-60NL ❖	.075-.394	1.181	1.378	2.36	1.10	1.50	2.01	ERC16-□	MERN16*	MGR30L	2.9	
-90NL				3.54	2.15	2.68	1.38-1.85				3.1	
-105NL				4.13	2.74	3.27					3.3	
-135NL				5.32	3.92	4.45					3.5	
-MEGAER20-65NL ❖	.108-.512	1.378	1.496	2.56	1.16	1.69	2.20	ERC20-□	MERN20*	MGR35L	2.9	
-90NL				3.54	2.17	2.68	1.65-2.28				3.3	
-105NL				4.13	2.76	3.27					1.65-2.44	3.5
-135NL				5.32	3.94	4.45						3.7
-165NL	6.50	5.12	5.63	4.2								
-MEGAER25-65NL ❖	.108-.630	1.654	—	2.56	—	1.69	2.20	ERC25-□	MERN25*	MGR42L	3.1	
-90NL				3.54		2.68	1.73-2.32				3.5	
-105NL				4.13		3.27	1.73-2.64				3.7	
-135NL				5.32		4.45					4.4	
-165NL	6.50	5.63	4.8									

Catalog Number	ød	øD	øD1	L	L1	L2	H	Collet	Nut (NOT Included)	Wrench	Weight (lbs.)
C6-MEGAER32-70NL❖	.108-.787	1.969	—	2.76	—	1.89	2.52	ERC32-□	MERN32*	MGR50L	3.3
-90NL				3.54		2.68	1.97-2.32				4.0
-105NL				4.13		3.27	1.97-2.68				4.2
-135NL				5.32		4.45					5.1
-165NL				6.50		5.63					5.7

***Nut, adjusting screw, balance screws, collet and wrench are not included**

- Weight does not include collet
- MEGA ER GRIP is not able to use DIN6499 Form-A collets and ESX collets
- Please note that the practical spindle speed may be considerably influenced by the machine rigidity and tool balance, when using, slowly ramp up to the appropriate speed starting from slow speeds
- "H" indicates the adjustment length with an adjusting screw
- Adjusting screws cannot be used with models marked ❖

CAUTION ⚠

To maintain the accuracy of the tool assembly, do not use collets and nuts manufactured by another company with the chuck body of BIG's MEGA ER GRIP. We cannot guarantee the accuracy statement for our collets if they are assembled on the chuck body of another manufacturer.

ACCESSORIES



*MEGA NUT is the recommended nut to achieve high accuracy and clamping force

High Concentricity



MEGA ER PERFECT SEAL



MEGA WRENCH

Capable of sealing high pressure coolant up to 7Mpa. For applications with coolant supplied through the tools. MEGA Wrench is used for tightening.



MEGA ER NUT*



MEGA WRENCH

High accuracy and clamping force are provided with thrust ball bearings. Ideal for solid carbide drills and reamers. Slot-free outer diameter increases rigidity of the nut itself. The one-way clutch of the MEGA Wrench tightens the nut securely and easily by ratchet function.



MEGA ER SOLID NUT



MEGA WRENCH

High performance solid nut with surface treatment for friction reduction. Slot-free outer diameter increases rigidity of the nut itself. The one-way clutch of the MEGA Wrench tightens the nut securely and easily by ratchet function.



ER NUT



C-SPANNER

Basic nut with surface treatment for friction reduction. C-Spanner is used for tightening.

*MEGA NUT is the recommended nut to achieve high accuracy and clamping force

MEGA E CHUCK

CLAMPING RANGE: ϕ .125"-.500" (ϕ 3-12mm)

Exclusively for High Speed Finish End Milling

MAX
35,000
RPM

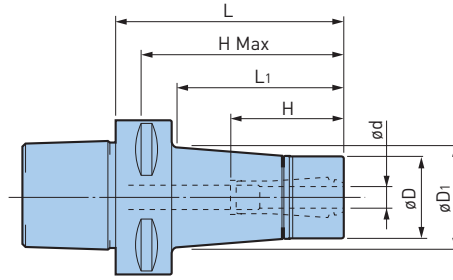
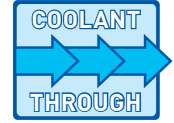

BIG CAPTO A.4

Catalog Number	ϕd	ϕD	$\phi D1$	L	L1	H	H Max	Collet	Nut	Wrench	Max RPM	Weight (lbs.)
C4-MEGA6E-50❖	.125-.250 (3-6mm)	.984	1.02	1.97	.98	1.73	1.73	MEC6-□	MEN6	MGR25	35,000	.9
-MEGA8E-50❖	.125-.250 (3-8mm)	1.181	1.22	1.97	1.10	1.73	1.73	MEC8-□	MEN8	MGR30	35,000	1.1
-MEGA10E-55❖	.125-.375 (3-10mm)	1.378	1.46	2.17	1.34	1.93	1.93	MEC10-□	MEN10	MGR35	30,000	1.1
-MEGA13E-60❖	.125-.500 (3-12mm)	1.654	—	2.36	—	1.97	1.97	MEC13-□	MEN13	MGR42	25,000	1.3
C5-MEGA6E-55❖	.125-.250 (3-6mm)	.984	1.04	2.17	1.14	1.89	1.89	MEC6-□	MEN6	MGR25	35,000	1.1
-90			1.27	3.54	2.52	1.46-1.77	3.27				25,000	1.5
-105			1.39	4.13	3.19		3.86				22,000	1.8
-120			1.49	4.72	3.82		4.45				20,000	2.0
-MEGA8E-55❖	.125-.250 (3-8mm)	1.181	1.23	2.17	1.22	1.89	1.89	MEC8-□	MEN8	MGR30	35,000	1.3
-90			1.47	3.54	2.64	1.65-2.01	3.27				25,000	1.8
-105			1.58	4.13	3.23		3.86				22,000	2.2
-120			1.69	4.72	3.86		4.45				20,000	2.4
-MEGA10E-60❖	.125-.375 (3-10mm)	1.378	1.47	2.36	1.46	2.09	2.09	MEC10-□	MEN10	MGR35	30,000	1.3
-90			1.68	3.54	2.72	1.89-2.28	3.27				25,000	2.0
-105			1.78	4.13	3.31		3.86				20,000	2.4
-120			1.78	4.72	3.90		4.45				18,000	2.9
-MEGA13E-60❖	.125-.500 (3-12mm)	1.654	1.75	2.36	1.54	1.97	1.97	MEC13-□	MEN13	MGR42	30,000	1.8
-75❖			1.77	2.95	2.13	2.68	2.68				25,000	2.0
-90			1.76	3.54	2.72	1.97-2.36	3.27				25,000	2.4
-105			1.81	4.13	3.31		3.86				20,000	2.9
-120			1.80	4.72	3.90		4.45				16,000	3.1
C6-MEGA6E-60❖	.125-.250 (3-6mm)	.984	1.10	2.36	1.30	2.01	2.01	MEC6-□	MEN6	MGR25	35,000	2.6
-75			1.16	2.95	1.89	1.46-1.77	2.06				30,000	2.9
-90			1.26	3.54	2.48		3.19				30,000	3.1
-105			1.37	4.13	3.07		3.78				28,000	3.3
-120			1.47	4.72	3.66		4.37				25,000	3.5
-135			1.57	5.31	4.25		4.96				22,000	4.0
-165			1.78	6.50	5.43		6.14				18,000	4.6

Catalog Number	ød	øD	øD1	L	L1	H	H Max	Collet	Nut	Wrench	Max RPM	Weight (lbs.)
C6-MEGA8E-60 ❖	.125-.250 (3-8mm)	1.181	1.29	2.36	1.30	2.01	2.01	MEC8-□	MEN8	MGR30	32,000	2.9
-75			1.35	2.95	1.89	1.65-1.81	2.60				30,000	3.1
-90			1.44	3.54	2.48	1.65-2.01	3.19				30,000	3.3
-105			1.56	4.13	3.07		3.78				28,000	3.7
-120			1.66	4.72	3.66		4.37				25,000	4.0
-135			1.76	5.31	4.25		4.96				23,000	4.2
-165			1.98	6.50	5.51		6.14				20,000	5.3
-MEGA10E-65 ❖			.125-.375 (3-10mm)	1.339	1.51		2.56				1.50	2.20
-75 ❖	1.54	2.95			1.89	2.60	2.60	30,000	3.3			
-90	1.64	3.54			2.48	1.89-2.28	3.19	30,000	3.5			
-105	1.75	4.13			3.07		3.78	27,000	4.0			
-120	1.85	4.72			3.66		4.37	23,000	4.4			
-135	1.97	5.31			4.33		4.96	20,000	4.8			
-165	2.18	6.50			5.55		6.14	17,000	5.9			
-MEGA13E-65 ❖	.125-.500 (3-12mm)	1.654			1.78		2.56	1.54	2.20	2.20	MEC13-□	MEN13
-75 ❖			1.81	2.95	1.93	2.60	2.60	30,000	3.5			
-90			1.93	3.54	2.60	1.97-2.17	3.19	28,000	4.0			
-105			2.02	4.13	3.15		3.78	25,000	4.6			
-120			2.13	4.72	3.78		4.37	22,000	5.1			
-135			2.24	5.31	4.41		4.96	18,000	5.7			
-165			2.45	6.50	5.55		6.14	15,000	7.0			
C8-MEGA6E-90			.125-.250 (3-6mm)	.984	1.21		3.54	2.17	1.46-1.77	3.54		
-135	1.52	5.31			3.94	5.31	14,000	6.6				
-MEGA8E-90	.125-.250 (3-8mm)	1.181	1.39	3.54	2.17	1.65-2.01	3.54	MEC8-□	MEN8	MGR30	20,000	5.9
-135			1.70	5.31	3.94		5.31				16,000	7.0
-MEGA10E-90	.125-.375 (3-10mm)	1.378	1.59	3.54	2.17	1.89-2.28	3.54	MEC10-□	MEN10	MGR35	20,000	6.2
-120			1.81	4.72	3.35		4.72				20,000	7.1
-135			1.90	5.31	3.94		5.31				16,000	7.5
-MEGA13E-90	.125-.500 (3-12mm)	1.654	1.85	3.54	2.17	1.94-2.36	3.54	MEC13-□	MEN13	MGR42	18,000	6.6
-120			2.07	4.72	3.35		4.72				17,000	7.5
-135			2.16	5.31	3.94		5.31				14,000	8.1
-165			2.38	6.50	5.12		6.50				12,000	9.5

- MEGA E NUT is included, collet, wrench and adjusting screw must be ordered separately
- Weight includes nut but not collet
- Center through coolant supply is available
- Please note that the practical spindle speed may be considerably influenced by the machine rigidity and tool balance, when using, slowly ramp up to the appropriate speed starting from slow speeds
- "H" indicates the adjustment length with an adjusting screw
- Adjusting screws cannot be used with models marked ❖

ACCESSORIES



MEGA DOUBLE POWER CHUCK

CLAMPING RANGE: ϕ .625"-1.250" (ϕ 16-32mm)

For Heavy Duty End Milling

MAX
30,000
RPM

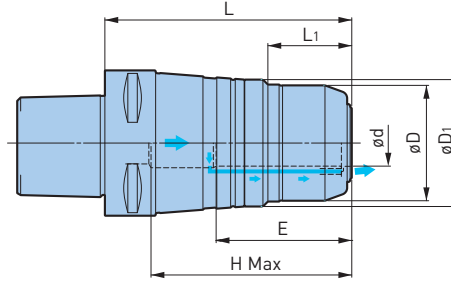
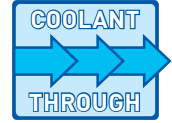

BIG CAPTO
A.4

Catalog Number	ϕd	ϕD	$\phi D1$	L	L1	H	Min Clamping Length E	Wrench	Max RPM	Weight (lbs.)
C5-MEGA16DS-65A	16mm	1.654	2.087	2.65	1.02	2.36	2.24	MGR42	30,000	2.0
-90A				3.64		2.87			28,000	3.1
-MEGA20DS-75A	20mm	1.969	2.165	3.05	1.42	2.76	2.28	MGR50L	30,000	2.6
-90A				3.64		3.35			28,000	3.3
-MEGA25DS-75A	25mm	2.441	2.480	3.05	1.42	2.76	2.32	MGR62L	25,000	3.1
-90A				3.64		3.35			22,000	3.7
C6-MEGA.625DS-3A	.625	1.654	2.193	3.09	1.02	2.48	2.05	MGR42L	30,000	3.7
-MEGA.750DS-3A	.750	2.165	2.193	3.09	1.42	2.68	2.28	MGR50L	30,000	4.4
-MEGA1.000DS-3A	1.000	2.441	2.469	3.09	1.42	2.68	2.28	MGR62L	28,000	4.6
-MEGA1.250DS-3.5A	1.250	2.756	2.783	3.59	1.46	3.27	2.64	MGR70L	25,000	5.5
-MEGA16DS-70A	16mm	1.654	2.087	2.85	1.02	2.48	2.24	MGR42L	30,000	3.7
-90A				3.64		3.27			28,000	4.6
-105A●				4.23		2.87			25,000	5.3
-135A●				5.41					22,000	6.6
-MEGA20DS-75A	20mm	1.969	2.165	3.05	1.42	2.68	2.28	MGR50L	30,000	4.4
-90A				3.64		3.27			28,000	4.8
-105A				4.23		3.43			25,000	5.5
-135A❖				5.41		2.80-3.19			22,000	6.8
-MEGA25DS-75A◆	25mm	2.441	2.480	3.05	1.42	2.68	2.32	MGR62L	28,000	4.6
-90A				3.64		3.27			25,000	5.3
-105A				4.23		3.43			23,000	6.2
-135A❖				5.41		2.87-3.27			20,000	7.3
-MEGA32DS-90A	32mm	2.756	2.795	3.64	1.46	3.27	2.60	MGR70L	25,000	5.5
-105A				4.23		3.62			22,000	6.4
-135A❖				5.41		3.19-3.58			18,000	7.5

Catalog Number	ød	øD	øD1	L	L1	H	Min Clamping Length E	Wrench	Max RPM	Weight (lbs.)
C8-MEGA1.250DS-3.5	1.250	3.150	3.386	3.59	1.65	3.62	2.80	MGR80L	20,000	9.5
-MEGA16DS-70	16mm	1.811	2.193	2.85	.98	2.87	2.05	MGR46L	25,000	6.2
-105●				4.23					20,000	7.9
-135●				5.41					18,000	9.0
-MEGA20DS-75				3.05					25,000	7.3
-135❖	20mm	2.362	2.717	5.41	1.10	2.80-3.19	2.28	MGR60L	18,000	11.0
-165❖				6.59					15,000	13.0
-MEGA25DS-75	25mm	2.756	3.031	7.97	1.34	3.03	2.64	MGR70L	21,000	7.5
-135❖				5.41					15,000	11.9
-165❖				6.59					12,000	14.1
-MEGA32DS-90				3.64					18,000	9.5
-105	32mm	3.150	3.386	4.23	1.65	4.02	2.87	MGR80L	17,000	10.6
-135				5.41					15,000	13.2
-165❖				6.59					12,000	16.1
				3.15-3.82					4.21	

- Wrench must be ordered separately
- Jet-through type provides coolant form the chuck nose, thus tools with oil holes cannot be used
- Models marked ❖ can be used with optional axial adjusting screws
- M8 hex screw is required with models marked ●
- Adjusting screw can only be used with models marked ● or ❖, please contact us if using for center through applications
- Models marked ◆ can only be used with straight collet model C25-□□

ACCESSORIES

 <p>COLLET PG. 364</p>	 <p>PERFECT SEAL/ JET COLLET PG. 361</p>	 <p>MEGA WRENCH PG. 368</p>	 <p>SCREW PG. 390</p>
---	---	--	--



NEW Hi-POWER MILLING CHUCK

CLAMPING RANGE: $\varnothing 16-32\text{mm}$

For Heavy Duty End Milling

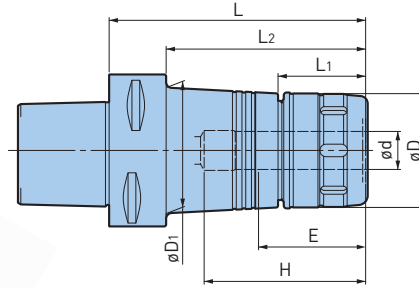
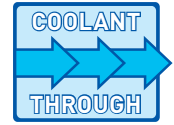

Catalog Number	$\varnothing d$	$\varnothing D$	$\varnothing D1$	L	L1	L2	H	Min Clamping Length E	Wrench	Weight (lbs.)
C5-HMC16S-65	16mm	1.693	—	2.56	1.73	1.77	2.28	2.17	NBK20	1.8
-HMC20S-75	20mm	1.969	—	2.95	1.73	—	2.68	2.20	FK45-50L	2.2
-105			—	4.13		—	3.35			3.1
-HMC25S-75◆	25mm	2.165	—	2.95	1.85	—	2.68	2.24	FK52-55	2.9
-105			—	4.13		—	3.43			3.7
-HMC32S-85	32mm	2.441	—	3.35	2.20	—	3.07	2.28	FK58-62L	3.5
C6-HMC16S-70	16mm	1.693	—	2.76	1.73	1.89	2.40	2.17	FK45-50L	3.3
-HMC20S-75	20mm	1.969	—	2.95	1.73	2.09	2.60	2.20	FK45-50L	3.7
-105			—	4.13		3.27	3.35			5.1
-120❖			—	4.72		3.86	2.72-3.11			5.5
-HMC25S-75◆	25mm	2.323	—	2.95	1.77	2.09	2.60	2.24	FK58-62L	4.4
-105			—	4.13		3.27	3.43			5.5
-135❖			—	5.31		4.45	2.87-3.27			6.8
-HMC32S-90	32mm	2.677	—	3.54	2.13	—	3.19	2.52	FK68-75L	5.3
-105			—	4.13		—	3.54			6.0
-135❖			—	5.31		—	3.11-3.50			7.3
C8-HMC20-80	20mm	2.362	—	3.15	1.81	1.97	3.15	2.20	FK58-62	7.3
-135❖			2.60	5.31		4.13	2.72-3.11			10.4
-HMC25-85	25mm	2.441	—	3.35	2.17	—	3.35	2.56	FK58-62	7.7
-135❖			2.64	5.31		4.13	2.99-3.39			10.4
-HMC32-95	32mm	3.150	—	3.74	2.48	—	3.74	2.80	FK80-90	9.9
-135			—	5.31		—	4.13			12.8

- Wrench must be ordered separately
- Models marked ❖ can be used with optional axial adjusting screws
- Models marked ◆ can only be used with straight collet model C25-□□

ACCESSORIES

<p>COLLET PG. 364</p>	<p>PERFECT SEAL/ JET COLLET PG. 361</p>	<p>WRENCH PG. 367</p>	<p>SCREW PG. 390</p>
---------------------------	---	---------------------------	--------------------------

HYDRAULIC CHUCKS

CLAMPING RANGE: $\varnothing 6$ -32mm

For Drills, Reamers, Ball Mills, End Mills, Diamond Reamers & Grinding Tools

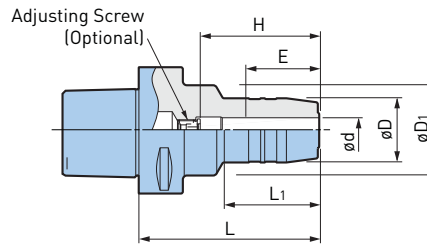
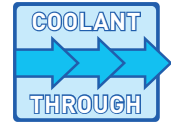

BIG CAPTO A.4

Catalog Number	$\varnothing d$	$\varnothing D$	$\varnothing D_1$	L	L ₁	H	Min Clamping Length E	Adjusting Screw	Weight (lbs.)
C5-HDC6-55 ❖	6mm	1.024	1.772	2.17	.71	1.89	1.10	—	1.8
-90				3.54	1.77	1.30-1.97		HDA6-05020	2.2
-HDC8-55 ❖	8mm	1.102	1.772	2.17	.71	1.89	1.10	—	1.8
-90				3.54	1.77	1.30-1.97		HDA8-06020	2.4
-HDC10-60 ❖	10mm	1.181	1.772	2.36	.94	2.09	1.30	—	2.0
-90				3.54	1.77	1.69-2.17		HDA10-08015	2.4
-HDC12-60 ❖	12mm	1.260	1.811	2.36	.94	2.09	1.50	—	2.0
-90			1.772	3.54	1.89	2.09-2.36		HDA12-10010●	2.4
-HDC14-90	14mm	1.339	1.772	3.58	1.89	1.50	2.09-2.36	HDA12-10010●	2.4
-HDC16-75 ❖	16mm	1.496	1.969	2.95	1.38	2.68	1.69	—	2.4
-90 ❖			1.890	3.54	1.89	3.27		—	2.7
-HDC18-90 ❖	18mm	1.575	1.890	3.54	1.89	1.69	3.27	—	2.7
-HDC20-75 ❖	20mm	1.654	2.047	2.95	1.38	2.68	1.69	—	2.4
-90 ❖			1.969	3.54	1.89	3.27		—	2.7
-HDC25-90 ❖	25mm	2.165	2.480	3.54	1.89	3.27	2.05	—	3.8
C6-HDC6-60 ❖	6mm	1.024	1.772	2.36	.71	2.01	1.10	—	3.1
-90				3.54	1.89	1.30-1.97		HDA6-05020	3.3
-120				4.72	1.77	1.10-1.97		HDA6-05032	4.0
-HDC8-60 ❖	8mm	1.102	1.772	2.36	.71	2.01	1.10	—	3.1
-90				3.54	1.89	1.30-1.97		HDA8-06020	3.5
-120				4.72	1.77	1.10-1.97		HDA8-06032	4.0
-HDC10-65 ❖	10mm	1.181	1.772	2.56	1.94	2.20	1.30	—	3.1
-90				3.54	1.89	1.69-2.17		HDA10-08015	3.5
-120				4.72	1.77	1.30-2.13		HDA10-08032	4.0
-HDC12-65 ❖	12mm	1.260	1.811	2.56	1.94	2.20	1.50	—	3.3
-90			1.772	3.54	1.89	1.89-2.36		HDA10-08015	3.5
-120			4.72	1.89	1.50-2.36	HDA10-08032		4.0	
-HDC14-90	14mm	1.339	1.772	3.54	1.89	1.89-2.36	1.50	HDA10-08015	3.5
-120				4.72	1.89	1.50-2.36		HDA10-08032	4.2
-HDC16-75 ❖	16mm	1.496	1.969	2.95	1.38	2.60	1.69	—	3.5
-90 ❖			1.850	3.54	1.89	3.19		—	3.8
-120			1.890	4.72	1.89	1.69-2.76		HDA16-12037	4.4

Catalog Number	∅d	∅D	∅D ₁	L	L ₁	H	Min Clamping Length E	Adjusting Screw	Weight (lbs.)
C6-HDC18-90 ❖	18mm	1.575	1.890	3.54	1.89	1.69	2.60	—	3.7
-120			1.929	4.72			1.69-2.76	HDA16-12037	4.4
-HDC20-75 ❖	20mm	1.654	2.087	2.95	1.30	2.60	1.69	—	3.8
-90			1.969	3.54	1.89	2.83		HDA16-12037	4.0
-120				4.72		1.69-2.76			4.6
-HDC25-90 ❖			25mm	2.165	2.480	3.54		1.81	3.15
-120	4.72	2.01				2.64-3.11	HDA20-16015	6.2	
-HDC32-90 ❖	32mm	2.953	2.480	3.54	1.69	3.19	2.20	—	6.2
-120		2.480	—	4.72	—	2.60-3.07		HDA20-160315	6.6

- "H" indicates the adjustment length with an adjusting screw
- "H" dimension is the Max tool shank length that can be inserted into the holder
- Do not attempt to balance before first consulting BIG KAISER
- In case the projection length needs to be adjusted from the shank side, add the letter "W" to adjusting screw model number for hexagon sockets on both sides (ex: HDA6-05020W)
- The above type is not available for HDA12-10010 with models marked ●
- Adjusting screws cannot be used with models marked ❖

ACCESSORIES



CAUTION ⚠

Use only cutting tools that have a shank tolerance of h6 (see table Pg. 26). Do not use with cutting tools made with a flat on the shank (ie: Weldon type shank). Roughing end mills are not recommended for use with HYDRAULIC CHUCKS. Do not tighten the clamping screw without first inserting a cutting tool into the tool holder. Always insert the cutting tool into the hydraulic tool holder beyond min. clamping length "E".



SHRINK FIT HOLDER—STANDARD TYPE

CLAMPING RANGE: $\phi 6$ -20mm

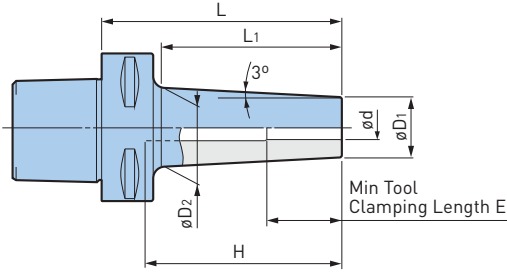
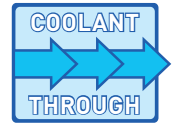

Catalog Number	ϕd	ϕD	ϕD_1	L	L1	Min Clamping Length E	H	Weight (lbs.)
C6-SRC6-90	6mm	.551	.807	3.54	2.48	1.02	3.19	2.6
-SRC8-90	8mm	.709	.965			1.02		2.9
-SRC10-90	10mm	.866	1.122			1.26		2.9
-SRC12-90	12mm	.945	1.201			1.42		3.1
-SRC16-90	16mm	1.102	1.358			1.50		3.1
-165	16mm	1.102	1.669	6.50	5.43	1.50	3.15	4.6
-SRC20-90	20mm	1.339	1.594	3.54	2.48	1.65	3.15	3.3
-165	20mm	1.339	1.906	6.50	5.43		3.94	5.5

- Use carbide cutter within a tolerance of h6
- HSS tools cannot be used

CAUTION

Please refer to the operation manual of heating/cooling equipment, as some equipment may not be compatible.

SHRINK FIT HOLDER—SLIM TYPE

CLAMPING RANGE: $\phi 6$ mm-12mm

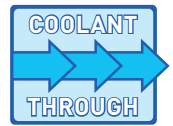

Catalog Number	ϕd	ϕD	ϕD_1	L	L1	Min Clamping Length E	H	Weight (lbs.)
C6-SRC6S-120	6mm	.394	.77	4.72	3.62	1.02	4.37	2.6
-165			.94	6.50	5.24		6.14	3.1
-SRC8S-120	8mm	.512	.89	4.72	3.62	1.02	4.37	2.9
-165			1.06	6.50	5.24		6.14	3.3
-SRC10S-120	10mm	.630	1.00	4.72	3.62	1.26	4.37	2.9
-165			1.20	6.50	5.31		6.14	3.3
-SRC12S-120	12mm	.748	1.12	4.72	3.62	1.42	4.37	3.1
-165			1.30	6.50	5.31		6.14	3.5

- Use carbide cutter within a tolerance of h6
- HSS tools cannot be used

CAUTION

Please refer to the operation manual of heating/cooling equipment, as some equipment may not be compatible.

SIDE LOCK ENDMILL HOLDER

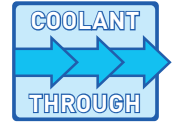
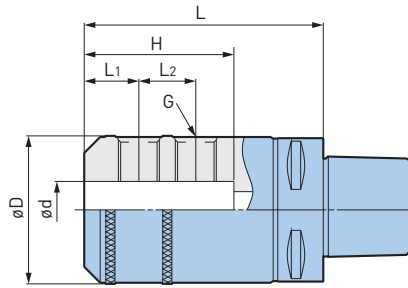

Catalog Number	ød	øD	L	L1	L2	H	G	Weight (lbs.)
C6-ISL16-80	16mm	1.890	3.15	.94	—	2.05	M14	4.0
-ISL20-80	20mm	2.047	3.15	.98		2.17	M16	4.2
-ISL25-105	25mm	2.559	4.13	.94	.98	2.36	M18 P2.0	6.4
-ISL32-115	32mm	2.835	4.53	.94	1.10	3.54	M20 P2.0	7.7

- Center through coolant supply is available

SIDE CUTTER ARBOR A

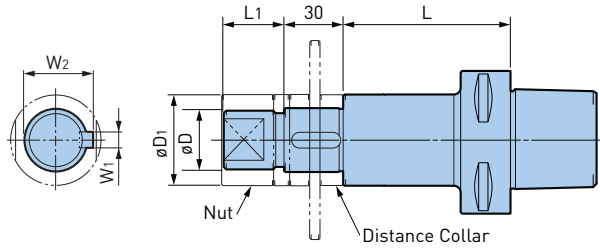

Catalog Number	øD	øD1	L	L1	W1	W2	Weight (lbs.)
C6-SCA25.4-75	1.000	1.575	2.95	.98	.25	1.09	4.4
-120			4.72				5.3
-SCA31.75-75	1.250	1.811	2.95	1.18	.31	1.37	5.3
C8-SCA25.4-90	1.000	1.575	3.54	.98	.25	1.09	7.3
-SCA31.75-90	1.250	1.811	3.54	1.18	.31	1.37	8.2

- Nut and collars of thickness 5, 8, 10 and 12 are included
- The model, dimensions and accuracy conform to TMT standards

MORSE TAPER HOLDER

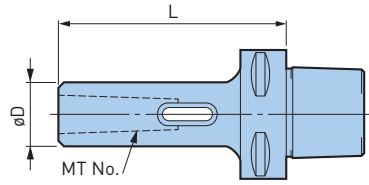

Catalog Number	MT No.	øD	L	Weight (lbs.)
C5-MTA1-95	1	.984	3.74	1.3
-MTA2-110	2	1.260	4.33	1.8
-MTA3-130	3	1.575	5.12	2.6
C6-MTA1-95	1	.984	3.74	2.9
-MTA2-110	2	1.260	4.33	3.3
-MTA3-130	3	1.575	5.12	4.2
C8-MTA1-105	1	.984	4.13	5.7
-MTA2-120	2	1.260	4.72	6.2
-MTA3-140	3	1.575	5.51	7.1

• The model, dimensions and accuracy conform to TMT standards

JACOBS TAPER ARBOR

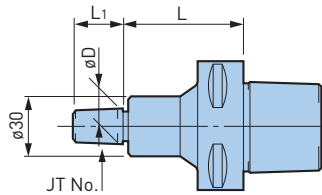

Catalog Number	JT No.	øD	L	L1	Weight (lbs.)
C5-JTA6-40	6	.676	1.57	.94	1.1
C6-JTA6-40	6	.676	1.57	.94	2.6
C8-JTA6-50	6	.676	1.97	.94	5.5

• The model, dimensions and accuracy conform to TMT standards

EXTENSION

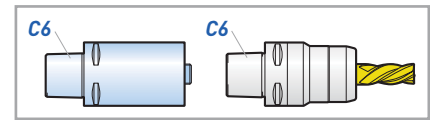
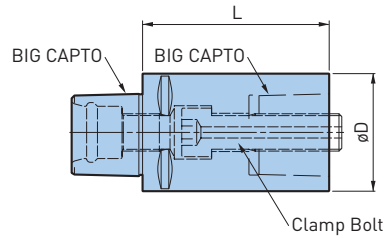

Catalog Number	BIG CAPTO	øD	L	Clamp Bolt			Weight (lbs.)
				Thread Size	Hex.	Tightening Torque	
C6-C6-100	C6	2.480	3.94	M20xP2	14mm	125 ft.-lbs.	2.6
C8-C8-100	C8	3.150	3.94	M20xP2	14mm	125 ft.-lbs.	3.7

- Clamping screws are included, wrench must be ordered separately
- When used for turning tools, connect by aligning with the phase of the hole on the taper shank

REDUCTION

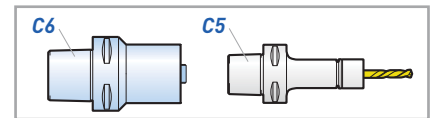
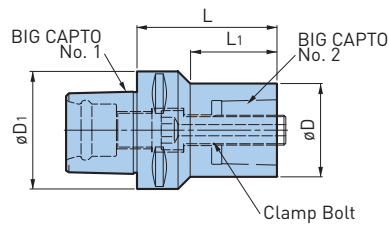

Catalog Number	BIG CAPTO No. 1	BIG CAPTO No. 2	øD	øD1	L	L1	Clamp Bolt			Weight (lbs.)
							Thread Size	Hex.	Tightening Torque	
C6-C5-75	C6	C5	1.969	2.480	2.95	1.81	M16xP1.5	10mm	95N·m	1.1
C8-C6-85	C8	C6	2.480	3.150	3.35	1.97	M20xP2	14mm	170N·m	1.8

- Clamping screws are included, wrench must be ordered separately
- When used for turning tools, connect by aligning with the phase of the hole on the taper shank

FACE MILL HOLDER

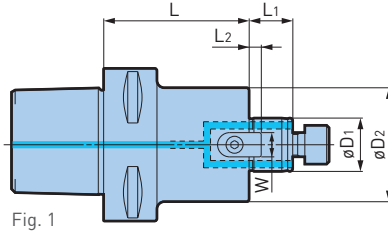
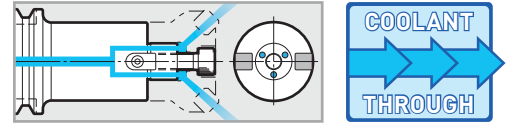

Fig. 1

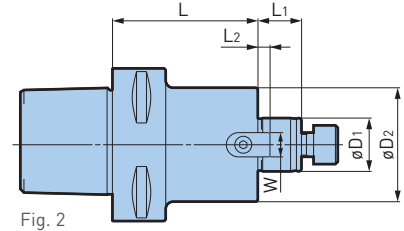

Fig. 2

BIG CAPTO A.4

Catalog Number	Fig.	øD1	øD2	L	L1	L2	W	G	Weight (lbs.)
C5-FMH22-47-60	1	22mm	1.850	2.36	.71	.20	.394	M10	1.3
-90				3.54					3.1
-FMH22-60-60		22mm	2.362	2.36	.71	.20	.394	M10	2.4
-FMH27-60-60		27mm	2.362	2.36	.79	.24	.472	M12	2.4
-FMA25.4-40		25.4mm	1.969	1.57	.87	.20	.375	M12	2.0
-75				2.95					2.6
C6-SMC.750-2	1	.750	1.689	2.00	.69	.16	.313	3/8"-24	3.0
-SMC1.000-2		1.000	2.189	2.00	.69	.22	.375	1/2"-20	4.5
-SMC1.250-2		1.250	2.750	2.00	.69	.28	.500	5/8"-18	4.8
-SMC1.500-2		1.500	3.626	2.00	.94	.38	.625	3/4"-16	5.0
-FMH22-47-45		22mm	1.850	1.77	.71	.20	.394	M10	3.1
-60				2.36					3.5
-90				3.54					4.4
-150				5.91					6.2
-FMH22-60-45		22mm	2.362	1.77	.71	.20	.394	M10	3.5
-60				2.36					4.4
-90				3.54					5.7
-FMH27-60-45		27mm	2.362	1.77	.79	.24	.472	M12	3.7
-60				2.36					4.4
-90				3.54					6.0
-150				5.91					8.6
-FMA25.4-40		25.4mm	1.969	1.57	.87	.20	.375	M12	3.1
-60				2.36					4.0
-90				3.54					5.3
-FMA31.75-40		31.75mm	2.362	1.57	1.18	.28	.500	M16	3.5
-90				3.54					5.7
-FMA38.1-45		38.1mm	3.150	1.77	1.34	.35	.625	M20	4.8
-FMC16-40		16mm	1.260	1.57	.63	.20	.315	M8	2.9
-FMC22-40		22mm	1.772	1.57	.71	.20	.394	M10	3.1

Catalog Number	Fig.	øD1	øD2	L	L1	L2	W	G	Weight (lbs.)	
C8-FMH22-47-60	1	22mm	1.850	2.36	.71	.20	.394	M10	6.2	
-105				4.13					7.5	
-150				5.91					8.8	
-200				7.87					10.4	
-FMH22-60-60		22mm	2.362	2.36	.71	.20	.394	M10	6.8	
-105				4.13					8.8	
-150				5.91					11.0	
-FMH27-60-60		27mm	2.362	2.36	.79	.24	.472	M12	6.8	
-105				4.13					9.0	
-150				5.91					11.0	
-200				7.87					13.4	
-FMH32-96-75		32mm	3.780	2.95	.87	.28	.551	M16	10.1	
-105				4.13					15.0	
-150				5.91					16.5	
-FMA25.4-40		2	25.4mm	1.969	1.57	.87	.20	.374	M12	6.0
-75					2.95					7.1
-105	4.13				8.4					
-FMA31.75-40	31.75mm		2.362	1.57	1.18	.28	.500	M16	6.0	
-90				3.54					8.8	
-FMA38.1-45	38.1mm		3.150	1.77	1.34	.35	.625	M20	7.1	

• Locking Screw is included, clamp bolt must be ordered separately

ACCESSORIES



CAUTION

For high speed applications, Shell Mill Holders should be balanced together with the cutters.

MEGA SYNCHRO TAPPING HOLDER

TAPPING RANGE: No.2-AU3/4 (M2-M20)

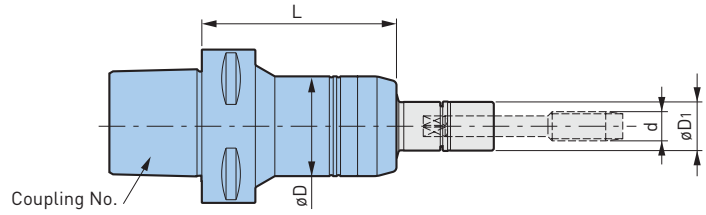
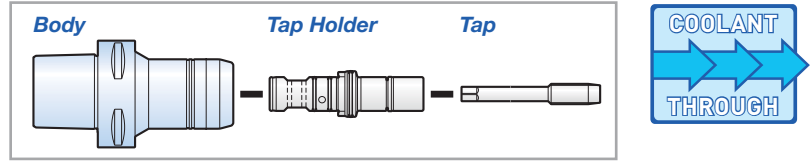

Catalog Number	Tapping Range d* (Inch)	Tapping Range d* (Metric)	øD	øD1	L	Wrench	Weight (lbs.)
C5-MGT6-75	No.2-No.12	M2-M6	1.42	.63	2.95	MGR16	1.8
-MGT12-75	AU1/4-AU7/16	M6-M12	1.61	.79	2.95	MGR20L	2.0
-MGT20-100	AU1/2-AU3/4 AP1/8-AP1/4	M12-M20	2.13	1.18	3.94	MGR30L	3.1
C6-MGT6-80	No.2-No.12	M2-M6	1.42	.63	3.15	MGR16	2.4
-MGT12-80	AU1/4-AU7/16	M6-M12	1.61	.79	3.15	MGR20L	2.6
-MGT20-100	AU1/2-AU3/4 AP1/8-AP1/4	M12-M20	2.13	1.18	3.94	MGR30L	4.0
C8-MGT6-80	No.2-No.12	M2-M6	1.42	.63	3.15	MGR16	4.6
-MGT12-80	AU1/4-AU7/16	M6-M12	1.61	.79	3.15	MGR20L	4.8
-MGT20-95	AU1/2-AU3/4 AP1/8-AP1/4	M12-M20	2.13	1.18	3.74	MGR30L	5.7

*AU3/8 is included in the MGT20 series

- Tap holder and wrench must be ordered separately

ACCESSORIES



CAUTION

Cannot be used with machining center without synchronized tapping function.

CKB SHANK

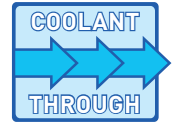
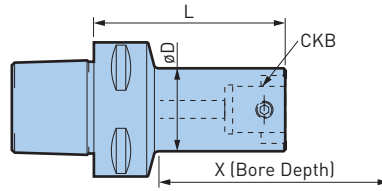

Catalog Number	CK	øD	L	X	Weight (lbs.)
C4-CKB1-48	CKB1	.748	1.870	2.165	.9
-CKB2-45	CKB2	.945	1.752	2.165	.9
-CKB3-40	CKB3	1.220	1.575	2.244	1.1
-CKB4-33	CKB4	1.535	1.299	2.441	1.1
C5-CKB1-73	CKB1	.748	2.854	3.150	1.1
-CKB2-85	CKB2	.945	3.327	3.780	1.3
-CKB3-55	CKB3	1.220	2.165	2.750	1.3
-CKB4-48	CKB4	1.535	1.870	2.750	1.3
-CKB5-50	CKB5	1.969	1.968	3.150	1.3
-CKB6-50	CKB6	2.520	1.968	3.930	2.2
C6-CKB1-78	CKB1	.748	3.051	3.268	2.6
-CKB2-90	CKB2	.945	3.524	3.858	2.9
-CKB3-65	CKB3	1.220	2.559	3.150	2.9
-100			3.937	4.449	3.3
-CKB4-58	CKB4	1.535	2.283	3.150	2.9
-93			3.661	4.449	3.7
-CKB5-48	CKB5	1.969	1.890	3.110	2.9
-CKB5-83			3.268	4.488	3.7
-CKB6-59	CKB6	2.520	2.323	5.000	3.5
-94			3.701	6.400	5.1
C8-CKB4-118	CKB4	1.535	4.646	5.118	5.3
-178			7.008	7.480	6.6
-CKB5-108	CKB5	1.969	4.252	5.118	5.9
-183			7.205	8.071	8.4
-CKB6-74	CKB6	2.520	2.913	4.331	5.5
-169			6.654	8.110	10.6
-CKB7-73	CKB7	3.543	2.874	7.480	6.8
-123			4.843	9.400	12.3

- X dimensions on the table are reference figures when EWN/EWE head is mounted
- Center through coolant supply is available

Integral Versions Available



EWN 2-50XL Finish Boring Head

Boring Range: ø.78"-2.125"

Compact, statically balanced design permits high cutting speeds, minimal projection and optimal performance.



EWN Finish Boring Head

Boring Range: ø1.260"-8.000"

Multifunctional and balance optimized for highest efficiency.

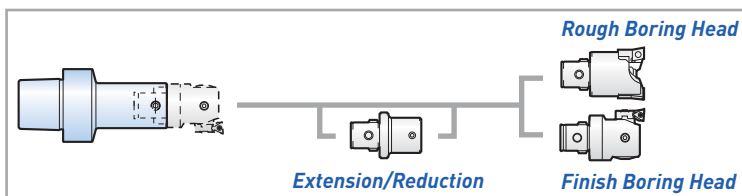

BIG KOMET ABS SHANK

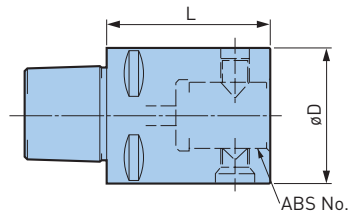
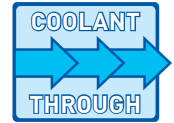

Catalog Number	ABS No.	øD	L	Weight (lbs.)
C5-ABS50-50	50	1.969	1.969	.3
C6-ABS50-50	50	1.969	1.969	.6
-ABS63-60	63	2.480	2.362	.8
C8-ABS50-50	50	1.969	1.969	1.2
-ABS63-60	63	2.480	2.362	1.3
-ABS80-80	80	3.150	3.150	1.7

BIG CAPTO A.4



DYNA TEST

Helps identify potential problems, and can reduce downtime and costly repairs of the machine tool spindle.

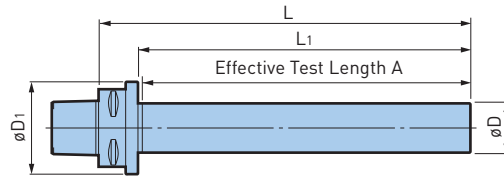
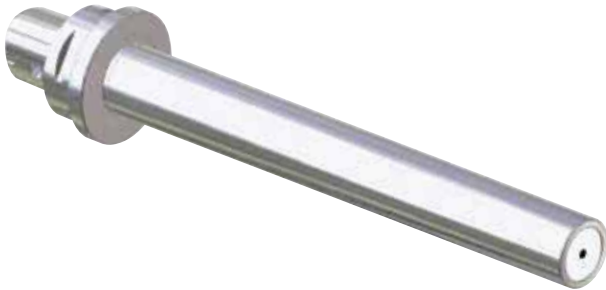

Catalog Number	L	L1	A	øD	øD1
C5-32-150	7.087	5.906	5.827	32mm	63mm
-215	9.646	8.465	8.386		
-40-L50	11.024	9.843	9.724		
C6-40-L150	7.165	5.906	5.787	40mm	75mm
-L200	9.134	7.874	7.756		
-L320	13.858	12.598	12.480		
C8-40-L200	9.449	7.874	7.756	40mm	85mm
-L320	14.173	12.598	12.480		



A.4
BIG CAPTO

SPINDLE CLEANERS

The unbeatable tool to ensure absolute cleanliness of tapered spindles, which maintains the precision and prolongs the life of your expensive machine tools, cutting tools and tool holders.

- Robust construction with high oil and grease resistance
- Plastic injection molded core with fluted locations for cleaning strips ensures accurate sizing and cleaning efficiency
- Cleaning strips will maintain adhesion to the taper core due to inset location even under scrubbing action
- Cleaning strips positioned at well spaced intervals to remove even large residual particles
- A quality control product

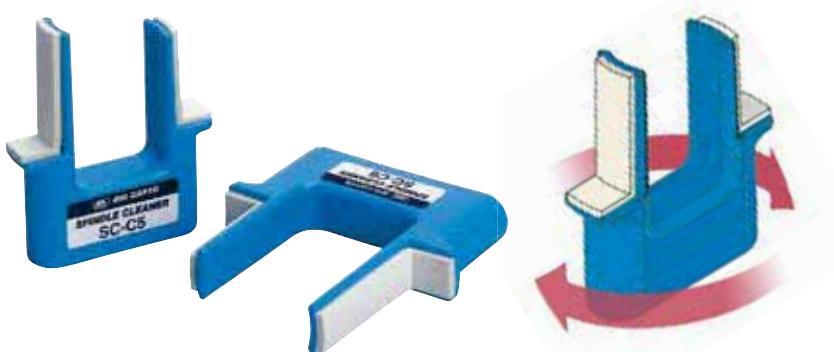

Catalog Number	Description	Taper No.
SC-C3	Polygon Taper C3 Spindle Cleaner	C3
SC-C4	Polygon Taper C4 Spindle Cleaner	C4
SC-C5	Polygon Taper C5 Spindle Cleaner	C5
SC-C6	Polygon Taper C6 Spindle Cleaner	C6
SC-C8	Polygon Taper C8 Spindle Cleaner	C8

MODULAR TOOL HOLDERS

CK/CKB/CKN SHANK

A.5

CK/CKB/CKN A.5



BASIC ARBORS	262-264
EXTENSIONS & REDUCTIONS	262-264
COLLET CHUCKS	265
MEGA ER GRIP	265
TG STYLE ANGLE	265
MILLING CHUCKS	266
NEW Hi-POWER MILLING CHUCK	266
TAP HOLDERS	267
MEGA SYNCHRO TAPPING HOLDER	267
ADAPTERS	268-271
TAPPING ADAPTER	268
END MILL ADAPTER	269-270
UNIVERSAL DRILL CHUCKS ADAPTER	271
SHELL MILL TOOL ADAPTER	271
GROOVE MILLING ADAPTER	272
ACCESSORIES	273
BLANK BAR	273

EXTENSIONS

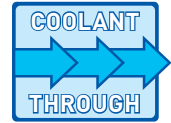
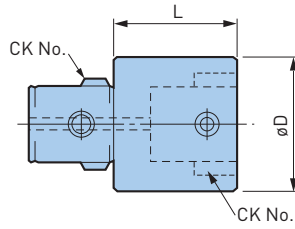

Catalog Number	Reference Number	CK	øD	L	Weight (lbs.)
CKB1-CKB1-20	10.331.110	CKB1	.748	.787	.1
-30	10.331.111			1.181	.2
CKB2-CKB2-30	11.331.220	CKB2	.945	1.181	.2
-45	11.331.221			1.772	.3
CKB3-CKB3-30	11.331.330	CKB3	1.220	1.181	.4
-45	11.331.331			1.772	.5
CKB4-CKB4-40	11.331.440	CKB4	1.535	1.575	.8
-60	11.331.441			2.362	1.0
CKB5-CKB5-60	11.331.550	CKB5	1.968	2.362	1.9
-90	11.331.551			3.543	2.7
CKB6-CKB6-60	11.331.660	CKB6	2.491	2.362	3.0
-100	11.331.661			3.937	4.4
CKB7-CKB7-100	11.331.770	CKB7	3.543	3.937	9.7
-160	11.331.771			6.299	16.0

- Center through coolant supply is available
- Using an extension to increase length may cause chatter depending on the L/D ratio

ACCESSORIES



CK/CKB/CKN A.5

SMART DAMPER EXTENSIONS

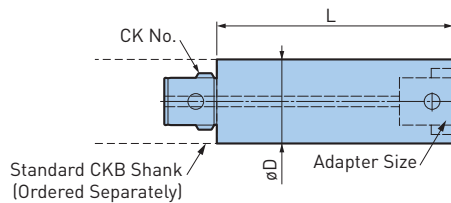
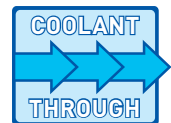
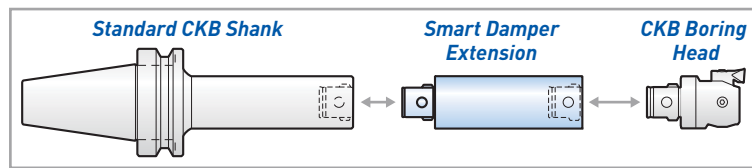

Catalog Number	CK	øD	L	Weight (lbs.)
CKB44DP-120	CKB4	1.535	4.724	2.9
CKB55DP-150	CKB5	1.968	5.906	5.7
CKB66DP-180	CKB6	2.520	7.087	12.3

- Center through coolant supply is available
- Should not be used with a conventional extension due to possible chatter

CAUTION ⚠

Damping function may become less effective over time due to the break-down of special elastomers used in the damping mechanism. If excessive vibration occurs after 1 year of continued use, it is recommended to return SMART DAMPER bars for overhaul. Please contact BIG KAISER for details of repair.

REDUCTIONS

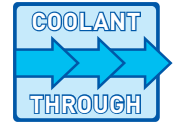
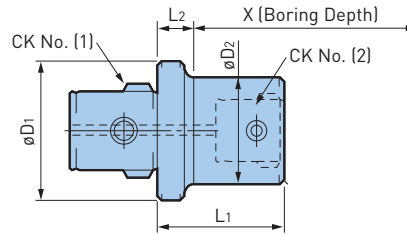

Catalog Number	Reference Number	CK (1)	ϕD_1	CK (2)	ϕD_2	L1	L2	X	Weight (lbs.)
CKB2-CKB1-36	10.332.210	CKB2	.945	CKB1	.748	1.417	.413	2.165	.2
CKB3-CKB1-41	10.332.310	CKB3	1.220	CKB1	.748	1.594	.394	2.362	.3
-CKB2-35	10.332.320			CKB2	.945	1.358			.4
CKB4-CKB1-58	10.332.410	CKB4	1.535	CKB1	.748	2.264	.472	2.953	.5
-CKB2-52	10.332.420			CKB2	.945	2.028			.6
-CKB3-47	10.332.430			CKB3	1.220	1.850			.7
CKB5-CKB1-58	10.332.511	CKB5	1.968	CKB1	.748	2.264	.669	2.756	1.0
-88	10.332.510					3.445			1.0
-CKB2-52	11.332.521					2.028			.9
-82	11.332.520			3.209	1.2				
-CKB3-47	10.332.531			CKB3	1.220	1.850			1.0
-77	10.332.530					3.031			1.5
-CKB4-40	11.332.541					CKB4			1.535
-70	11.332.540			2.756	1.6				
CKB6-CKB1-67	10.332.611			CKB6	2.500	CKB1			.748
-102	11.332.610	3.996	2.0						
-CKB2-61	11.332.621	CKB2	.945				2.382	1.5	
-96	11.332.620					3.760	1.8		
-CKB3-56	11.332.631	CKB3	1.220			2.205	1.7		
-91	11.332.630					3.583	2.1		
-136	11.332.632					5.354	2.6		
-CKB4-49	11.332.641	CKB4	1.535			1.929	1.8		
-84	11.332.640					3.307	2.3		
-129	11.332.642					5.079	3.2		
-CKB5-39	11.332.651					CKB5	1.968	1.535	1.9
-74	11.332.650	2.913	2.7						
-119	11.332.652	4.685	4.3						
CKB7-CKB4-70	10.332.741	CKB7	3.543	CKB4	1.535	2.756	.669	3.937	3.3
-CKB5-60	10.332.751					CKB5			1.969
-120	10.332.750			4.724	5.3				
-CKB6-76	11.332.761			CKB6	2.520				
-106	11.332.760					4.173			6.6

- X dimensions on the table are reference figures when EWN/EWE head is mounted
- Center through coolant supply is available

ACCESSORIES

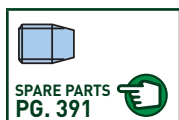

DOUBLE CONNECTOR COUPLINGS



Catalog Number	Reference Number	Size 1/2	øD	L	Weight (lbs.)
DC-CKN6-CKN6-0	10.331.864N	CKN6	—	0	1.0
DC-CKN7-CKN7-0	10.331.874N	CKN7	—	0	2.1

*The additionally needed 2 pcs of CK-screws are included in the delivery of the mating KCN component with male connector

DOUBLE CONNECTOR COUPLINGS

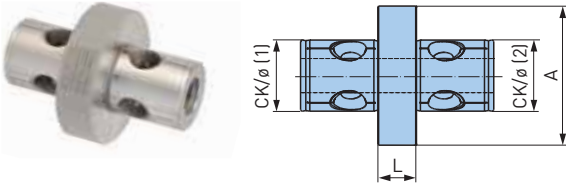

Catalog Number	Reference Number	CK	øD	L	Weight (lbs.)
DC-CKN6-CKN6-20	10.331.865N	CKN6	2.500	.787	2.1
DC-CKN7-CKN7-25	10.331.875N	CKN7	3.543	.984	4.4
-50	10.331.876N			1.969	6.8

*The additionally needed 2 pcs of CK-screws are included in the delivery of the mating KCN component with male connector

DOUBLE CONNECTOR REDUCTION

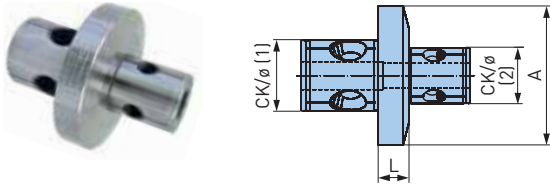

Catalog Number	Reference Number	CK (1)	CK (2)	øD	L	Weight (lbs.)
DC-CKN7-CKN6-20	10.332.875N	CKN7	CKN6	3.543	0.787	3.7

*The additionally needed 2 pcs of CK-screws are included in the delivery of the mating KCN component with male connector

REDUCTION ALUMINIUM

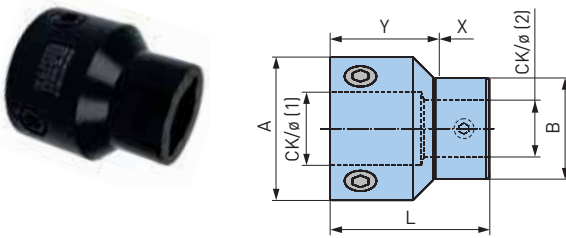

Catalog Number	Reference Number	CK (1)	CK (2)	øD1	øD2	L	Weight (lbs.)
CKN7-CKB6-100	10.332.870N	CKN7	CKB6	3.937	2.500	3.937	2.4

*The additionally needed 2 pcs of CK-screws are included in the delivery of the mating KCN component with male connector

EXTENSION TUBES ALUMINIUM

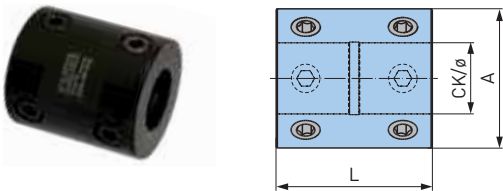

Catalog Number	Reference Number	CK	ød	L	Weight (lbs.)
T-CKN6-CKN6-80	10.331.867N	CKN6	2.500	3.150	1.1
-120	10.331.868N			4.724	1.8
T-CKN7-CKN7-100	10.331.877N	CKN7	3.543	3.937	3.4
-150	10.331.879N			5.905	5.0
-200	10.331.878N			7.874	6.6

ADAPTER TUBES ALUMINIUM

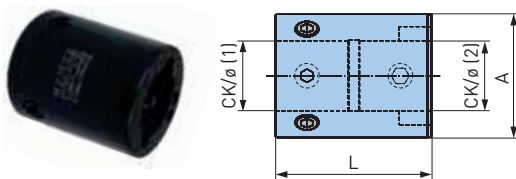

Catalog Number	Reference Number	CK (1)	CK (2)	øD	L	Weight (lbs.)
T-CKN6-CKB6-80	10.331.860N	CKN6	CKB6	2.500	3.150	1.2
-120	10.331.861N				4.724	1.8
T-CKN7-CKB7-100	10.331.870N	CKN7	CKB7	3.543	3.937	3.1
-150	10.331.871N				5.905	4.8

MEGA ER GRIP

CLAMPING RANGE: ϕ .075"-.787" (ϕ 1.9-20mm) For Drills, Reamers, Taps & Finishing End Mills

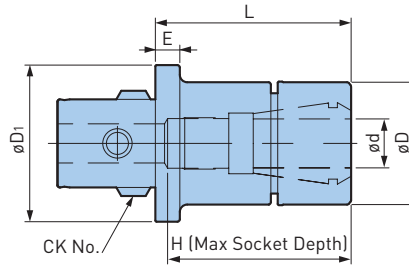
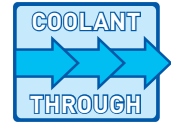

Catalog Number	CK	ϕd	ϕD	ϕD_1	L	Weight (lbs.)
CKB4-MEGAER16-60NL	CKB4	.075-.394	1.181	1.535	2.362	1.7
-MEGAER20-70NL		.108-.512	1.378		2.756	2.2
CKB5-MEGAER25-80NL	CKB5	.108-.630	1.654	1.969	3.150	3.8
-MEGAER32-80NL		.108-.787	1.969		3.150	4.7
CKB6-MEGAER32-80NL	CKB6	.108-.787	1.969	2.520	3.150	5.8

- *Nut, adjusting screw, balance screws, collet and wrench are not included
- "H" indicates the adjustment length with an adjusting screw
- MEGA ER GRIP is not able to use DIN6499 Form-A collets and ESX collets
- Weight does not include collet

ACCESSORIES



*MEGA NUT is the recommended nut to achieve high accuracy and clamping force

TG STYLE ANGLE

CLAMPING RANGE: ϕ .062"-1.500" For Drills, Reamers, Taps & Finishing End Mills

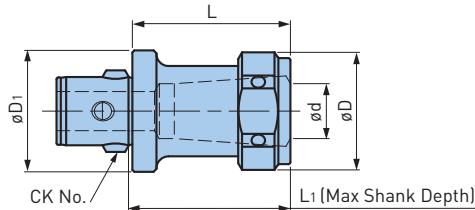

Catalog Number	Reference Number	CK	ϕd	ϕD	ϕD_1	L	L ₁	Collet Nuts
CKB6-TG75-71	11.335.106	CKB6	.062-.750	2.10	2.520	2.78	2.20	11.335.185
-TG100-83	11.335.107		.093-1.000	2.50		3.28	2.72	11.335.186
-TG150-96	11.335.108		.500-1.500	3.50		3.78	3.30	11.335.187

- Wrench and collet must be ordered separately
- BIG KAISER does not offer TG collets

NEW Hi-POWER MILLING CHUCK

CLAMPING RANGE: ϕ .750"-1.250" (ϕ 20-32mm)

For Heavy Duty End Milling

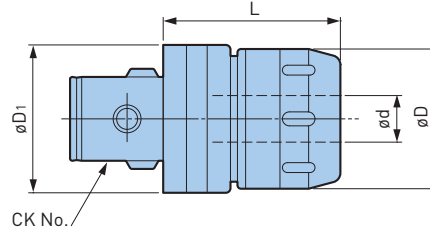
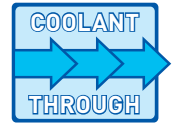

Catalog Number	Reference Number	CK	ϕd	ϕD	$\phi D1$	L	Weight (lbs.)
CKB6-HMC.750	11.335.067	CKB6	.750	2.36	2.520	2.95	4.7
-HMC20 ❖	10.335.066		20mm				4.4
CKB7-HMC1.250	11.335.078	CKB7	1.25	3.15	3.543	4.13	9.2
-HMC32	10.335.077		32mm				10.5

- Wrench included
- Use OCA, C straight collets with models marked ❖

ACCESSORIES

 COLLET PG. 364	 PERFECT SEAL/ JET COLLET PG. 361	 WRENCH PG. 367
---	--	---



MEGA SYNCHRO TAPPING HOLDER

TAPPING RANGE: No.6-AU3/4 (M2-M20)

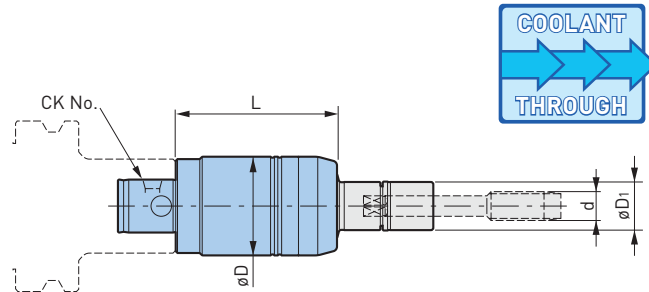
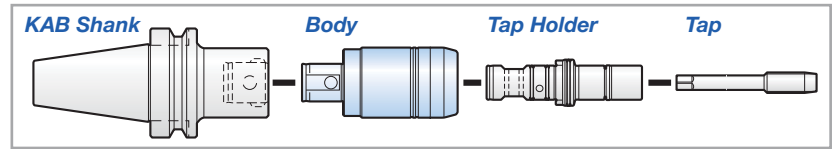

Catalog Number	CK	Tapping Range d* (Inch)	Tapping Range d* (Metric)	øD	øD1	L	Wrench	Weight (lbs.)
CKB4-MGT6-62	CKB4	No.2-No.12	M2-M6	1.417	.629	2.441	MGR16	1.1
-MGT12-67		AU1/4-AU7/16*	M6-M12	1.614	.787	2.638	MGR20L	1.3
CKB5-MGT20-87	CKB5	AU1/2-AU3/4, AP1/8-AP1/4	M12-M20	2.126	1.181	3.425	MGR30L	2.6

*AU3/8 is included in the MGT20 series
 • Tap holder and wrench must be ordered separately

CAUTION
 Cannot be used with machining center without synchronized tapping function.

TAPPING RANGE: AU13/16-AU1-3/8 (M20-M36)

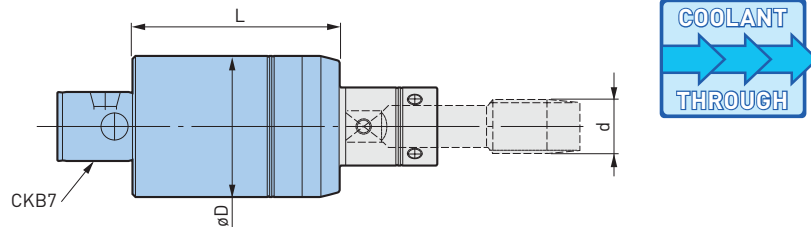

Catalog Number	CK	Tapping Range d (Inch)	Tapping Range d (Metric)	øD	L	Weight (lbs.)
CKB7-MGT36-137	CKB7	AU13/16-AU1-3/8 AP3/8-AP1	M20-M36	3.701	5.394	15.0

• MGT Set Screw and adjust screw are included, tap holder must be ordered separately

CAUTION
 Cannot be used with machining center without synchronized tapping function.

ACCESSORIES

TAP HOLDER PG. 374	MEGA NUT PG. 381	SYNCHRO ADJUSTER PG. 381	O-RING PG. 381	MEGA WRENCH PG. 368	SCREW PG. 381
-----------------------	---------------------	-----------------------------	-------------------	------------------------	------------------

A.5 CK/CKB/CKN

For Tension & Compression Tapping Chuck. Heavy-duty tapping attachments for high production thread cutting on machine tools and machining centers.

- Extremely short, rigid design
- Large-length compensation in response to tension and compression
- Quick-change clutch for tap holders with or without torque control
- Bilz and Tapmatic compatible

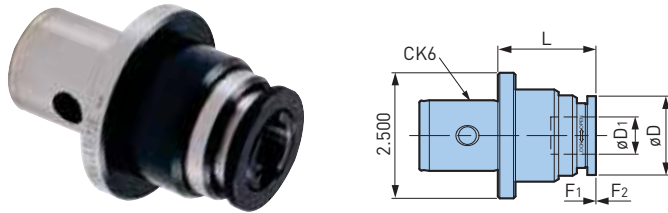

Catalog Number	Reference Number	Tapping Range	Tap Adapter Size*	øD	øD1	L	F1	F2	Weight (lbs.)
CK6-ATE12E	10.335.762	0-9/16	1	1.850	.748	1.969	.197	.394	1.9
-ATE24E	10.335.763	5/16-7/8	2	2.520	1.220	3.150	.275	.551	3.4

*Tap collets with torque control or positive drive available upon request

For Rigid Tapping

- Extremely short and compact tapping chuck without axial float
- For tapping on machine tools with speed and feed synchronization
- For quick-change tap holders with or without torque clutch
- Bilz and Tapmatic compatible

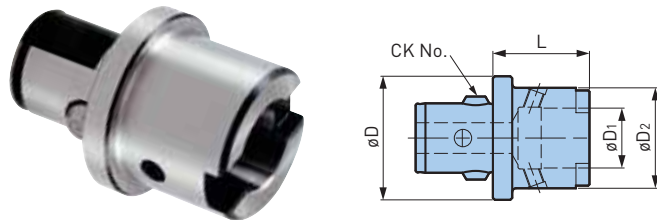

Catalog Number	Reference Number	CK	øD	Tapping Range	Tap Adapter Size*	øD1	øD2	L	Weight (lbs.)
CKB5-RTE12-30	11.335.760	CKB5	1.968	0-9/16	1	.748	1.535	1.181	.9
CKB6-RTE24-52	11.335.765	CKB6	2.500	5/16-7/8	2	1.220	2.047	1.968	2.1
-RTE36-70	11.335.769			13/16-1-3/8	3	1.890	2.756	2.756	3.3

*Tap collets with torque control or positive drive available upon request

CK/CKB/CKN A.5

For End Mills

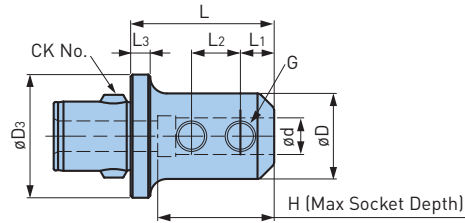

Catalog Number	Reference Number	CK	ød	øD	øD3	L	L1	L2	L3	H	G	Weight (lbs.)
CKB4-SL.187-33	11.335.220	CKB4	.1875	.68	1.535	1.283	.44	—	.4	—	1/4"-28	.7
-SL.250-33	11.335.221		.2500	.88		1.283	.44	—	.4	—	1/4"-28	.6
-SL.375-45	11.335.222		.3750	1.00		1.784	.75	—	.4	—	3/8"-24	.8
-SL.500-48	11.335.223		.5000	1.25		1.904	.88	—	.4	1.70	7/16"-20	.8
CKB5-SL.187-33	11.335.226	CKB5	.1875	.68	1.969	1.283	.44	—	.4	—	1/4"-28	.9
-SL.250-33	11.335.227		.2500	.88		1.283	.44	—	.4	—	1/4"-28	1
-SL.375-45	11.335.228		.3750	1.00		1.784	.75	—	.4	—	3/8"-24	1.2
-SL.500-48	11.335.229		.5000	1.25		1.904	.88	—	.4	1.79	7/16"-20	1.1
-SL.750-77	11.335.231		.7500	1.75		3.031	.94	—	.4	2.75	9/16"-18	2
CKB6-SL.187-33	11.335.201	CKB6	.1875	.68	2.500	1.283	.44	—	.4	—	1/4"-28	1.5
-SL.250-33	11.335.202		.2500	.88		1.283	.44	—	.4	—	1/4"-28	1.4
-SL.375-45	11.335.203		.3750	1.00		1.784	.75	—	.4	—	3/8"-24	1.5
-SL.500-48	11.335.204		.5000	1.25		1.904	.88	—	.4	—	7/16"-20	1.7
-SL.625-77	11.335.205		.6250	1.50		3.031	.94	—	.4	—	9/16"-18	2.3
-SL.750-77	11.335.206		.7500	1.75		3.031	1.00	—	.4	2.75	5/8"-18	2.6
-SL.875-77	11.335.207		.8750	1.88		3.031	1.00	.81	.4	2.75	5/8"-18	2.8
-SL1.00-83	11.335.208		1.0000	2.00		3.280	1.12	1.00	.4	2.88	3/4"-16	3.1
-SL1.25-83	11.335.209		1.2500	2.49		3.280	1.12	1.00	—	3.00	3/4"-16	4.4
CKB7-SL1.25-83	11.335.216	CKB7	1.2500	2.50	3.543	3.250	1.12	1.00	.5	3.00	3/4"-16	5.4
-SL1.50-83	11.335.217		1.5000	2.62		3.250	1.12	1.00	.5	2.83	3/4"-16	5.3
-SL2.00-124	11.335.218		2.0000	3.75		4.880	1.41	1.50	—	3.75	1"-12	12.3

A.5 CK/CKB/CKN

For End Mills

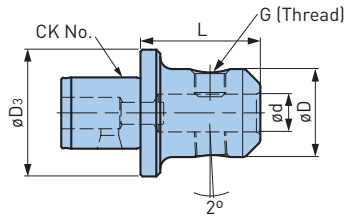

CK/CKB/CKN A.5

Catalog Number	Reference Number	CK	ød	øD	øD3	L	G	Weight (lbs.)
CK4-SL6-50	10.335.230	CK4	6mm	24mm	39mm	50mm	M6	.6
-SL8-50	10.335.231		8mm	26mm		50mm	M8	2.0
-SL10-55	10.335.232		10mm	32mm		55mm	M10	.9
-SL12-60	10.335.233		12mm	39mm		60mm	M12	1.2
CK5-SL6-50	10.335.234	CK5	6mm	24mm	50mm	50mm	M6	.9
-SL8-50	10.335.235		8mm	26mm		50mm	M8	.9
-SL10-55	10.335.236		10mm	32mm		55mm	M10	1.2
-SL12-60	10.335.237		12mm	38mm		60mm	M12	1.5
-SL14-60	10.335.238		14mm	40mm		60mm	M12	1.5
-SL16-62	10.335.239		16mm	45mm		62mm	M14	1.7
CK6-SL6-45	10.335.240	CK6	6mm	24mm	63.5mm	45mm	M6	1.3
-SL8-45	10.335.241		8mm	26mm		45mm	M8	1.4
-SL10-45	10.335.242		10mm	26mm		45mm	M10	1.5
-SL12-50	10.335.243		12mm	26mm		50mm	M12	1.8
-SL14-50	10.335.244		14mm	26mm		50mm	M12	1.9
-SL16-50	10.335.245		16mm	26mm		50mm	M14	2.0
-SL18-50	10.335.246		18mm	26mm		50mm	M14	2.0
-SL20-55	10.335.247		20mm	26mm		55mm	M16	2.3
-SL25-65	10.335.248		25mm	26mm		65mm	M18	3.7
CK7-SL32-80	10.335.250	CK7	32mm	26mm	90mm	80mm	M20	6.4
-SL40-90	10.335.251		40mm	26mm		90mm	M20	7.5

***Weldon System only**

- Metric size end mill adapters according to both DIN 1835B (Weldon System) and DIN 1835E (Whistle Notch System)

For Universal Drill Chucks

With strong clamping force and high run out accuracy. Quick and simple clamping over a bevel gear.

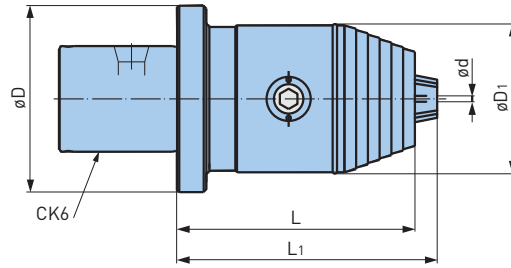

Catalog Number	Reference Number	CK	ød	øD	øD1	L	L1	Weight (lbs.)
CK6-DC13-90	10.335.042	CK6	.040-.512	2.5	1.969	3.189	3.543	3.0
-DC16-92	10.335.044		.118-.630		2.244	3.386	3.622	3.3

A.5
CK/CKB/CKN

For Shell Mills

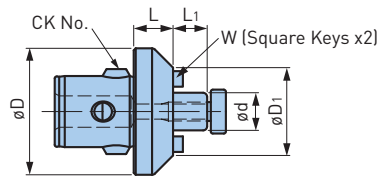

Catalog Number	Reference Number	CK	ød	øD	øD1	L	L1	W	Clamping Screw
CKB4-SM.500-18	11.335.445	CKB4	.500	1.535	1.535	.708	.56	.25	11.690.709
-SM.750-18	11.335.446		.750	—	1.752	.708	.68	.31	11.690.710
CKB5-SM.500-20	11.335.454	CKB5	.500	1.969	1.437	.787	.56	.25	11.690.709
-SM.750-20	11.335.455		.750		1.969	.787	.68	.31	11.690.710
-SM1.00-20	11.335.456		1.00		—	2.250	.787	.68	.38
CKB6-SM.500-20	11.335.401	CKB6	.500	2.520	1.437	.787	.56	.25	11.690.709
-SM.750-20	11.335.402		.750		1.752	.787	.68	.31	11.690.710
-SM1.00-20	11.335.403		1.00		2.250	.787	.68	.38	11.690.711
-SM1.250-26	11.335.404		1.25		2.750	1.024	.68	.50	11.690.712
-SM1.500-39	11.335.405		1.50		—	3.750	1.535	.93	.62
CKB7-SM1.00-25	11.335.413	CKB7	1.00	3.54	2.250	.984	.68	.38	11.690.711
-SM1.25-25	11.335.414		1.25		2.750	.984	.68	.50	11.690.712
-SM1.50-25	11.335.415		1.50	—	3.750	.984	.93	.62	11.690.713
-SM2.00-25	11.335.416		2.00	—	4.882	.984	.93	.75	11.690.714

For Groove Milling

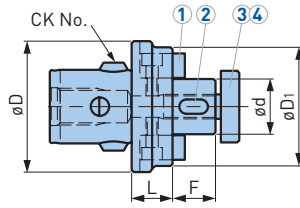

Type				
	Drive Key (1)	Slotting Key (2)	Mounting Screw (3)	Hex Wrench (4)
16	10.691.605	10.691.600	10.690.703	10.690.805
27	10.690.607	10.691.602	10.690.705	10.690.807

Catalog Number	Reference Number	CK	ød	øD	øD1	L	F	Weight (lbs.)
CKB4-FMH16	10.335.420	CKB4	16mm	1.535	1.456	.709	.669	.6
-FMH22	10.335.421		22mm		1.652		.748	.8
CKB5-FMH16	10.335.423	CKB5	16mm	1.970	1.575	.787	.669	.9
-FMH22	10.335.424		22mm		1.849		.748	1.1
-FMH27	10.335.425		27mm		2.085		.827	1.4
CKB6-FMH16	10.335.430	CKB6	16mm	2.500	1.575	.787	.669	1.5
-FMH22	10.335.431		22mm		1.969		.748	1.7
-FMH27	10.335.432		27mm		2.282		.827	2.0
-FMH32	10.335.433		32mm		2.754	1.102	.945	2.9
-FMH40	10.335.434		40mm		3.147		1.063	3.9
CKB7-FMH32	10.335.435		CKB7		32mm	3.543	3.265	1.102
-FMH40	10.335.436	40mm		3.659	1.063		5.5	

CK/CKB/CKN A.5

BLANK BAR

Hardened & Ground Steel Adapter—Steel Blank Machinable RC28-32

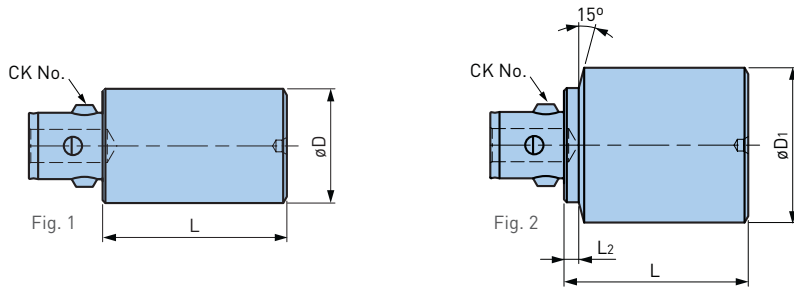

Catalog Number	Reference Number	Fig.	CK	øD	øD1	L	L2	Weight (lbs.)
CKB3-BB31-65	10.335.531	1	CKB3	1.220	1.220	2.560	—	1.0
-BB42-50	10.335.532	2			1.654	1.968	.157	1.3
CKB4-BB39-80	10.335.541	1	CKB4	1.535	1.535	3.150	—	1.3
-BB54-50	10.335.542	2			2.125	1.968	.157	2.1
CKB5-BB50-100	11.335.551	1	CKB5	1.969	1.968	3.937	—	3.8
-BB70-60	10.335.552	2			2.756	2.360	.197	4.1
-BB76-152	11.335.553	2			3.000	6.000	.197	12.0
CKB6-BB64-120	11.335.561	1	CKB6	2.520	2.520	6.000	—	7.1
-BB64-220	11.335.563	1			2.520	8.858	—	13.5
-BB97-70	11.335.562	2			3.820	2.760	.394	8.9
-BB102-203	11.335.564	2			4.000	8.000	.394	28.4
CKB7-BB90-180	11.335.571	1	CKB7	3.543	3.543	7.087	—	21.2

CYLINDRICAL SHANKS

A.6

CYLINDRICAL & N/C LATHE A.6



N/C LATHE TOOLING



CYLINDRICAL SHANKS

COLLET CHUCKS	276-279
MEGA MICRO CHUCK	276-277
NEW BABY CHUCK	278-279
MILLING CHUCKS	280
NEW Hi-POWER MILLING CHUCK	280
HYDRAULIC CHUCKS	281
BASIC ARBORS	282-284
SHRINK FIT HOLDER	282-284
TAP HOLDERS	285
MEGA SYNCHRO TAPPING HOLDER	285
MODULAR HOLDERS	286
CKB SHANK	286
N/C LATHE TOOLING	
COLLET CHUCKS	287-293
MEGA MICRO CHUCK	287
MEGA ER GRIP	288-289
NEW BABY CHUCK	290-293
BASIC ARBORS	294
SMART DAMPER TURNING	294
ACCESSORIES	295-297
CENTERING HOLDER B	295
LATHE MASTER	296
CENTERING TOOL	297

MEGA MICRO CHUCK

CLAMPING RANGE: $\varnothing.018$ "- $.317$ " ($\varnothing.45$ - 8.05 mm)

For Micro Drill & End Mill Applications

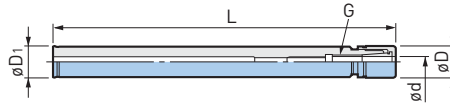
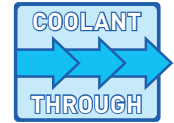

Catalog Number	$\varnothing d$	$\varnothing D$	$\varnothing D_1$	L	G	Collet	Nut	Wrench	Weight (lbs.)
ST.375-MEGA3S-120	.018-.128	.394	.375	4.72	M4 P0.7	NBC3S-□	MGN3S	MGR10	.1
ST.500-MEGA4S-130 -160	.018-.159	.472	.500	5.12	M5 P0.8	NBC4S-□	MGN4S	MGR12	.2
				6.30					.3
ST.625-MEGA6S-160 -200	.018-.238	.551	.625	6.30	M7 P0.75	NBC6S-□	MGN6S	MGR14	.4
				7.87					.5
ST10-MEGA3S-120	.018-.128	.394	10mm	4.72	M4 P0.7	NBC3S-□	MGN3S	MGR10	.1
ST12-MEGA4S-130 -160	.018-.159	.472	12mm	5.12	M5 P0.8	NBC4S-□	MGN4S	MGR12	.2
				6.30					.3
ST14-MEGA6S-160 -200	.018-.238	.551	14mm	6.30	M7 P0.75	NBC6S-□	MGN6S	MGR14	.4
				7.87					.5
ST16-MEGA8S-160 -200	.116-.317	.709	16mm	6.30	M9 P0.75	NBC8S-□	MGN8S	MGR18	.5
				7.87					.6

- MEGA MICRO NUT is included, collet and wrench must be ordered separately
- Weight includes nut but not collet

ACCESSORIES





A.6 CYLINDRICAL & N/C LATHE

NEW BABY

Handles interference issues flexibly when combined with the NEW Hi-POWER MILLING CHUCK.

- Enables easy tool layout for horizontal machining center prone to interference with workpieces and jigs

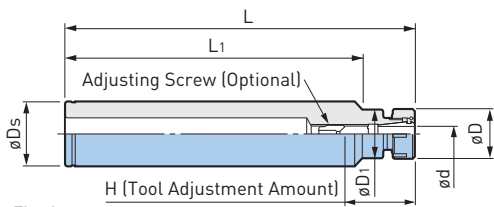
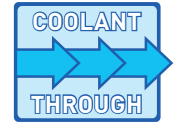

Fig. 1

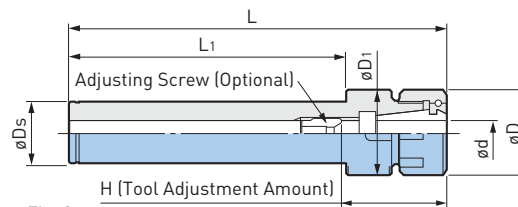

Fig. 2

Catalog Number	Fig.	ød	øD	øD1	øDs	L	L1	H	Collet	Weight (lbs.)
ST20-NBS6-100	1	.010-.236	.787	.768		4.88	3.94	.79-1.57	NBC6-□	.60
-150						6.85	5.91			.86
-250						10.79	9.84			1.41
-NBS8-100	2	.020-.315	.984	.965	.787	4.96	3.94	.91-1.65	NBC8-□	.64
-150						6.93	5.91			.90
-250						10.87	9.84			1.46
-NBS10-100	2	.060-.394	1.181	1.161		5.04	3.94	1.38-1.77	NBC10-□	.71
-150						7.01	5.91			.97
-250						10.94	9.84			1.52
-350						14.88	13.78			2.05
ST25-NBS6-150	1	.010-.236	.787	.768		6.85	5.91	.79-1.57	NBC6-□	1.32
-200						8.82	7.87			1.74
-250						10.79	9.84			2.16
-NBS8-150	2	.020-.315	.984	.965	.984	6.93	5.91	.91-1.65	NBC8-□	1.37
-200						8.90	7.87			1.79
-250						10.87	9.84			2.20
-NBS10-150	2	.060-.394	1.181	1.161		7.01	5.91	1.38-1.77	NBC10-□	1.43
-200						8.98	7.87			1.85
-250						10.94	9.84			2.27
-NBS13-150						2	.098-.512			1.378
-200	9.21	7.87	1.90							
-250	11.18	9.84	2.31							

Catalog Number	Fig.	ød	øD	øD1	øDs	L	L1	H	Collet	Weight (lbs.)
ST32-NBS6-150	1	.010-.236	.787	.768	1.260	6.85	5.91	.79-1.57	NBC6-□	2.12
-200						8.82	7.87			2.82
-NBS8-150		.020-.315	.984	.965		6.93	5.91	.91-1.65	NBC8-□	2.18
-200						8.90	7.87			2.87
-NBS10-150		.060-.394	1.181	1.161		7.01	5.91	1.38-1.77	NBC10-□	2.25
-200						8.98	7.87			2.93
-250						10.94	9.84			3.62
-350						14.88	13.78			4.30
-NBS13-150						.098-.512	1.378			1.358
-200		9.21	7.87	2.98						
-250	11.18	9.84	3.68							
-300	13.15	11.81	5.07							
-NBS16-150	.098-.630	1.654	1.634	7.24	5.91	1.77-2.56	NBC16-□	2.31		
-200				9.21	7.87			3.02		
-300				13.15	11.81			4.41		
-NBS20-150	.098-.787	1.811	1.791	7.24	5.91	1.89-2.56	NBC20-□	2.31		
-200				9.21	7.87			3.02		
-300				13.15	11.81			4.41		

- NEW BABY NUT is included, collet, wrench and adjusting screw must be ordered separately
- Weight includes nut but not the collet
- "H" indicates the adjustment length with an adjusting screw
- ST LOCK is available for mounting and removing tools

CAUTION 

3rd digit in the model number does not correspond to the L dimension (overall length).

ACCESSORIES



NEW Hi-POWER MILLING CHUCK
HMC12J

CLAMPING RANGE: $\varnothing 12\text{mm}$

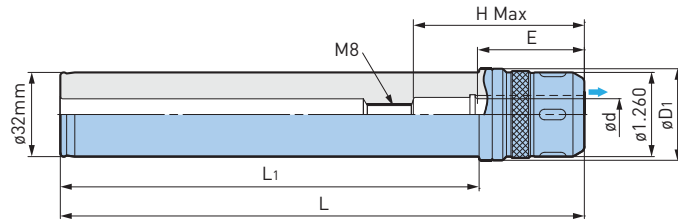
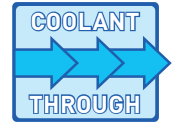
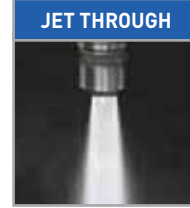
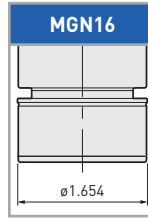
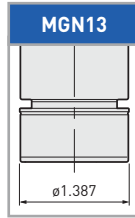
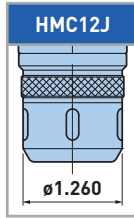

Catalog Number	$\varnothing d$	$\varnothing D1$	L	L1	H Max	Min Clamping Length E	Wrench	Weight (lbs.)
ST32-HMC12J-120	12mm	1.38	4.72	3.15	2.56	1.69	FK31-33	1.5
-160			6.30	4.72				2.0
-200			7.87	6.30				2.4

• Wrench must be ordered separately



CLAMPING RANGE: $\varnothing 4\text{mm}-20\text{mm}$

High Precision Cylindrical Body Eliminates Most Interference Problems

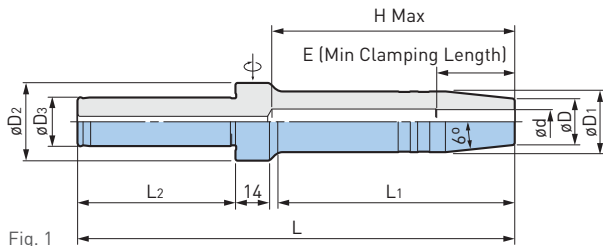
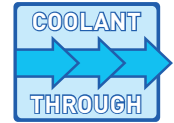

Fig. 1

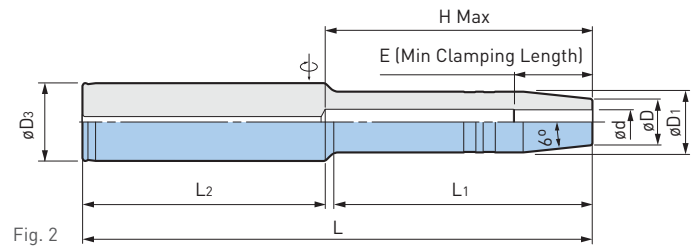

Fig. 2

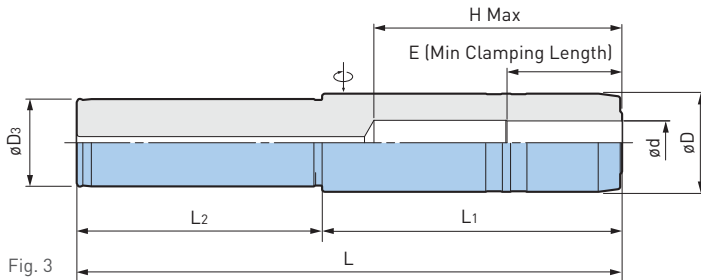

Fig. 3

Catalog Number	Fig.	$\varnothing d$	$\varnothing D$	$\varnothing D1$	$\varnothing D2$	$\varnothing D3$	L	L1	L2	E	H Max	Weight (lbs.)				
ST20-HDC4S-180	1	4mm	.551	.71	1.26	20mm	7.09	3.70	2.56	.75	—	.88				
-HDC6S-180		6mm		.79				3.74		.98	3.98	.95				
-HDC8S-180		8mm	.91	3.78				1.22		3.94	1.10					
-HDC10S-180		10mm	.98	3.82				1.30		3.94	1.19					
-HDC12S-180		12mm	1.10	3.90				1.42		3.94	1.34					
ST32-HDC10S-210	2	10mm	.748	.98	—	32mm	8.27	4.17	3.94	1.30	4.33	2.16				
-HDC12S-210		12mm	.827	1.10				4.25		1.42	4.29	2.33				
-HDC16-200	3	16mm	1.417	—				—		32mm	7.87	4.33	3.54	1.69	3.58	2.79
-HDC20-200		20mm	1.496	—										3.54	3.54	2.82

• Adjusting screw cannot be used

CAUTION

Use only cutting tools that have a shank tolerance of h6 (see table Pg. 26). Do not use with cutting tools made with a flat on the shank (ie: Weldon type shank). Roughing end mills are not recommended for use with HYDRAULIC CHUCKS. Do not tighten the clamping screw without first inserting a cutting tool into the tool holder. Always insert the cutting tool into the hydraulic tool holder beyond min. clamping length "E".

SHRINK CHUCK SUPER SLIM

CLAMPING RANGE: $\phi 4$ -12mm

High Precision Cylindrical Body Eliminates Most Interference Problems

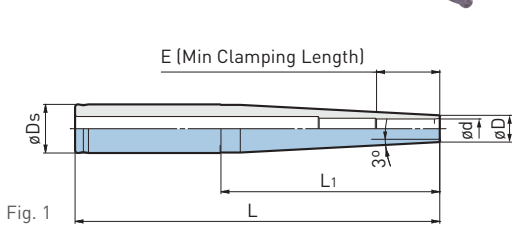
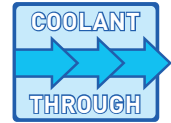

Fig. 1

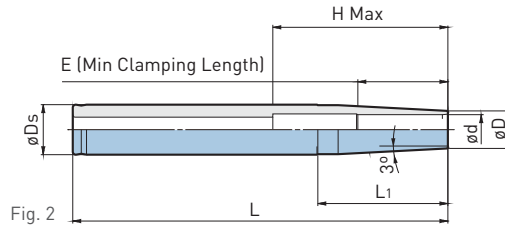

Fig. 2

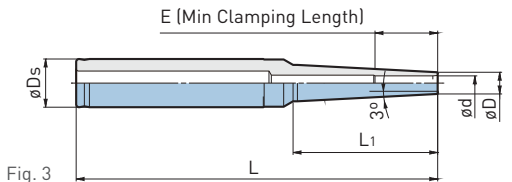

Fig. 3

CYLINDRICAL & N/C LATHE A.6

Catalog Number	Fig.	ϕd	ϕD	ϕd_s	L	L1	H	E	Weight (lbs.)
ST12-SRC4SS-120	1	4mm	.276	.472	4.72	2.01	—	.63	.22
-SRC6SS-120	2	6mm	.354		5.91	1.26	2.05	1.02	.22
ST20-SRC4SS-150-K40	3	4mm	.276	.787	5.91	1.57	—	.63	.55
-SRC6SS-150-K60		6mm	.354	.787	7.87	2.36	—	1.02	.55
-200	1	6mm	.354	.787	9.84	4.33	—	1.02	.66
-250	1								4.33
-SRC8SS-150	1	8mm	.433	.787	5.91	3.54	—	1.02	.55
-200					7.87				.66
-250					9.84				.88
-SRC10SS-150	2	10mm	.512	.787	5.91	2.80	2.36	1.26	.55
-200					7.87				.77
-250					9.84				.88
-SRC12SS-150	2	12mm	.591	.787	5.91	2.05	2.76	1.42	.55
-200					7.87				.77
-250					9.84				.99

- Use a carbide shank cutter within a tolerance of h6
- Center through coolant supply is available with tools with oil holes
- Use a carbide shank cutter within a tolerance of h5 with models marked \diamond

CAUTION

Some shrink fit machines may not be compatible with the Shrink Chuck. Please refer to the shrink fit machine operation manual.

SHRINK CHUCK SLIM

CLAMPING RANGE: $\varnothing 8-20\text{mm}$

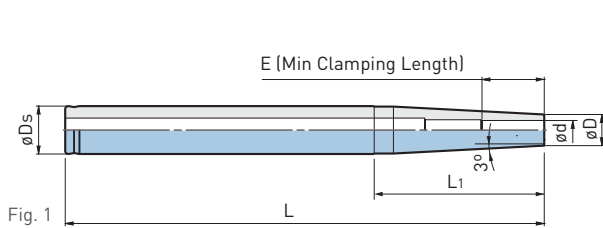
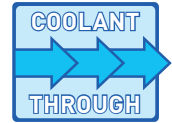

Fig. 1

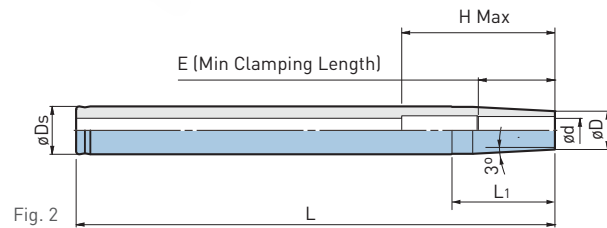

Fig. 2

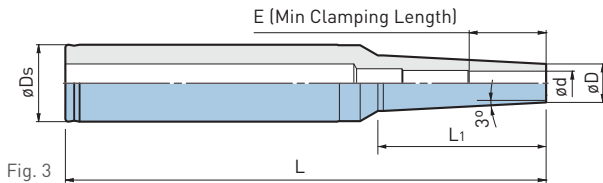

Fig. 3

Catalog Number	Fig.	$\varnothing d$	$\varnothing D$	$\varnothing D_s$	L	L ₁	H	E	Weight (lbs.)
ST32-SRC12S-150-K70	3	12mm	.748	1.260	5.91	2.76	—	1.42	1.2
-200-K70					7.87				1.8
-300-K70					2.76	2.8			
-SRC16S-150	2	16mm	.945	1.260	5.91	3.27	2.76	1.50	1.3
-200					7.87		3.15		1.9
-300					11.81	2.9			
-SRC20S-150	2	20mm	1.102	1.260	5.91	1.97	3.15	1.50	1.3
-200					7.87				1.9
-300					11.81				2.9

- Use a carbide shank cutter within a tolerance of h6
- Center through coolant supply is available with tools with oil holes

CAUTION

Some shrink fit machines may not be compatible with the Shrink Chuck. Please refer to the shrink fit machine operation manual.

SHRINK FIT HOLDER

CLAMPING RANGE: $\varnothing 4$ -16mm

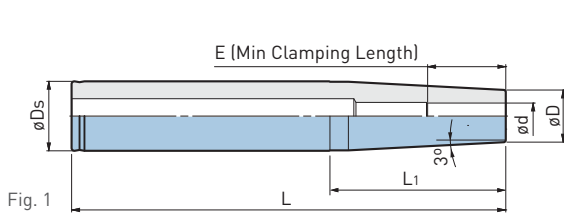
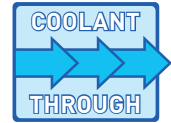

Fig. 1

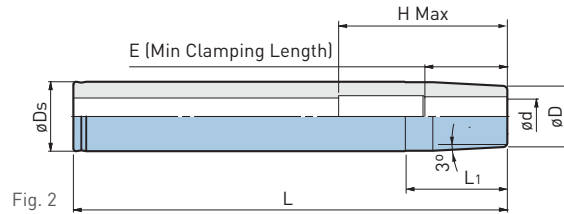

Fig. 2

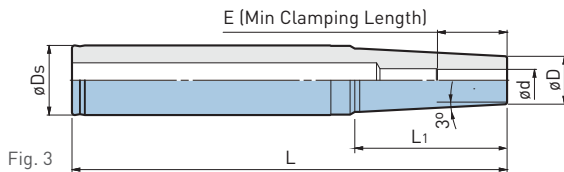

Fig. 3

CYLINDRICAL & N/C LATHE A.6

Catalog Number	Fig.	$\varnothing d$	$\varnothing D$	$\varnothing D_s$	L	L ₁	H	E	Weight (lbs.)
ST20-SRC4-150-K40 ❖	3	4mm	.394	.787	5.91	1.57	—	.63	.6
-150-K80 ❖						3.15			.4
-SRC6-150	1	6mm	.551	.787	5.91	2.44	—	1.02	.7
-200					7.87				.8
-250					9.84				1.0
ST32-SRC10-150-K70	3	10mm	.866	1.260	5.91	2.76	—	1.26	1.4
-200	1				3.94	1.9			
-200-K70	3				2.76	2.0			
-300	1				3.94	2.9			
-300-K70	3				2.76	3.0			
-SRC12-150	1	12mm	.945	1.260	5.91	3.19	—	1.42	1.4
-200					7.87				2.0
-300					11.81				3.0
-SRC16-150	2	16mm	1.102	1.260	5.91	1.85	2.76	1.50	1.5
-200					7.87		3.0		
-300					11.81		3.15		3.0

- Use a carbide shank cutter within a tolerance of h6
- Center through coolant supply is available with tools with oil holes
- Use a carbide shank cutter within a tolerance of h5 with models marked ❖

CAUTION ⚠

Some shrink fit machines may not be compatible with the Shrink Chuck. Please refer to the shrink fit machine operation manual.

MEGA SYNCHRO TAPPING HOLDER

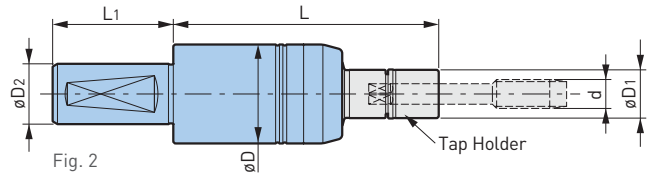
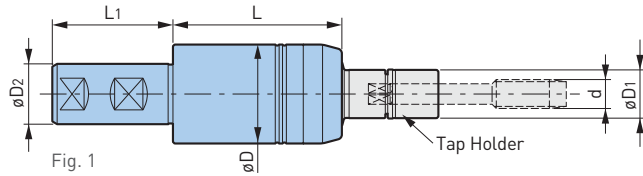
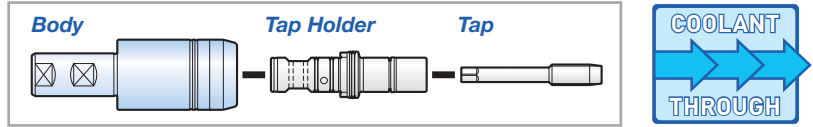

Catalog Number	Fig.	Tapping Range d* (Inch)	Tapping Range d* (Metric)	ϕD	ϕD_1	ϕD_2	L	L ₁	Wrench	Weight (lbs.)
SL1.000-MGT6-2.5	1	No.2-No.12	M2-M6	1.42	.63	1.000	2.50	2.28	MGR16	1.1
-MGT12-2.75		AU1/4-AU7/16 AU1/2-AU3/4	M6-M12	1.61	.79	1.000	2.75	2.28	MGR20L	1.8
SL1.250-MGT20-3.5	1	AP1/8-AP1/4	M12-M20	2.13	1.18	1.250	3.50	2.28	MGR30L	3.3
ST20-MGT6-65	2	No.2-No.12	M2-M6	1.42	.63	20mm	2.56	1.57	MGR16	1.1
ST25-MGT12-70	2	AU1/4-AU7/16 AU1/2-AU3/4	M6-M12	1.61	.79	25mm	2.76	1.97	MGR20L	1.8
ST32-MGT20-90	2	AP1/8-AP1/4	M12-M20	2.13	1.18	32mm	3.54	2.17	MGR30L	3.3

- *AU3/8 is included in the MGT20 series
- MGT set screw is included, tap holder and wrench must be ordered separately

CAUTION

Cannot be used with machining center without synchronized tapping function.

ACCESSORIES



STRAIGHT SHANK

TAPPING RANGE: No.0-No.6 (M1-M3)

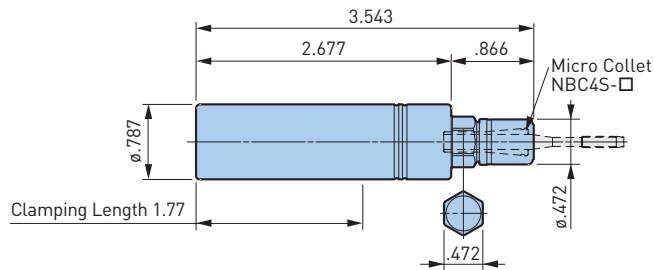

Catalog Number	Tapping Range d (Inch)	Tapping Range d (Metric)	Wrench	Weight (lbs.)
ST20-MGT3-90	No.0-No.6	M1-M3	MGR12	.4

- Nut is included, collet and wrench must be ordered separately
- When attaching or detaching the tap, a commercially available flat wrench (12mm width) is also required
- Not capable of supplying coolant through the holder body

ACCESSORIES



CAUTION

Cannot be used with machining center without synchronized tapping function.

CKB CYLINDRICAL SHANK

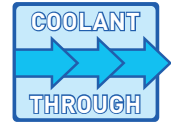
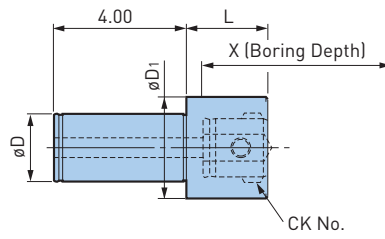

Catalog Number	Reference Number	øD	CK	øD1	L	X	Weight (lbs.)
SL1.00-CKB5-51	11.361.052	1.000	CKB5	1.968	2.000	4.244	2.0
SL1.25-CKB6-51	11.361.162	1.250	CKB6	2.500	2.000	4.800	3.5
SL1.50-CKB6-51	11.361.262	1.500	CKB6	2.500	2.000	4.800	4.0
SL2.00-CKB6-51	11.361.462	2.000	CKB6	2.500	2.000	4.800	5.0
-CKB7-83	11.361.474	2.000	CKB7	3.543	3.268	7.875*	11.0

• Head and insert must be ordered separately

MEGA MICRO CHUCK

CLAMPING RANGE: ϕ .018"-.238" (ϕ .45-6.05mm)

For Micro Drill & End Mill Applications

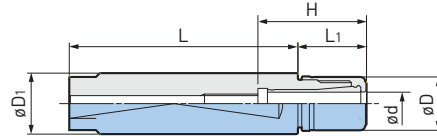
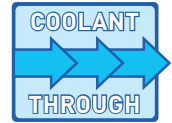

Catalog Number	ϕd	ϕD	ϕD_1	L	L ₁	H	Collet	Nut	Wrench
SL16-MEGA6S-60	.018-.238	.551	16mm	2.36	.71	1.12-1.93	NBC6S-□	MGN6S	MGR14
SL20-MEGA6S-40	.018-.238	.551	20mm	1.57	.71	1.12-1.93	NBC6S-□	MGN6S	MGR14
-80				3.15					
SL15.875-MEGA6S-60	.018-.238	.551	.625	2.36	.71	1.12-1.93	NBC6S-□	MGN6S	MGR14

- MEGA MICRO NUT is included, collet and wrench must be ordered separately
- Center through coolant supply is available

ACCESSORIES



NEW BABY CHUCK

CLAMPING RANGE: ϕ .098"-.787" (ϕ 2.5-20mm)

For Drills, Reamers, Taps & Finishing End Mills

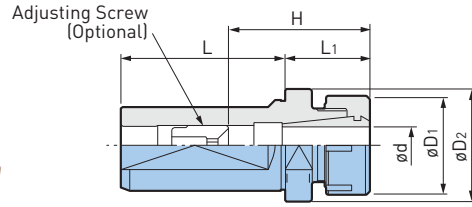
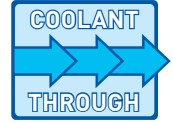

Stopper Type:
Flange as a stopper enables
presetting of the tool away from
machine and minimizes downtime.

Catalog Number	ϕd	ϕD	$\phi D1$	$\phi D2$	L	L1	H	Collet	Nut	Wrench
SLS25-NBS13-30	.098-.512	1.378	25mm	1.25	2.12	1.18	1.61-2.36	NBC13-□	NBN13	NBK13
-60						2.36				
SLS32-NBS13-30	.098-.512	1.378	32mm	1.55	2.28	1.18	1.61-2.36	NBC13-□	NBN13	NBK13
-60						2.36				
-100						3.94				
-NBS20-30	.098-.787	1.811	32mm	1.79	2.28	1.18	1.88-2.55	NBC20-□	NBN20	NBK20
-60						2.36				
-100						3.94				
SLS40-NBS13-30	.098-.787	1.378	40mm	1.94	2.67	1.18	1.61-2.36	NBC13-□	NBN13	NBK13
-60						2.36				
-100						3.94				
-NBS20-30	.098-.787	1.811	40mm	1.94	2.67	1.18	1.88-2.55	NBC20-□	NBN20	NBK20
-60						2.36				
-100						3.94				

- NEW BABY NUT is included, collet, wrench and adjusting screw must be ordered separately
- Center through coolant supply is available
- "H" indicates the adjustment length with an adjusting screw

ACCESSORIES





A.6 CYLINDRICAL & N/C LATHE

NEW BABY CHUCK

CLAMPING RANGE: ϕ .010"-.787" (ϕ .25-20mm)

For Drills, Reamers, Taps & Finishing End Mills

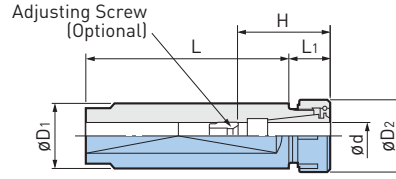
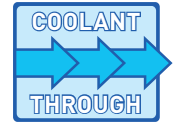

Fig. 1

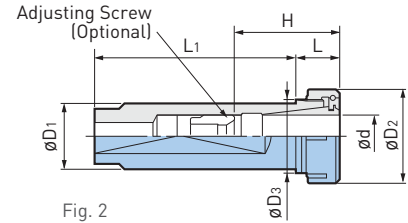

Fig. 2

Catalog Number	Fig.	ϕd	ϕD_1	ϕD_2	ϕD_3	L	L1	H	Collet	Nut	Wrench		
SL16-NBS6-40	1	.010-.236	16mm	.787	-	1.57	.59	.79-1.57	NBC6-□	NBN6	NBK6		
3.15													
.020-.315		1.57		.65		.91-1.65	NBC8-□	NBN8	NBK8				
		3.15											
-NBS10-40	2	.059-.394	20mm	1.181	.83	1.57	1.46	1.38-1.77	NBC10-□	NBN10	NBK10		
-80						3.15							
SL20-NBS6-40	1	.010-.236		20mm		.787	-	1.57	.59	.79-1.57	NBC6-□	NBN6	NBK6
-80								3.15					
-NBS8-40		.020-.315	1.57		.65	.91-1.65		NBC8-□	NBN8	NBK8			
-80			3.15										
-NBS10-40	2	.059-.394	22mm	1.181	.83	1.57	.71	1.38-1.77	NBC10-□	NBN10	NBK10		
-80						3.15							
-NBS13-40	.098-.512	1.57		1.61-2.36		NBC13-□	NBN13	NBK13					
-80		3.15											
SL22-NBS6-40	1	.010-.236	22mm	.787	-	1.57	.59	.79-1.57	NBC6-□	NBN6	NBK6		
-80						3.15							
-NBS8-40		.020-.315		1.57		.65	.91-1.65	NBC8-□	NBN8	NBK8			
-80				3.15									
-NBS10-40	2	.059-.394	25mm	1.181	1.02	1.57	.71	1.38-1.77	NBC10-□	NBN10	NBK10		
-80						3.15							
-NBS13-40	.098-.512	1.57		1.61-2.36		NBC13-□	NBN13	NBK13					
-80		3.15											
SL25-NBS6-80	1	.010-.236	25mm	.787	-	3.15	.59	.79-1.57	NBC6-□	NBN6	NBK6		
-120						4.72							
-NBS8-80		.020-.315		3.15		.65	.91-1.65	NBC8-□	NBN8	NBK8			
-120				4.72									
-NBS10-80	2	.059-.394	25mm	1.181	1.02	3.15	.71	1.38-1.77	NBC10-□	NBN10	NBK10		
-120						4.72							
-NBS13-80	.098-.512	3.15		1.61-2.36		NBC13-□	NBN13	NBK13					
-120		4.72											
-NBS16-80	.098-.630	3.15	1.77-2.56	NBC16-□	NBN16	NBK16							
-120		4.72											

Catalog Number	Fig.	ød	øD1	øD2	øD3	L	L1	H	Collet	Nut	Wrench	
SL25.4-NBS6-80	1	.010-.236	1.000	.787	—	3.15	.59	.79-1.57	NBC6-□	NBN6	NBK6	
4.72												
-NBS8-80		.020-.315		.987		3.15	.65	.91-1.65	NBC8-□	NBN8	NBK8	
4.72												
-NBS10-80		.059-.394		1.181		3.15	.71	1.38-1.77	NBC10-□	NBN10	NBK10	
4.72												
-NBS13-80	2	.098-.512	32mm	1.377	1.02	3.15	.85	1.61-1.97	NBC13-□	NBN13	NBK13	
4.72												
-NBS16-80		.098-.630		1.653		1.26	3.15	1.89	1.77-2.56	NBC16-□	NBN16	NBK16
4.72												
SL32-NBS13-100	1	.098-.512	32mm	1.377	—	3.94	.85	1.61-2.36	NBC13-□	NBN13	NBK13	
5.91												
-NBS16-100		.098-.630		1.653		3.94	1.77-2.56	NBC16-□	NBN16	NBK16		
5.91												
-NBS20-100	2	.098-.787	1.811	1.42	3.94	1.89-2.56	NBC20-□	NBN20	NBK20			
5.91												

- NEW BABY NUT is included, collet, wrench and adjusting screw must be ordered separately
- Center through coolant supply is available
- "H" indicates the adjustment length with an adjusting screw

ACCESSORIES



MEGA ER GRIP

CLAMPING RANGE: ϕ .108"-.787" (ϕ 2.75-20mm) For Drills, Reamers, Taps & Finishing End Mills

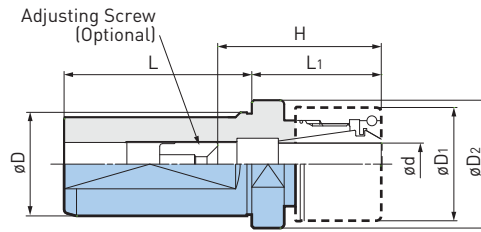
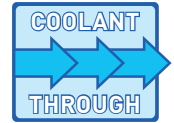

Stopper Type:
Flange as a stopper enables presetting of the tool away from machine and minimizes downtime.

Catalog Number	ϕd	ϕD	ϕD_1	ϕD_2	L	L ₁	H	Collet	Nut (NOT Included)	Wrench
SLS25-MEGAER20-45NL	.108-.512	25mm	1.378	1.26	2.13	1.77	1.65-2.44	ERC20-□	MERN20*	MGR35L
-75NL						2.95				
SLS32-MEGAER20-45NL	.108-.512	32mm	1.378	1.56	2.28	1.77	1.65-2.44	ERC20-□	MERN20*	MGR35L
-75NL						2.95				
-MEGAER32-45NL	.108-.787		1.969	1.97		1.77	1.85-2.68	ERC32-□	MERN32*	MGR50L
-75NL						2.95	1.97-2.68			
SLS40-MEGAER20-45NL	.108-.512	40mm	1.378	1.95	2.68	1.77	1.65-2.44	ERC20-□	MERN20*	MGR35L
-75NL						2.95				
-MEGAER32-45NL	.108-.787		1.969	1.97		1.77	1.97-2.68	ERC32-□	MERN32*	MGR50L
-75NL						2.95				

*Nut, adjusting screw, balance screws, collet and wrench are not included

- Center through coolant supply is available
- "H" indicates the adjustment length with an adjusting screw

ACCESSORIES



*MEGA NUT is the recommended nut to achieve high accuracy and clamping force

CAUTION

To maintain the accuracy of the tool assembly, do not use collets and nuts manufactured by another company with the chuck body of BIG's MEGA ER GRIP. We cannot guarantee the accuracy statement for our collets if they are assembled on the chuck body of another manufacturer.

EXAMPLE

Nuts	+	Collet	+	Body
MEGA ER PERFECT SEAL Model MERPS20-030035				
MEGA ER NUT Model MERN20				
MEGA ER SOLID NUT Model MER20SN				
ER NUT Model ERN20				
		MEGA ER Collet ERC20-3AA		MEGA ER GRIP SLS25-MEGA ER20-45/NL

• Collet and nut must be ordered separately.

MEGA ER GRIP

CLAMPING RANGE: ϕ .075"-.512" (ϕ 1.9-13mm) For Drills, Reamers, Taps & Finishing End Mills

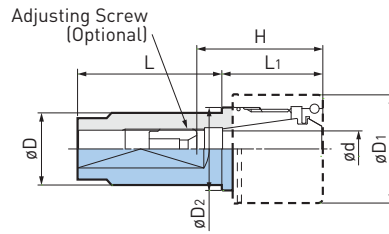
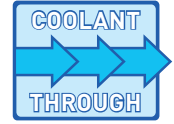

Catalog Number	ϕd	ϕD	ϕD_1	ϕD_2	L	L ₁	H	Collet	Nut (NOT Included)	Wrench
SL16-MEGAER11-40NL	.108-.236	16mm	.750	—	1.57	.750	.906-1.57	ERC11-□	ERN11	NBK6
-80NL					3.15					
SL20-MEGAER11-40NL	.108-.236	20mm	.750	—	1.57	.750	.906-1.57	ERC11-□	ERN11	NBK6
-80NL					3.15					
-MEGAER16-40NL	.075-.394		1.181	.91	1.57	1.10	1.38-1.85	ERC16-□	MERN16*	MGR30L
-80NL					3.15					
SL25-MEGAER11-60NL	.108-.236	25mm	.750	—	2.36	.750	.906-1.57	ERC11-□	ERN11	NBK6
-100NL					3.94					
-MEGAER16-60NL	.075-.394		1.181	—	2.36	1.10	1.38-1.85	ERC16-□	MERN16*	MGR30L
-100NL					3.94					
-MEGAER20-60NL	.108-.512		1.378	1.06	2.36	1.18	1.65-2.44	ERC20-□	MERN20*	MGR35L
-100NL					3.94					
-MEGAER25-60NL	.108-.630		1.654	1.32	2.36	1.89	1.73-2.64	ERC25-□	MERN25*	MGR42L
-100NL					3.94					
SL19.05-MEGAER11-40NL	.108-.236	.750	.750	—	1.57	.750	.906-1.57	ERC11-□	ERN11	NBK6
-80NL					3.15					
-MEGAER16-40NL	.075-.394		1.181	.91	1.57	1.10	1.38-1.85	ERC16-□	MERN16*	MGR30L
-80NL					3.15					

*Nut, adjusting screw, balance screws, collet and wrench are not included

- Center through coolant supply is available
- "H" indicates the adjustment length with an adjusting screw

ACCESSORIES



*MEGA NUT is the recommended nut to achieve high accuracy and clamping force

CAUTION

To maintain the accuracy of the tool assembly, do not use collets and nuts manufactured by another company with the chuck body of BIG's MEGA ER GRIP. We cannot guarantee the accuracy statement for our collets if they are assembled on the chuck body of another manufacturer.

SMART DAMPER TURNING ANTI-VIBRATION BORING BAR

Integrated Damping System

Unprecedented machining depths without chatter is made possible with this heavyweight, strengthened dynamic damper.

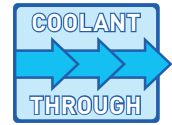

- Machining Dia.: $\phi 1.58$ or more
- Depth: L/D $\phi 7 \times d$

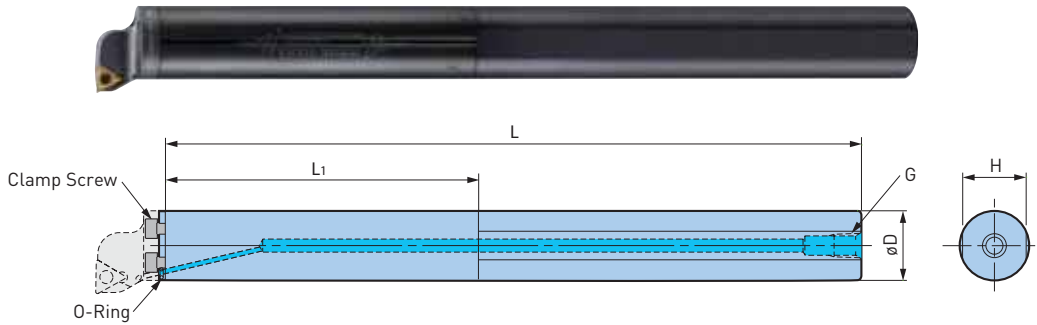

Catalog Number	Cartridge	ϕD	L	L1	H	G	Clamp Bolt (1 pc.)	O-Ring Set (2 pcs.)
ST32-SDB40DP-320	B32-□	32mm	12.60	5.67	1.18	PT1/4	C0510 (M5×10L)	SDB200R
ST40-SDB50DP-410	B40-□	40mm	16.14	6.69	1.46	PT3/8	C0610 (M6×10L)	SDB200R
ST1.250-SDB40DP-12.5	B32-□	1.25	12.50	5.67	1.18	NPT1/4	C0510 (M5×10L)	SDB200R
ST1.500-SDB50DP-16	B40-□	1.50	16.00	6.69	1.47	NPT1/4	C0610 (M6×10L)	SDB200R

- Clamp Bolts (3 pcs.) and O-Rings (2 pcs.) are included
- Cartridge must be ordered separately
- Insert must be ordered separately
- Designed to be capable of supplying coolant through body
- Do not clamp the L1 section, where the anti-vibration mechanism is located

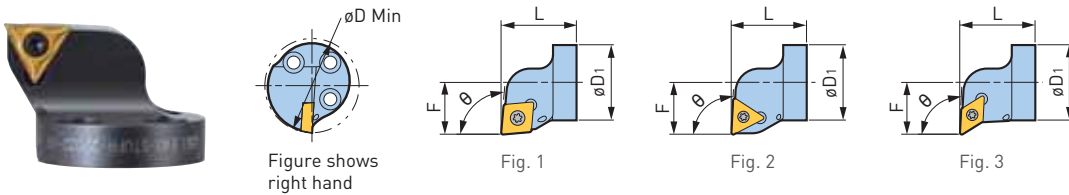

Catalog Number	Fig.	Insert	Hand	ϕD Min	ϕD	F	L	θ	Set Screw
B32-SCLCR-22032-12	1	CC1204	Right Hand	1.57	1.26	.87	1.26	95°	S5S-20IP
-STUCR-22032-11	2	TC1102						93°	S2.5S-7IP
-STUPR-22032-16		TP1604							S4S-15IP
-SDUCR-22032-11	3	DC11T3							
B40-SCLCR-27032-12	1	CC1204	Right Hand	1.97	1.57	1.06	1.26	95°	S5S-20IP
-STUCR-27032-11	2	TC1102						93°	S2.5S-7IP
-STUPR-27032-16		TP1604							S4S-15IP
-SDUCR-27032-11	3	DC11T3							

- A single chip clamping screw is included with each cartridge
- Insert must be ordered separately, an ISO standard insert is fitted
- Insert Clamp Screw Set (option) comprises 10 pcs. of screw and 1 pc. of wrench
- Left hand models are B.T.O.; please contact BIG KAISER for details

CENTERING HOLDER FOR LATHE

Easy And Reliable Centering Adjustment For Turret Lathe Sleeve Holder

CLAMPING RANGE: \varnothing .5-20mm

The rotation center of the workpiece and the center of the turret pot may be misaligned not only in the center height direction, but also in the X-axis direction. In order to easily correct the deviation of both directions at the same time, a polar coordinate system combining rotary and linear movement is used. Single two way adjusting bolt completes adjustment of center height both up and down.

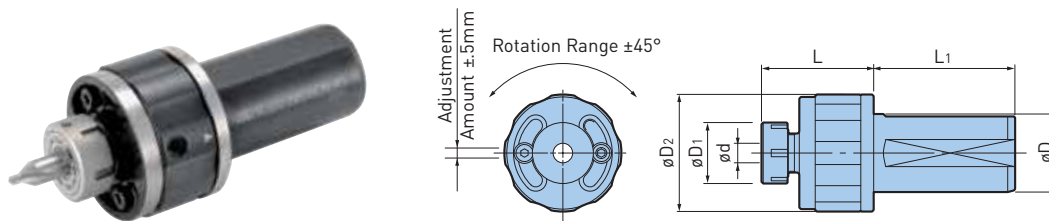
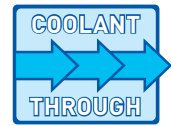

Catalog Number	$\varnothing d$	$\varnothing D$	$\varnothing D_1$	$\varnothing D_2$	L	L ₁	Weight (lbs)
SLS32-NBS8CH-45	.020-.315	1.260	.984	1.890	1.811	2.283	3.5
SLS40-NBS20CH-60	.098-.787	1.575	1.811	2.913	2.362	2.677	5.5

- NEW BABY NUT is included, collet and wrench must be ordered separately
- Center through coolant supply is available

ACCESSORIES

<p>COLLET PG. 338</p>	<p>NUT PG. 350</p>	<p>PERFECT SEAL PG. 348</p>	<p>WRENCH PG. 350</p>
---------------------------	------------------------	---------------------------------	---------------------------

LATHE MASTER FOR LATHE

Setup Of Tool Offset Is Possible Without Trial Cut

- Effective in reducing setup time for NC Lathes
- Detectable with various tool bits for external, internal and face turning

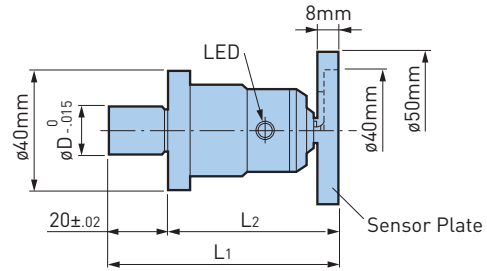

Catalog Number	øD	L1	L2	Repeatability	Battery
LM-15	15mm	75mm	55mm	±2µ	BR425
LM-30	30mm	65mm	45mm		SR44 x 2

CAUTION ⚠

Machine and tools must be electro-conductive for measurement.

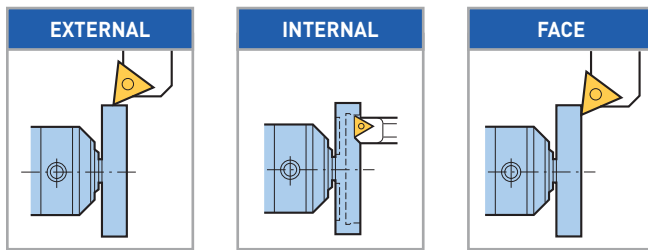

Clamp the øD section of the LATHE MASTER with chuck jaws.
LED illuminates when the tip of the tool touches the sensor plate.

COLLAR SET (OPTIONAL)

If the chuck jaw diameter does not fit, an optional collar set is available.

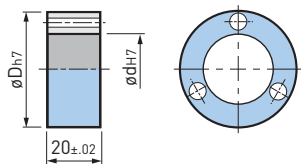

Catalog Number	Inner Diameter ød (mm)	Outer Diameter øD (mm)
LM15CS	15	20, 25, 30 (1 pc each)
LM30CS	30	35, 40, 45, 50 (1 pc each)

CENTERING TOOL FOR SMALL LATHE

Static Dial Gauge For Easy Centering

- Centering the tool holder is simplified since the dial gauge position is static and in front
- Easy setting with a fine adjustment mechanism (adjustment amount: .079)
- Magnetic base allows for flexible mounting positions

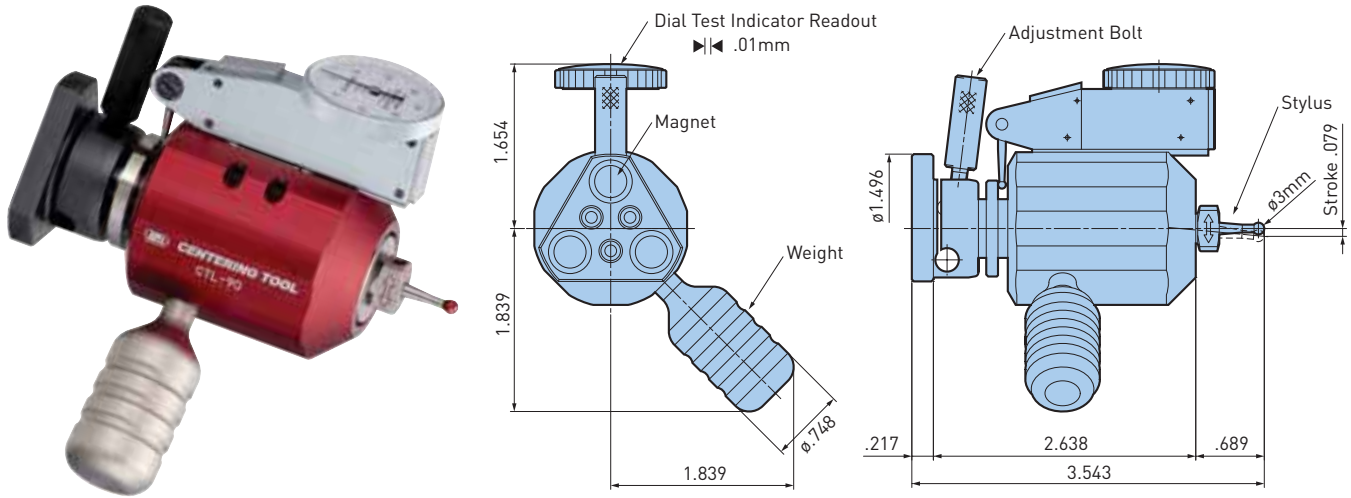

Catalog Number	Min. Scale	Max. Spindle Speed	Weight (lbs.)	Replacement Stylus
CTL-90	.01mm	50 RPM	.88 (Including Stylus)	ST3-CT90



BCV/BBT/HSK-T/BIG CAPTO SHANK

MILL-TURN TOOLING



MILL-TURN A.7



BCV SHANKS	300-305
TURNING TOOLS BCV SYSTEM	300-301
BASIC HOLDER	302
SQUARE HOLDER	303
BORING BAR HOLDER	304
BSL SPARE PARTS	305
BBT SHANKS	306-311
TURNING TOOLS SYSTEM	306-307
BASIC HOLDER	308
SQUARE HOLDER	309
BORING BAR HOLDER	310
BSL SPARE PARTS	311
HSK-T SHANKS	312-317
TURNING TOOLS SYSTEM	312-313
BASIC HOLDER	314
SQUARE HOLDER	315
BORING BAR HOLDER	316
BSL SPARE PARTS	317
BIG CAPTO SHANKS	318-325
TURNING TOOLS SYSTEM	318-319
BASIC HOLDER	320
INTEGRAL MODEL	321
SQUARE HOLDER	322-323
BORING BAR HOLDER	324
BSL SPARE PARTS	325
ACCESSORIES	326-331
SELECTION GUIDE	326-327
MTC CARTRIDGES	328-329
SPARE PARTS	330-331

45°

* In case of DN44 insert, please replace the standard carbide shim with DNS1506 (option)

S TYPE PG. 302
BASIC HOLDER

Catalog Number	L
BCV40Y-S50-3	3
BCV50Y-S50-3.5	3.5
-S50-4.5	4.5

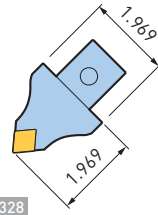

S TYPE CARTRIDGE PG. 328

No.1

S50-DCLNN-00050-12

No.2

S50-DTJNR-00050-16(22)
-DTJNL-00050-16(22)

No.3

S50-DDHNN-00050-15

No.4

S50-DDJNR-00050-15
-DDJNL-00050-15

No.5

S50-SVQBN-00050-16

90°

* In case of DN44 insert, please replace the standard carbide shim with DNS1506 (option)

F TYPE PG. 302
BASIC HOLDER

Catalog Number	L
BCV40Y-F63-4.125	4.125
BCV50Y-F63-5.125	5.125

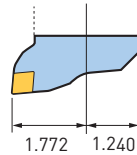
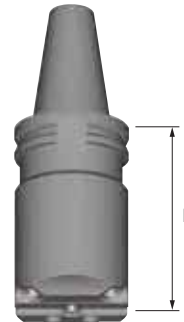

F TYPE CARTRIDGE PG. 329

No.10

F63-DCLNR-45035-12(16)
-DCLNL-45035-12(16)

No.12

F63-DTJNR-45035-16
-DTJNL-45035-16

No.13

F63-DDJNR-45035-15
-DDJNL-45035-15

S TYPE PG. 302 BASIC HOLDER

Catalog Number	L
BCV40Y-S63-2.625	2.625
BCV50Y-S63-3.125	3.125
-S63-4.125	4.125

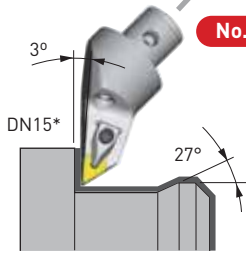
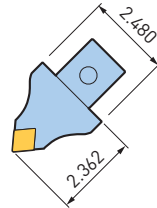
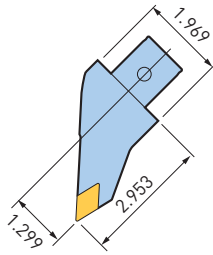

S50-DDJNR-33075-15
-DDJNL-33075-15

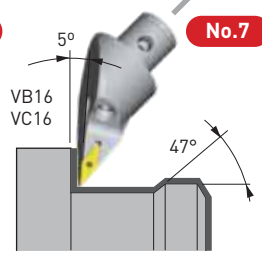

S50-SVLBR-33075-16
-SVLBL-33075-16

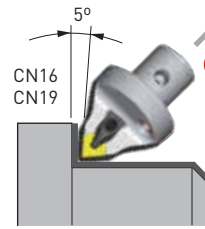

S63-DCLNN-00060-16
-DCLNN-00060-19

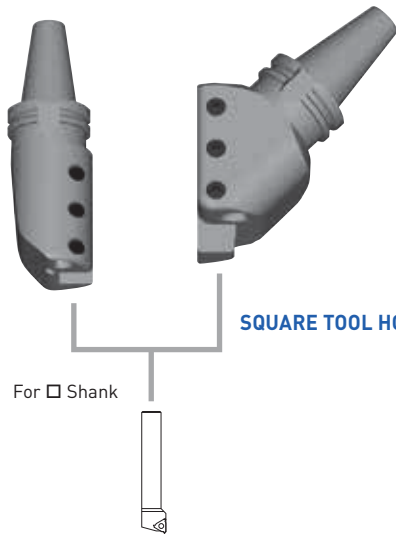

SQUARE TOOL HOLDERS PG. 303

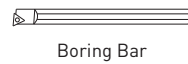

Boring Bar

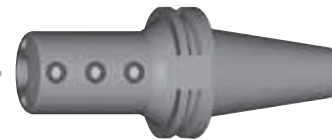

BORING BAR HOLDER PG. 304

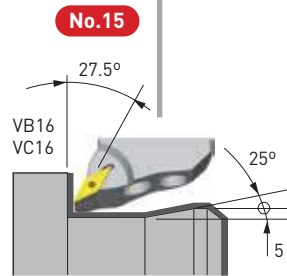

F63-SVQBR-45035-16
-SVQBL-45035-16

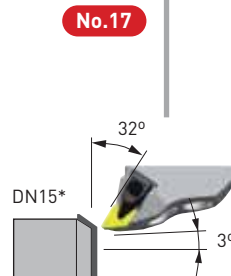

F63-DDUNR-45035-15
-DDUNL-45035-15

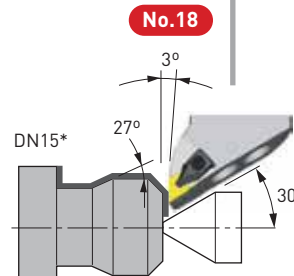

F63-DDJNR-45055-15
-DDJNL-45055-15

A.7 MILL-TURN

BASIC HOLDER—BCV

Modular Tooling System for Turning Applications

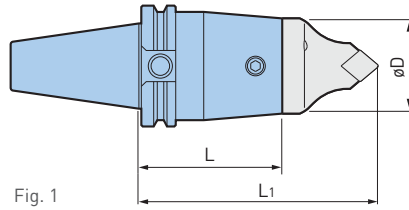

Fig. 1

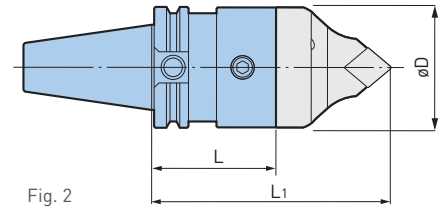

Fig. 2



Catalog Number	Type	Fig.	øD	L	L1	Clamp Screw (2x)
BCV40Y-S50-3	S50	1	1.969	3.000	4.97	10.690.435
-S63-2.625	S63	2	2.480	2.625	4.99	10.690.436
BCV50Y-S50-3.5	S50	1	1.969	3.500	5.47	10.690.435
-S50-4.5				4.500	6.47	
-S63-4.125	S63	2	2.480	4.125	6.49	10.690.436

- Clamping screw is included

ACCESSORIES



MILL-TURN A.7

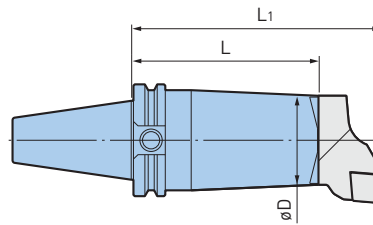

Catalog Number	Type	øD	L	L1
BCV40Y-F63-4.125	F63	2.480	4.125	5.50
BCV50Y-F63-5.125	F63	2.480	5.125	6.50

- Wrench must be ordered separately
- Basic Holders include M10x22L and M10x25L screws for clamping cartridges

ACCESSORIES



SQUARE HOLDER—BCV

For Square Holder Turning Applications

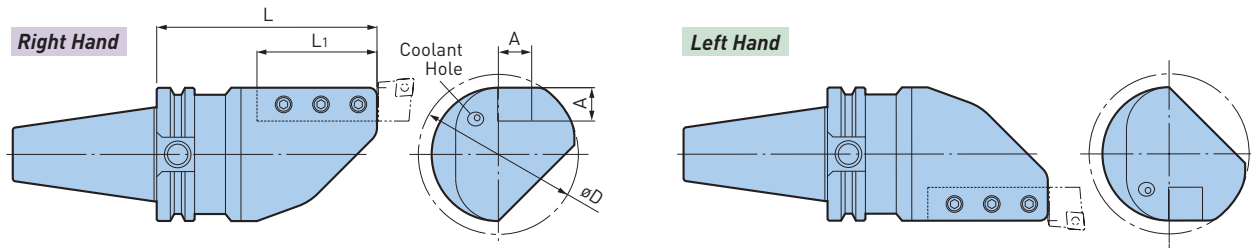

Catalog Number	Hand	A	L	L1	øD
BCV40Y-180-BH1.000L-5	L	1.000	5.00	3.50	3.74
-180-BH1.000R-5	R				
BCV50Y-180-BH1.000L-5	L	1.000	5.00	3.42	4.92
-180-BH1.000R-5	R				
-180-BH1.250L-5	L	1.250	5.00	3.35	5.04
-180-BH1.250R-5	R				

A.7 MILL-TURN

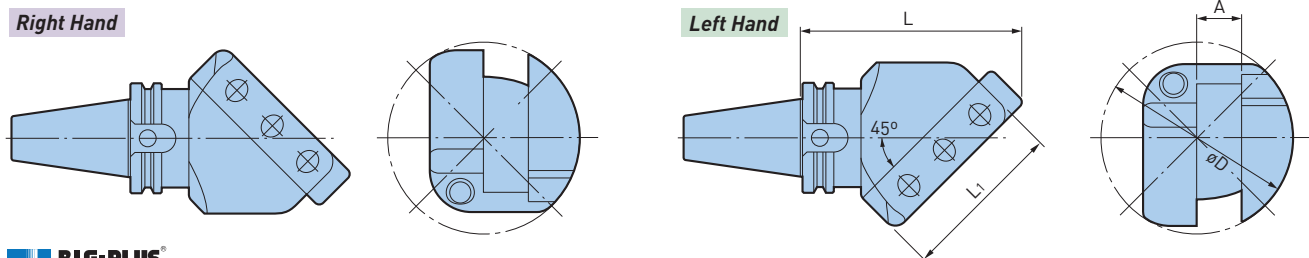

Catalog Number	Hand	A	L	L1	øD
BCV40Y-45-BH1.000L-4.75	L	1.000	4.75	3.43	4.33
-45-BH1.000R-4.75	R				
BCV50Y-45-BH1.000L-5.5	L	1.000	5.50	3.35	5.32
-45-BH1.000R-5.5	R				
-45-BH1.250L-5.5	L	1.250	5.50	3.35	6.69
-45-BH1.250R-5.5	R				

BORING BAR HOLDER—BCV

CLAMPING RANGE: ϕ .625"-2.000"

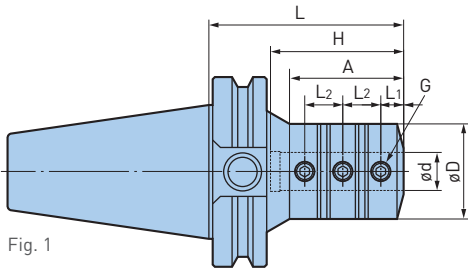

Fig. 1

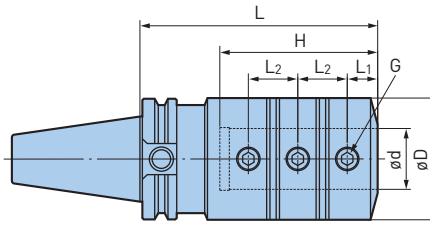

Fig. 2



Catalog Number	Fig.	ϕd	ϕD	L	L ₁	L ₂	H	A	G
BCV40Y-BSL.625-3.5	1	.625	1.575	3.50	.394	.787	2.68	2.48	M10P1.25
-BSL.750-3.5		.750	1.929	3.50	.472	.787	2.52	2.56	
-BSL1.000-4		1.000	2.165	4.00	.551	.906	2.91	3.25	M12P1.5
-BSL1.250-5	2	1.250	2.520	5.00	.630	1.024	3.27	—	M16P1.5
-BSL1.500-5.5		1.500	3.150	5.50	.709	1.260	3.86	—	
BCV50Y-BSL.625-3.5	1	.625	1.575	3.50	.394	.827	2.72	2.48	M10P1.25
-BSL.750-3.5		.750	1.969	3.50	.472	.787	2.52	2.36	
-BSL1.000-4		1.000	2.165	4.00	.551	.906	2.91	2.76	M16P1.5
-BSL1.250-4.5		1.250	2.520	4.50	.394	1.024	3.27	3.35	
-BSL1.500-5		1.500	3.150	5.00	.709	1.260	3.86	4.09	M16P1.5
-BSL2.000-5.25		2.000	3.543	5.25	.709	1.417	4.53	4.50	

- Plug A and Plug B are included
- Interchangeable between center-through and side-through coolant supply by using plugs

BSL SPARE PARTS—BCV

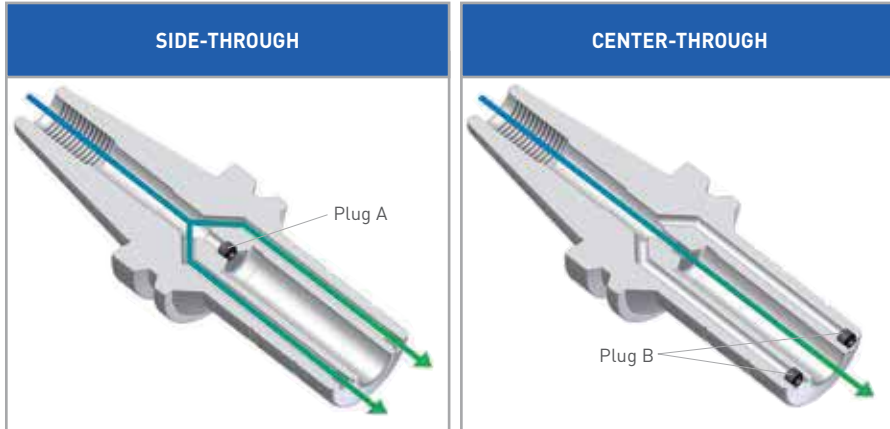

Catalog Number	Plug A	Plug B
BSL.625	M6xP1.0	M6xP1.0
BSL.750		
BSL1.000		
BSL1.250		
BSL1.500		
BSL2.000		

For BSL Side Lock Holder

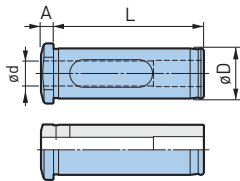

Catalog Number	ϕd	ϕD	L	A
BSL1.500-.375	.375	1.500	3.40	.27
-500	.500			
-625	.625			
-750	.750			
-1.000	1.000			
-1.250	1.250			
BSL2.000-.625	.625	2.000	4.00	.33
-750	.750			
-1.000	1.000			
-1.250	1.250			
-1.500	1.500			
-1.750	1.750			

45°

* When using a DN1506 insert (thickness: 6.35mm), replace the standard carbide shim with the DNS1506 (optional)

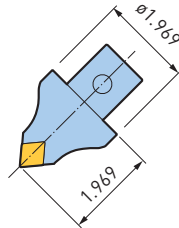

S TYPE PG. 308 BASIC HOLDER

Catalog Number	L
BBT40M-S50-75	2.95
BBT50M-S50-120	4.72

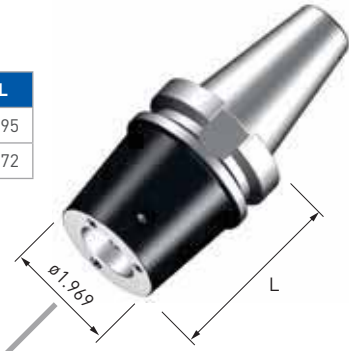

S TYPE CARTRIDGE PG. 328

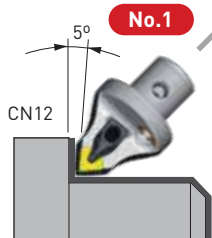
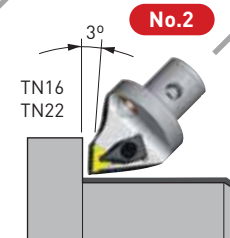
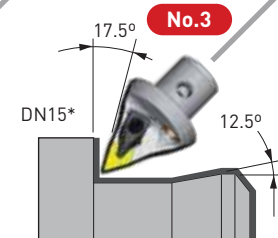
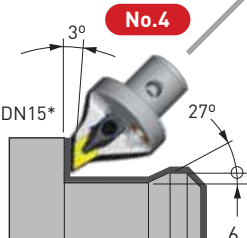
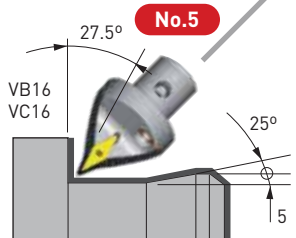
 No.1 CN12 S50-DCLNN-00050-12	 No.2 TN16 TN22 S50-DTJNR-00050-16(22) -DTJNL-00050-16(22)	 No.3 DN15* S50-DDHNN-00050-15	 No.4 DN15* S50-DDJNR-00050-15 -DDJNL-00050-15	 No.5 VB16 VC16 S50-SVQBN-00050-16
--	---	---	---	--

MILL-TURN A.7

90°

* When using a DN1506 insert (thickness: 6.35mm), replace the standard carbide shim with the DNS1506 (optional)

F TYPE PG. 308 BASIC HOLDER

Catalog Number	L	øD
BBT40M-F50-75	2.95	1.969
-105	4.13	
BBT50M-F63-70	2.76	2.480
-130	5.12	



S TYPE PG. 308 BASIC HOLDER



S TYPE PG. 328 CARTRIDGE

F TYPE PG. 329 CARTRIDGE

Catalog Number	f
F50	1.378
F63	1.772

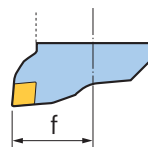

F TYPE CARTRIDGE PG. 329

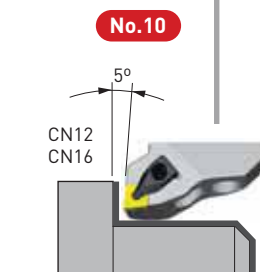
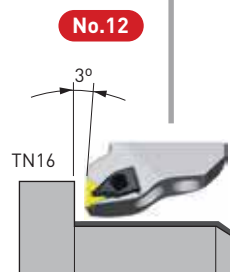
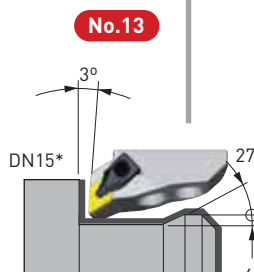
 No.10 CN12 CN16 F50-DCLNR-35035-12(16) -DCLNL-35035-12(16)	 No.12 TN16 F50-DTJNR-35035-16 -DTJNL-35035-16	 No.13 DN15* F50-DDJNR-35035-15 -DDJNL-35035-15
F63-DCLNR-45035-12(16) -DCLNL-45035-12(16)	F63-DTJNR-45035-16 -DTJNL-45035-16	F63-DDJNR-45035-15 -DDJNL-45035-15

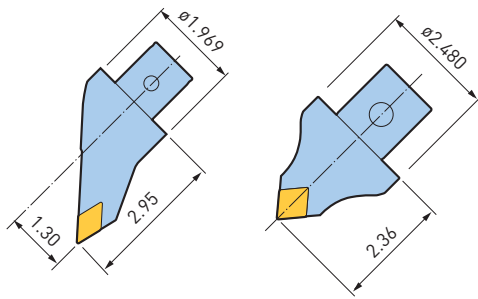

S TYPE PG. 308 BASIC HOLDER

Catalog Number	L
BBT40M-S63-65	2.56
BBT50M-S63-110	4.33

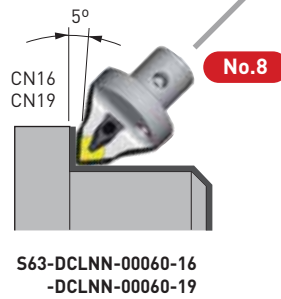
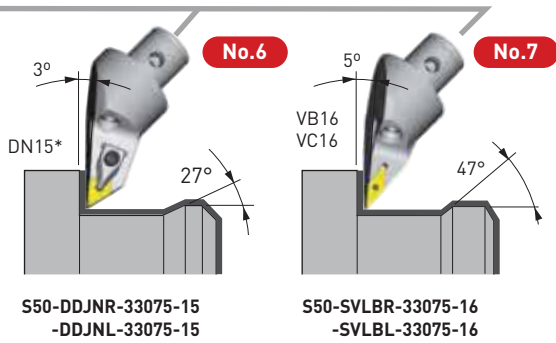

Internal Boring Bar
Internal Threading Tool



SIDE LOCK HOLDER PG. 310
For Boring Bar

Square Tool



SQUARE TOOL HOLDERS PG. 309

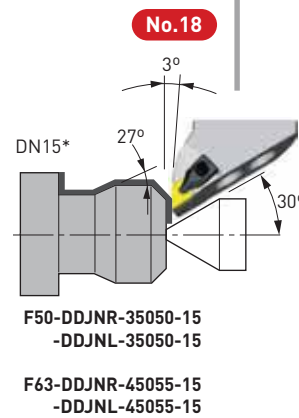
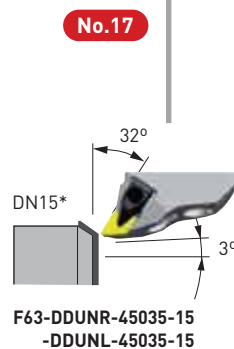
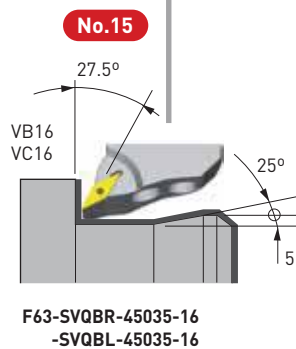

BASIC HOLDER—BBT

Modular Tooling System for Turning Applications

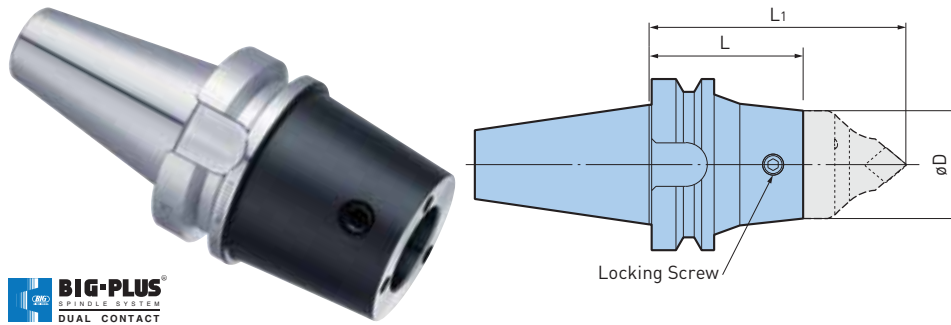

Catalog Number	Type	øD	L	L1	Locking Screw
BBT40M-S50-75	S50	1.969	2.953	4.92	10.690.435
-S63-65	S63	2.480	2.559	4.92	10.690.436
BBT50M-S50-120	S50	1.969	4.724	6.69	10.690.435
-S63-110	S63	2.480	4.331	6.69	10.690.436

ACCESSORIES



- Clamping screw is included

MILL-TURN A.7

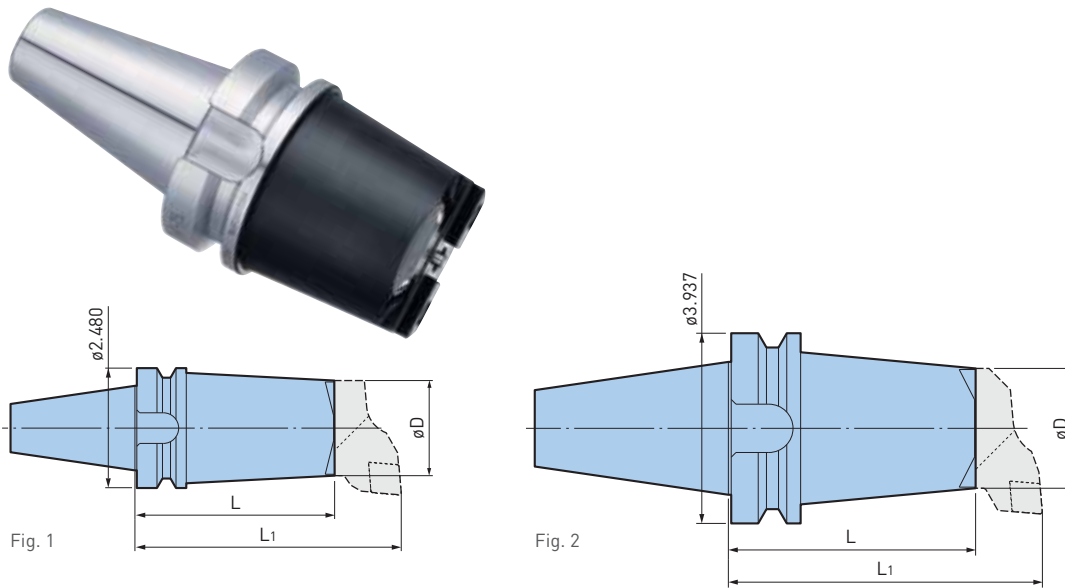

Catalog Number	Type	Fig.	øD	L	L1
BBT40M-F50-75	F50	1	1.969	2.953	4.33
-105				4.134	5.51
BBT50M-F63-70	F63	2	2.480	2.756	4.13
-130				5.118	6.50

ACCESSORIES



- Wrench must be ordered separately
- Basic Holders include M10x22L and M10x25L screws for clamping cartridges
- In case the coolant supply only from 1 of 2 coolant nozzles is required, use the flat head screw (M5 x 102)

SQUARE HOLDER—BBT

For Square Holder Turning Applications

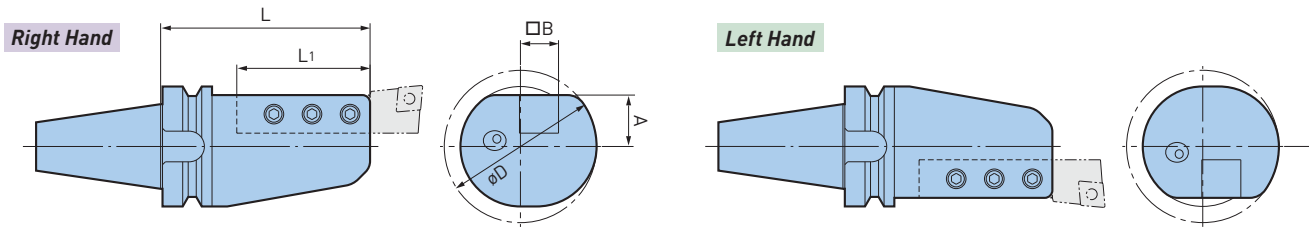

Catalog Number	Hand	$\square B$	L	L ₁	A	ϕD
BBT40M-180-BH20R-110	R	20mm	4.33	2.76	1.06	3.15
-BH20L-110	L					
-BH25R-130	R	25mm	5.12	3.54	1.24	3.54
-BH25L-130	L					
BBT50M-180-BH25R-140	R	25mm	5.51	3.54	1.97	4.72
-BH25L-140	L					

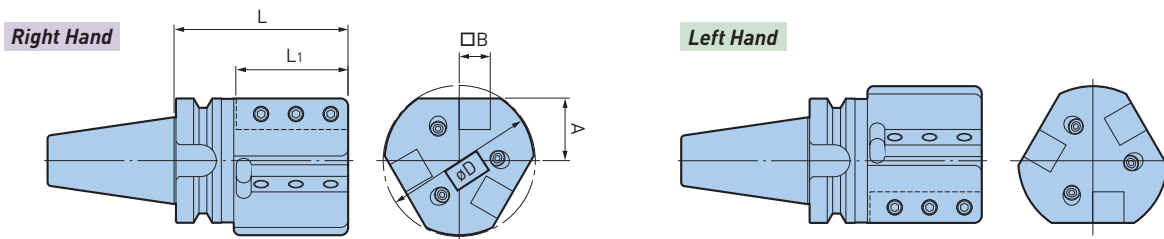

Catalog Number	Hand	$\square B$	L	L ₁	A	ϕD
BBT40M-180-3BH20R-110	R	20mm	4.33	2.76	1.38	3.54
-3BH20L-110	L					

CAUTION

60 degree indexing is required to the machine tool spindle.

BORING BAR HOLDER—BBT

CLAMPING RANGE: $\varnothing 8$ -50mm

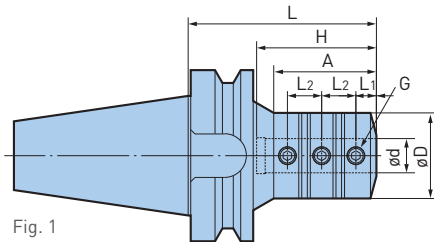

Fig. 1

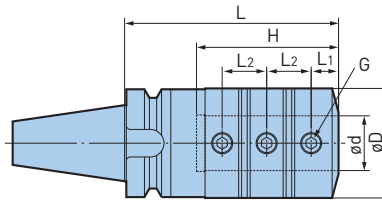

Fig. 2



Catalog Number	Fig.	$\varnothing d$	$\varnothing D$	L	L ₁	L ₂	H	A	G
BBT40M-BSL8-75	1	8mm	.984	2.95	.236	.394	1.57	1.57	M6 P1.0
-BSL10-80		10mm	1.142	3.15	.315	.472	1.97	1.77	M8 P1.0
-BSL12-90		12mm	1.339	3.54	.315	.630	2.17	2.09	M8 P1.0
-BSL16-100		16mm	1.575	3.94	.394	.827	2.68	2.56	M10 P1.25
-BSL20-100		20mm	1.969	3.94	.472	.787	2.76	2.64	M10 P1.25
-BSL25-110		25mm	2.165	4.33	.551	.906	2.91	3.27	M12 P1.5
-BSL32-125	2	32mm	2.520	4.92	.630	1.024	3.27	—	M12 P1.5
-BSL40-150		40mm	3.150	5.91	.709	1.260	3.86	—	M16 P1.5
BBT50M-BSL16-105	1	16mm	1.575	4.13	.394	.827	2.68	2.40	M10 P1.25
-BSL20-110		20mm	1.969	4.33	.472	.787	2.76	2.36	M10 P1.25
-BSL25-120		25mm	2.165	4.72	.551	.906	2.91	2.76	M12 P1.5
-BSL32-125		32mm	2.520	4.92	.630	1.417	3.27	3.15	M12 P1.5
-BSL40-135		40mm	3.150	5.31	.709	1.260	3.86	3.58	M16 P1.5
-BSL50-145		50mm	3.543	5.71	.709	1.417	4.53	4.02	M16 P1.5

- Plug A and Plug B are included
- Interchangeable between center-through and side-through coolant supply by using plugs

BSL SPARE PARTS—BBT

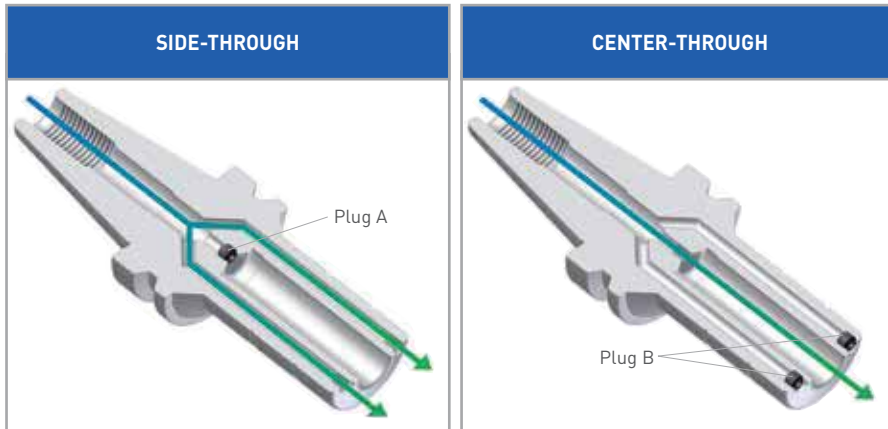

Right or Left Hand
Adjustment is Possible

Catalog Number	Plug A	Plug B
BSL8	M6x5L	M4x4L
BSL10		M5x5L
BSL16		
BSL20	M8x8L	M6x5L
BSL25		
BSL32		
BSL40	M10x10L	
BSL50		

• Plug A and Plug B are included

For BSL Side Lock Holder

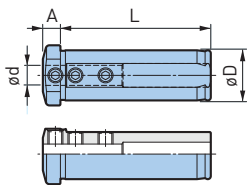

Fig. 1

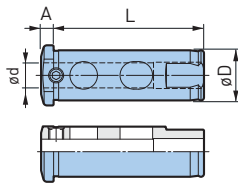

Fig. 2

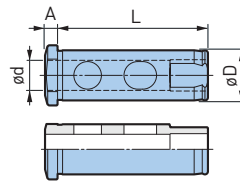
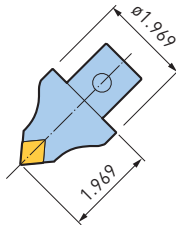

Fig. 3

Catalog Number	Fig.	ød	øD	L	A
BSLA20-6	1	6mm	20mm	2.36	.20
-8		8mm			.28
-10	2	10mm			.20
-12	3	12mm			.20
-16		16mm			.20
BSLA32-10	1	10mm			32mm
-12		12mm	.35		
-16	2	16mm	.24		
-20	3	20mm	.24		

45°

* When using a DN1506 insert (thickness: 6.35mm), replace the standard carbide shim with the DNS1506 (optional)



S TYPE PG. 314
BASIC HOLDER

Catalog Number	L
HSK-T50-S50-60	2.36
-T63-S50-60	2.36
-75	2.95
-100	3.93
-T100-S50-115	4.53

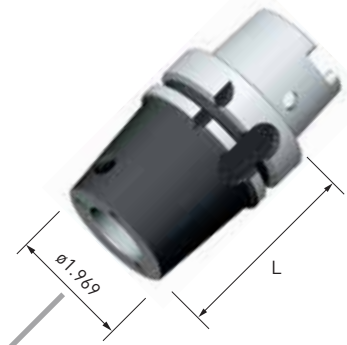

S TYPE CARTRIDGE PG. 328

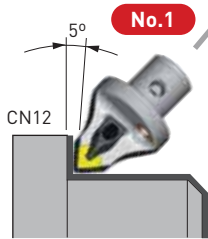

S50-DCLNN-00050-12

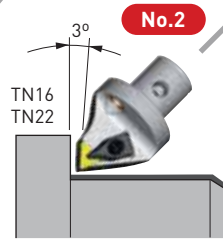

S50-DTJNR-00050-16(22)
-DTJNL-00050-16(22)

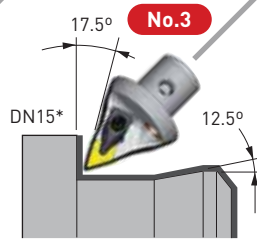

S50-DDHNN-00050-15

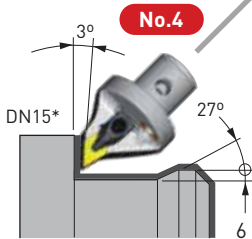

S50-DDJNR-00050-15
-DDJNL-00050-15

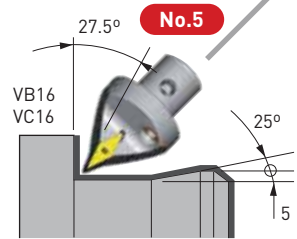

S50-SVQBN-00050-16

MILL-TURN A.7

90°

* When using a DN1506 insert (thickness: 6.35mm), replace the standard carbide shim with the DNS1506 (optional)

F TYPE PG. 329
CARTRIDGE

Catalog Number	F
F63	1.77

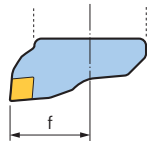

F TYPE PG. 314
BASIC HOLDER

Catalog Number	L
HSK-T63-F63-50	1.97
-75	2.95
-100	3.94
-130	5.12
-170	6.69
-T100-F63-100	3.94
-150	5.91



S TYPE PG. 314
BASIC HOLDER



S TYPE PG. 328
CARTRIDGE

- No.1
- No.3
- No.5
- No.8

F TYPE CARTRIDGE PG. 329

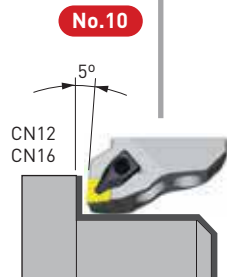

F63-DCLNR-45035-12(16)
-DCLNL-45035-12(16)

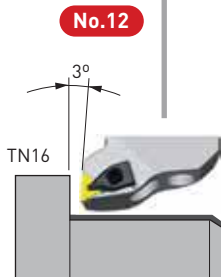

F63-DTJNR-45035-16
-DTJNL-45035-16

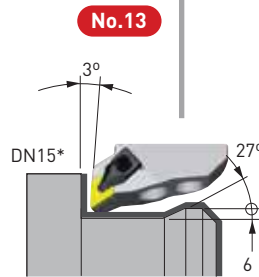

F63-DDJNR-45035-15
-DDJNL-45035-15

S TYPE PG. 314
BASIC HOLDER

Catalog Number	L
HSK-T63-S63-70	2.76
-90	3.94
-T100-S63-105	4.13

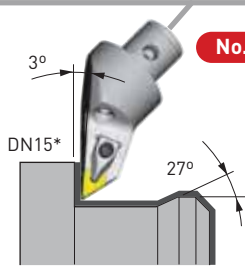
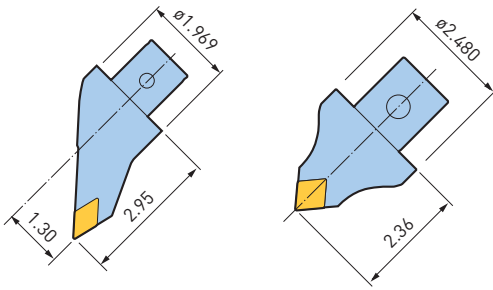

No.6

S50-DDJNR-33075-15
-DDJNL-33075-15

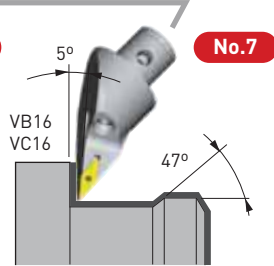

No.7

S50-SVLBR-33075-16
-SVLBR-33075-16

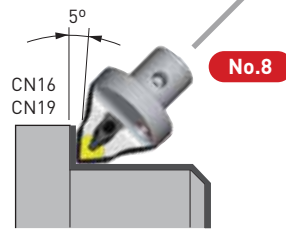

No.8

S63-DCLNN-00060-16
-DCLNN-00060-19

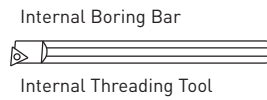

Internal Boring Bar

Internal Threading Tool



SIDE LOCK HOLDER PG. 316

For Boring Bar

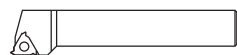

Square Tool



SQUARE TOOL HOLDERS PG. 315

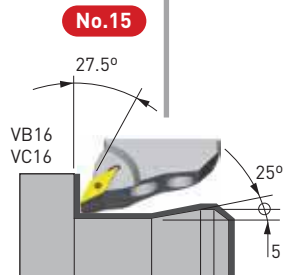

No.15

F63-SVQBR-45035-16
-SVQBL-45035-16

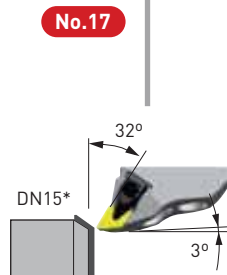

No.17

F63-DDUNR-45035-15
-DDUNL-45035-15

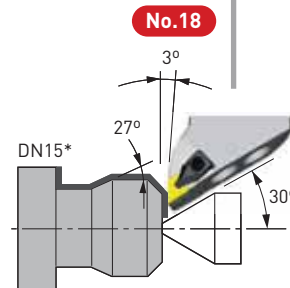

No.18

F63-DDJNR-45055-15
-DDJNL-45055-15

BASIC HOLDER—HSK-T Modular Tooling System for Turning Applications

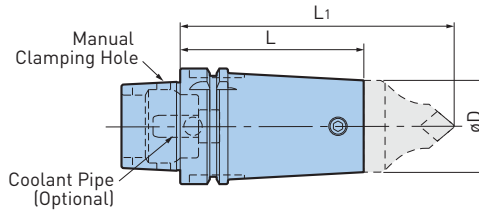

Catalog Number	Type	øD	L	L1	Locking Screw
HSK-T50-S50-60	S50	1.967	2.362	4.331	10.690.435
HSK-T63-S50-60	S50	1.969	2.362	4.331	10.690.435
-75			2.953	4.921	
-100			3.937	5.906	
HSK-T63-S63-70	S63	2.480	2.756	5.118	10.690.436
-90			3.543	5.906	
HSK-T100-S50-115	S50	1.969	4.528	6.496	10.690.435
HSK-T100-S63-105	S63	2.480	4.134	6.496	10.690.436

ACCESSORIES



• Clamping screw is included, coolant pipe must be ordered separately

MILL-TURN A.7

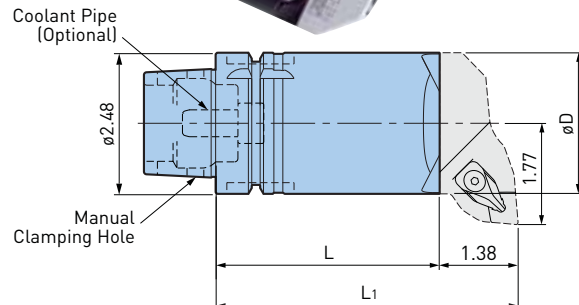

Fig. 1 (HSK-T63)

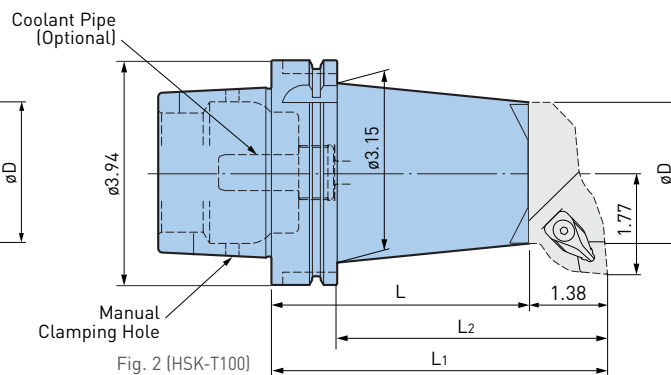

Fig. 2 (HSK-T100)

Catalog Number	Type	Fig.	øD	L	L1	L2
HSK-T63-F63-50	F63	1	2.480	1.969	3.346	—
-75				2.953	4.331	
-100				3.937	5.315	
-130				5.118	6.496	
-170				6.693	8.071	
HSK-T100-F63-100	F63	2	2.480	3.937	5.315	4.133
-150				5.906	7.283	6.102

ACCESSORIES



- Coolant pipe and wrench must be ordered separately
- Basic Holders include M10x22L and M10x25L screws for clamping cartridges
- In case the coolant supply only from 1 of 2 coolant nozzles is required, use the flat head screw (M5 x 102)

SQUARE HOLDER—HSK-T For Turning Applications

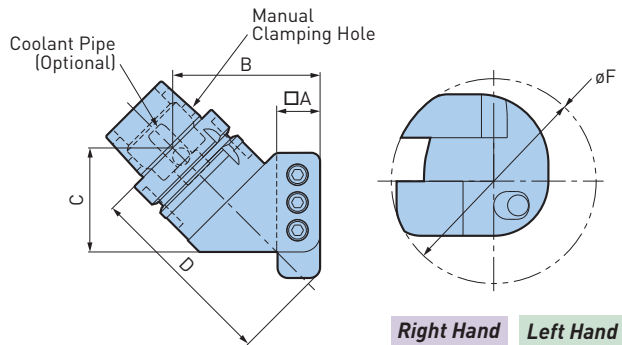

45° (ISO 12164-3)

Catalog Number	Hand	□A	B	C	D	øF
HSK-T63-45-BH25R-110	R	25mm	3.35	2.36	4.33	4.65
-BH25L-110	L					

CAUTION

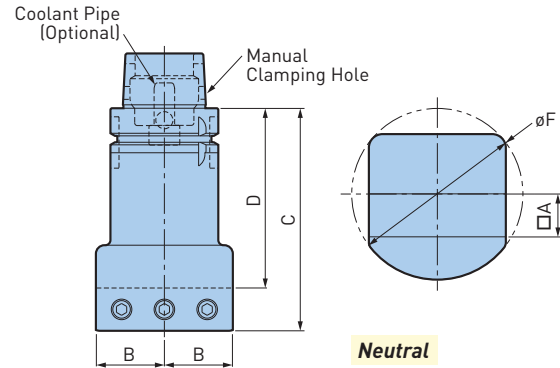
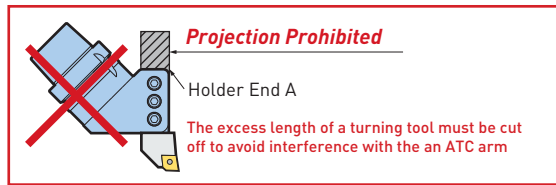

90° (ISO 12164-3)

Catalog Number	Hand	□A	B	C	D	øF
HSK-T63-90-BH20N-85	N	20mm	1.26	3.35	2.36	3.15
-BH25N-100		25mm	1.57	3.94	2.95	3.94
-BH25N-130				5.12	4.13	
HSK-T100-90-BH25N-150	N	25mm	2.17	5.91	4.92	5.04

180°

Catalog Number	Hand	□A	B	C	D	øF
HSK-T63-180-BH20R-120	R	20mm	1.06	4.72	2.76	2.95
-BH20L-120	L					
-BH25R-125	R	25mm	1.16	4.92	3.15	3.54
-BH25L-125	L					
HSK-T100-180-BH25R-140	R	25mm	1.97	5.51	3.54	4.72
-BH25L-140	L					
-BH25R-180	R			7.09	4.53	
-BH25L-180	L					

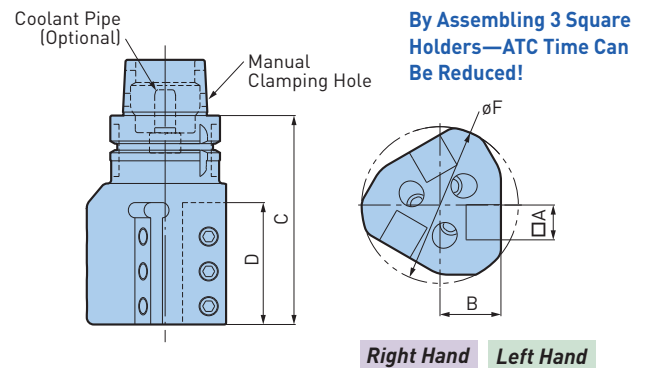

180° Multi Type

Catalog Number	Hand	□A	B	C	D	øF
HSK-T63-180-3BH20R-120	R	20mm	1.38	4.72	2.76	3.54
-3BH20L-120	L					
-3BH25R-125	R	25mm	1.77	4.92	3.15	4.33
-3BH25L-125	L					

CAUTION

60° indexing capability is required for the machine spindle.

BORING BAR HOLDER—HSK-T

CLAMPING RANGE: $\phi 6$ -40mm

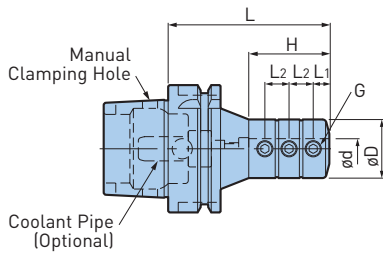
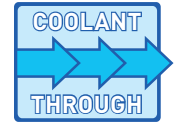

Fig. 1

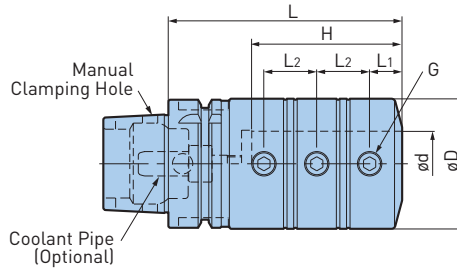

Fig. 2

MILL-TURN A.7

Catalog Number	Fig.	ϕd	ϕD	L	L ₁	L ₂	H	G	Weight (lbs)		
HSK-T63-BSL6-70	1	6mm	.906	2.76	.197	.315	.95	M5 P0.8	2.0		
-BSL8-75		8mm	.984	2.95	.236	.394	1.26	M6 P1.0	2.0		
-BSL10-80		10mm	1.142	3.15	.315	.472	1.58	M8 P1.0	2.0		
-BSL12-85		12mm	1.339	3.35		.630	1.77		2.4		
-BSL16-80❖		2	16mm	1.575	3.15	.394	.827	1.61	M10 P1.25	2.4	
-100					3.94		.827	2.36		2.9	
-BSL20-80❖			20mm	1.969	3.15	.472	.787	1.61		3.1	
-100					3.94		.787	2.36		3.5	
-BSL25-85❖			25mm	2.165	3.35	.551	.906	1.85		M12 P1.5	3.3
-110					4.33		.906	2.64			4.0
-BSL32-90❖	32mm	2.520	3.54	.630	1.024	1.93	M16 P1.5	4.2			
-125			4.92		1.024	2.91		5.7			
-BSL40-105❖			40mm		3.150	4.13		.709	1.260	2.40	M16 P1.5
-145	5.71	1.260		3.58		8.8					
HSK-T100-BSL16-105	1	16mm	1.575	4.13	.394	.827	2.36	M10 P1.25	6.0		
-BSL20-110		20mm	1.969	4.33	.472	.787		M10 P1.25	7.1		
-BSL25-120		25mm	2.165	4.72	.551	.906	2.64	M12 P1.5	7.7		
-BSL32-125		32mm	2.520	4.92	.630	1.024	2.91		8.8		
-BSL40-135		40mm	3.150	5.32	.709	1.260	3.54		M16 P1.5	11.5	

- Plug A and Plug B are included
- Interchangeable between center-through and side-through coolant supply by using plugs
- BSL sleeve cannot be used with models marked ❖

BSL SPARE PARTS—HSK-T

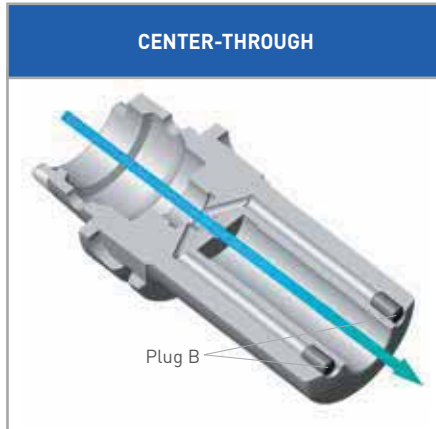

Right or Left Hand
Adjustment is Possible

Catalog Number	Plug A	Plug B
BSL6	M5 P0.8	M4 P0.7
BSL8	M6 P1.0	
BSL10		M6 P1.0❖
BSL12		
BSL16		
BSL20		
BSL25	T63:M6 P1.0❖, T100:M8 P1.25❖	M6 P1.0
BSL32	M8 P1.25❖	
BSL40		

- Plug A and Plug B are included
- Bottom-head bolt with models marked ❖

For BSL Side Lock Holder

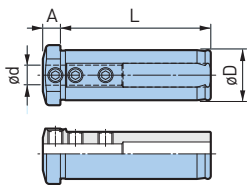

Fig. 1

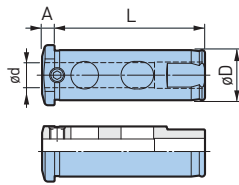

Fig. 2

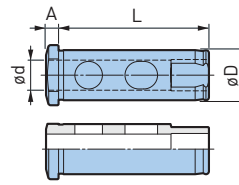
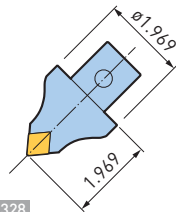

Fig. 3

Catalog Number	Fig.	ød	øD	L	A
BSLA20-6	1	6mm	20mm	2.36	.20
-8		8mm			.28
-10	2	10mm			.20
-12	3	12mm			.20
-16		16mm			.20
BSLA32-10	1	10mm			32mm
-12		12mm	.35		
-16	2	16mm	.24		
-20	3	20mm	.24		

45°

* When using a DN1506 insert (thickness: 6.35mm), replace the standard carbide shim with the DNS1506 (optional)



S TYPE PG. 320
BASIC HOLDER

Catalog Number	L
C5-S50-40	1.57
-55	2.17
-75	2.95
C6-S50-45	1.77
-75	2.95
-100	3.64
C8-S50-135	5.31



S TYPE CARTRIDGE PG. 328

No.1

S50-DCLNN-00050-12

- Cartridge mono-block holders are also available

No.2

S50-DTJNR-00050-16
-DTJNL-00050-16
S50-DTJNR-00050-22
-DTJNL-00050-22

No.3

S50-DDHNN-00050-15

- Cartridge mono-block holders are also available

No.4

S50-DDJNR-00050-15
-DDJNL-00050-15

No.5

S50-SVQBN-00050-16

- Cartridge mono-block holders are also available

90°

* When using a DN1506 insert (thickness: 6.35mm), replace the standard carbide shim with the DNS1506 (optional)

F TYPE PG. 329
CARTRIDGE

Catalog Number	f
F50	1.38
F63	1.77

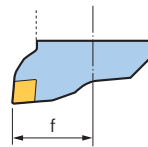

F TYPE PG. 320
BASIC HOLDER

Catalog Number	L
C5-F50-25	.98
-50	1.97
-85	3.35
-125	4.92

F TYPE PG. 320
BASIC HOLDER

Catalog Number	L
C6-F63-30	1.18
-75	2.95
-100	3.94
-130	5.12
-170	6.69
C8-F63-45	1.77
-100	3.94
-130	5.12
-170	6.69



S TYPE PG. 320
BASIC HOLDER

S TYPE PG. 328
CARTRIDGE



- No.1
- No.3
- No.5
- No.8

F TYPE CARTRIDGE PG. 329

No.10

F50-DCLNR-35035-12(16)
-DCLNL-35035-12(16)
F63-DCLNR-45035-12(16)
-DCLNL-45035-12(16)

No.12

F50-DTJNR-35035-16
-DTJNL-35035-16
F63-DTJNR-45035-16
-DTJNL-45035-16

No.13

F50-DDJNR-35035-15
-DDJNL-35035-15
F63-DDJNR-45035-15
-DDJNL-45035-15

MONO BLOCK HOLDER

PG. 321

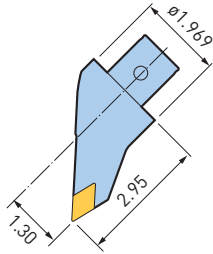

S TYPE PG. 320

BASIC HOLDER

Catalog Number	L
C6-S63-90	3.34
C8-S63-125	4.92

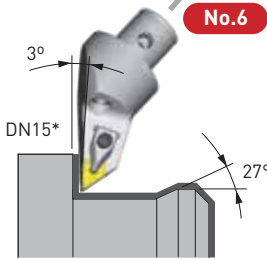
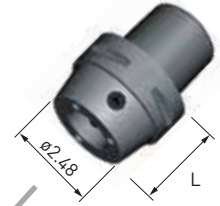
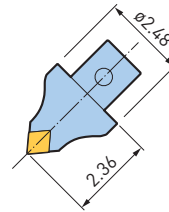

No.6

S50-DDJNR-33075-15
-DDJNL-33075-15

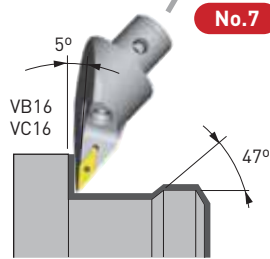

No.7

S50-SVLBR-33075-16
-SVLBL-33075-16

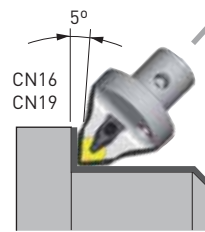

No.8

S63-DCLNN-00060-16
-DCLNN-00060-19

• Cartridge mono-block holders are also available



SQUARE TOOL PG. 322

HOLDERS



SIDE LOCK HOLDER PG. 324

For Boring Bar

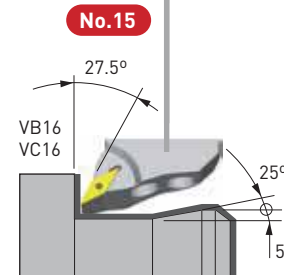

No.15

F63-SVQBR-45035-16
-SVQBL-45035-16

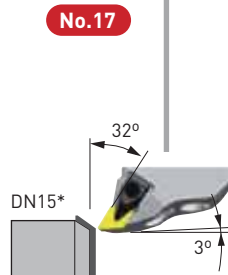

No.17

F63-DDUNR-45035-15
-DDUNL-45035-15

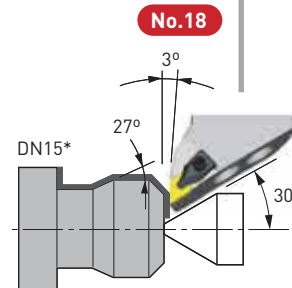

No.18

F50-DDJNR-35050-15
-DDJNL-35050-15
F63-DDJNR-45055-15
-DDJNL-45055-15

BASIC HOLDER—BIG CAPTO Modular Tooling System for Turning Applications

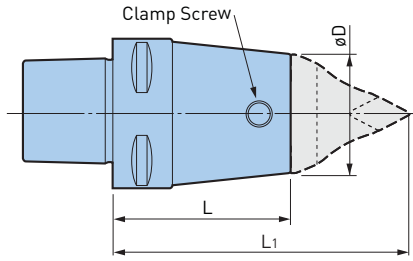

Catalog Number	øD	L	L1	Clamp Screw
C5-S50-40	1.969	1.575	3.54	10.690.435
-55		2.165	4.13	
-75		2.953	4.92	
C6-S50-45	1.969	1.772	3.74	10.690.435
-75		2.953	4.92	
-100		3.937	5.91	
-S63-90	2.480	3.543	5.91	10.690.436
C8-S50-135	1.969	5.315	7.28	10.690.435
-S63-125	2.480	4.921	7.28	10.690.436

ACCESSORIES



- Clamping screw is included

MILL-TURN A.7

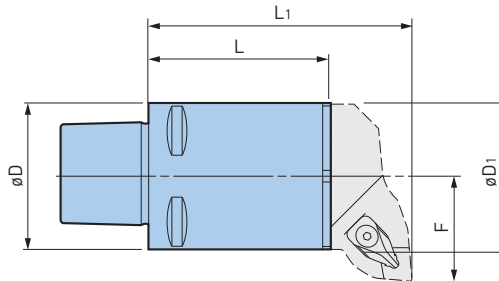

Catalog Number	øD	øD1	L	L1	F
C5-F50-25	1.969	1.969	.984	2.36	1.378
-50			1.969	3.35	
-85			3.345	4.72	
-125			4.921	6.30	
C6-F63-30	2.480	2.480	1.181	2.56	1.772
-75			2.953	4.33	
-100			3.937	5.31	
-130			5.118	6.50	
-170	6.693	8.07			
C8-F63-45	3.150	2.480	1.772	3.15	1.772
-100			3.937	5.31	
-130			5.118	6.50	
-170			6.693	8.07	

ACCESSORIES



- Wrench must be ordered separately
- Basic Holders include M10x22L and M10x25L screws for clamping cartridges
- In case the coolant supply only from 1 of 2 coolant nozzles is required, use the flat head screw (M5 x 102)

INTEGRAL MODEL—BIG CAPTO

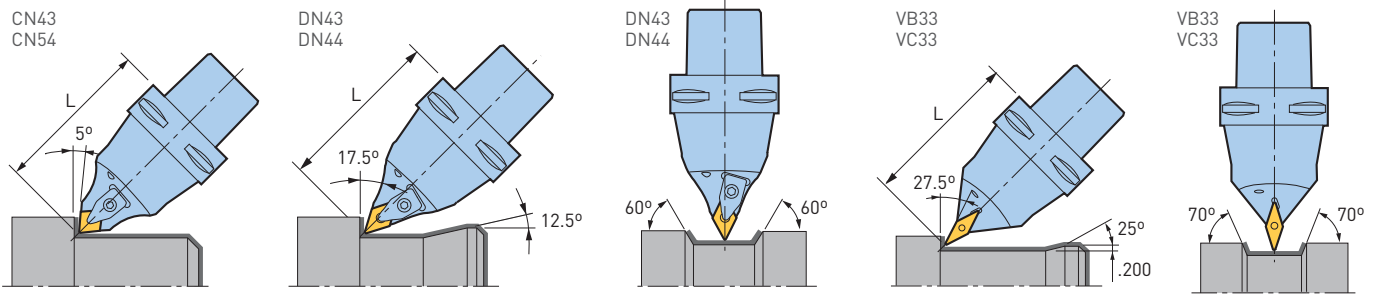

Neutral

Catalog Number	Hand	Insert	L	Clamp Piece
C5-DCLNN-00105-12	N	CN43 Rombic 80°	4.134	CP2
-DCLNN-00105-16		CN54 Rombic 80°		CP3
-DDHNN-00105-15		*DN43/DN44 Rombic 55°		CP2
-SVQBN-00105-16		VB33/VC33 Rombic 35°		**M3.5
C6-DCLNN-00115-12	N	CN43 Rombic 80°	4.528	CP2
-DCLNN-00115-16		CN54 Rombic 80°		CP3
-DDHNN-00115-15		*DN43/DN44 Rombic 55°		CP2
-SVQBN-00115-16		VB33/VC33 Rombic 35°		**M3.5
C8-DCLNN-00150-12	N	CN43 Rombic 80°	5.906	CP2
-DCLNN-00150-16		CN54 Rombic 80°		CP3

*DN43 [3/16" thickness] carbide shim is included as standard, in case of DN44 insert [1/4" thickness], please replace the standard carbide shim with DNS1506 (option)

**M3.5 is screw-on type

- Insert must be ordered separately
- Accepts standard ISO inserts

SQUARE HOLDER—BIG CAPTO

For Square Holder Turning Applications

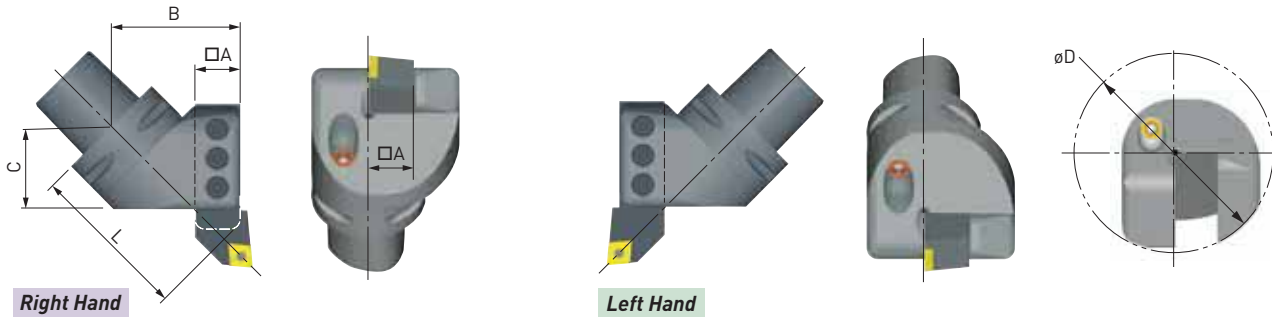

Catalog Number	Hand	□A	B	C	L	øD	Weight (lbs.)
C5-45-BH20R-5838	R	20mm	2.28	1.50	2.87	3.70	2.6
-BH20L-5838	L						
C6-45-BH1.000R-3.25	R	1.000	2.80	1.81	4.33	4.65	5.5
-BH1.000L-3.25	L						
-BH25R-7752	R	25mm	3.03	2.05	3.94	4.65	5.5
-BH25L-7752	L						
C8-45-BH32R-85109	R	32mm	3.35	4.29	5.71	5.31	17.0
-BH32L-85109	L						

CAUTION

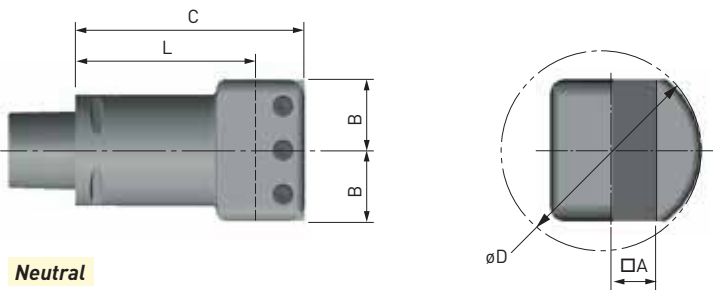
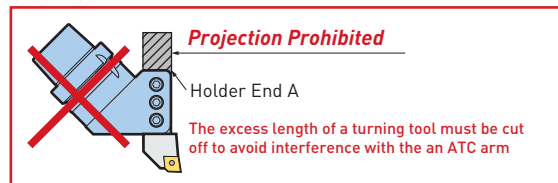

Neutral

Catalog Number	Hand	□A	B	C	L	øD	Weight (lbs.)
C5-90-BH20N-32058	N	20mm	1.26	2.28	1.50	3.15	2.0
-32105				4.13	2.56		4.9
C6-90-BH20N-32060	N	20mm	1.26	2.36	1.57	3.15	5.3
-32115				4.53	3.74		7.5
-BH1.000N-5.125	N	1.000	1.58	5.12	4.12	3.94	9.3
-BH25N-40071				2.80	1.81		7.3
-BH25N-40130	N	25mm	1.57	5.12	4.13	3.94	9.3
C8-90-BH32N-51085				N	32mm		2.01
-51165	6.50	5.24	19.2				

SQUARE HOLDER—BIG CAPTO

For Turning Applications

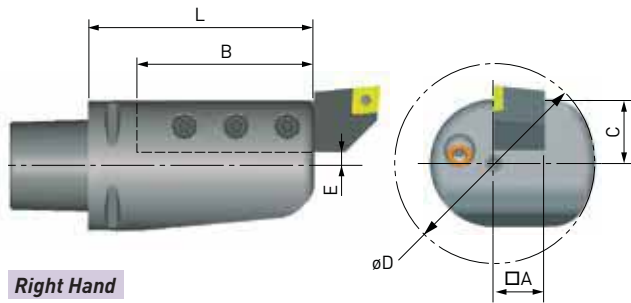

Right Hand

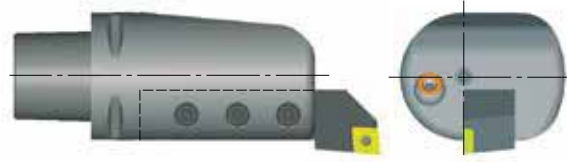

Left Hand

Catalog Number	Hand	□A	C	L	B	E	øD	Weight (lbs.)
C5-180-BH20R-2590	R	20mm	.98	3.54	2.56	.20	3.15	3.5
-BH20L-2590	L							
C6-180-BH1.000R-4.375	R	1.000	1.16	4.33	3.15	.24	3.94	6.8
-BH1.000L-4.375	L							
-BH20R-32100	R	20mm	1.24	3.94	2.56	.45	3.15	5.7
-BH20L-32100	L							
-BH25R-32120S	R	25mm	1.16	4.72	3.15	.18	3.54	6.8
-BH25L-32120S	L							
C8-180-BH32R-40125	R	32mm	1.57	4.92	3.35	.24	5.04	13.2
-BH32L-40125	L							

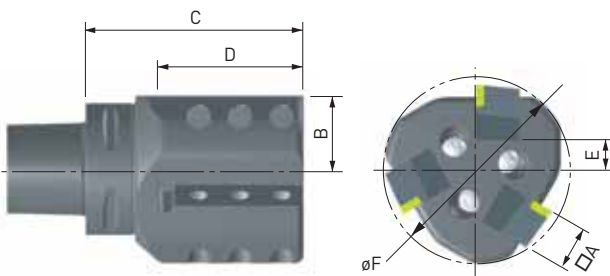

Right Hand

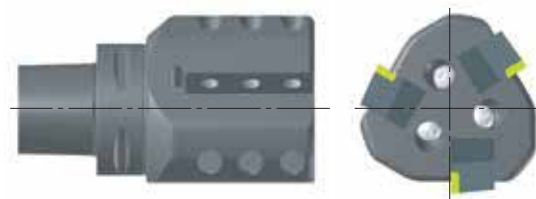

Left Hand

Catalog Number	Hand	□A	B	C	D	E	øF	Weight (lbs.)
C5-180-3BH20R-100	R	20mm	1.38	3.94	2.76	.59	3.54	5.7
-3BH20L-100	L							
C6-180-3BH20R-110	R	20mm	1.38	4.33	2.76	.59	3.54	7.1
-3BH20L-110	L							
-3BH25R-125	R	25mm	1.77	4.91	3.15	.79	4.33	10.1
-3BH25L-125	L							
C8-180-3BH25R-130	R	25mm	1.77	5.12	3.54	.79	4.33	13.4
-3BH25L-130	L							

BORING BAR HOLDER—BIG CAPTO

CLAMPING RANGE: $\phi 6$ -40mm

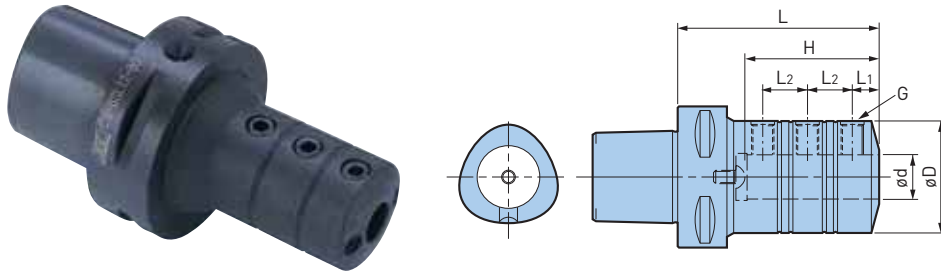
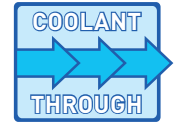

Catalog Number	ϕd	ϕD	L	L1	L2	Bore Depth H	G	Weight (lbs.)
C5-BSL6-70	6mm	.906	2.76	.20	.31	1.61	M5xP0.8	1.3
-BSL8-70	8mm	.984		.24	.39		M6xP1.0	1.3
-BSL10-70	10mm	1.142		.31	.47		M8xP1.0	1.3
-BSL12-80	12mm	1.339	3.15	.31	.63	2.09		1.8
-BSL16-90	16mm	1.575	3.54	.39	.83	2.56	M10xP1.25	2.2
-BSL20-90	20mm	1.969		.47	.79			2.36
-BSL25-100	25mm	2.165	3.94	.55	.91	2.76	M12xP1.5	3.5
-BSL32-110	32mm	2.520	4.33	.63	1.02	3.07		4.6
-BSL40-130	40mm	3.150	5.12	.71	1.26	3.66	M16xP1.5	8.1
C6-BSL.625-3.5	.625	1.575	3.50	.39	.83	2.56	M10xP1.25	3.7
-BSL.750-3.5	.750	1.969		.47	.79			2.36
-BSL1.000-4	1.000	2.165	4.00	.55	.91	2.76	M12xP1.5	5.1
-BSL1.250-4.5	1.250	2.520	4.50	.63	1.02	3.07		6.2
-BSL1.500-5	1.500	3.150	5.00	.71	1.26	3.66	M16xP1.5	9.5
-BSL6-70	6mm	.906	2.76	.20	.31	1.61	M5xP0.8	3.1
-BSL8-70	8mm	.984		.24	.39		M6xP1.0	2.9
-BSL10-70	10mm	1.142		.31	.47		M8xP1.0	2.9
-BSL12-80	12mm	1.339	3.15	.63	2.09	3.3		
-BSL16-90	16mm	1.575	3.54	.39	.83	2.56	M10xP1.25	3.7
-BSL20-90	20mm	1.969	3.94	.47	.87	2.36		4.4
-BSL25-100	25mm	2.165		.55	1.02	2.76	M12xP1.5	5.1
-BSL32-110	32mm	2.520	4.33	.63	1.18	3.07		6.2
-BSL40-130	40mm	3.150	5.12	.71	1.26	3.66	M16xP1.5	9.5
C8-BSL16-90	16mm	1.575	3.54	.39	.83	2.56	M10xP1.25	6.4
-BSL20-100	20mm	1.969	3.94	.47	.87	2.76		7.3
-BSL25-110	25mm	2.165	4.33	.55	1.02	3.15	M12xP1.5	7.9
-BSL32-120	32mm	2.520	4.72	.63	1.18	3.46		9.0
-BSL40-130	40mm	3.150	5.12	.71	1.26	3.66	M16xP1.5	12.1

- Plug A and Plug B are included
- Interchangeable between center-through and side-through coolant supply by using plugs

BSL SPARE PARTS—BIG CAPTO

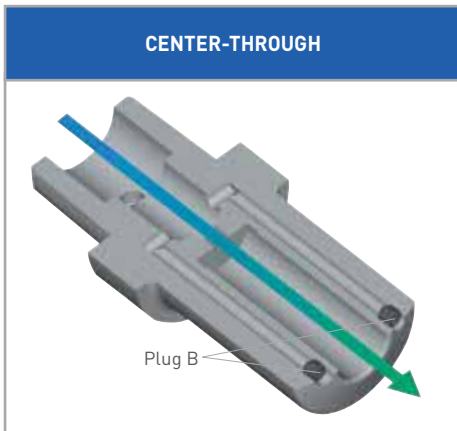
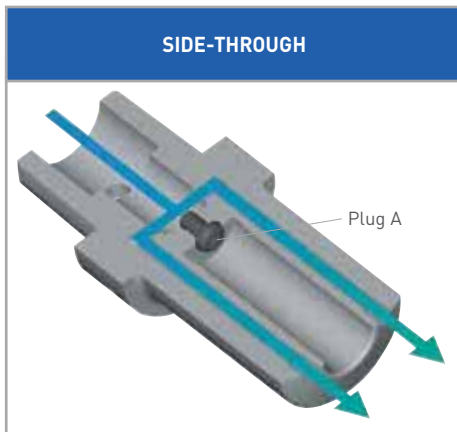

Catalog Number	Plug A	Plug B
BSL.625	M18xP1.5	M6xP1.0
BSL.750	M6xP1.0 ❖	
BSL1.000	M8xP1.25 ❖	
BSL1.250	M8xP1.25 ❖	
BSL1.500	M8xP1.25 ❖	M4xP0.7
BSL6	M8xP1.25	M4xP0.7
BSL8	M10xP1.0	M5xP0.8
BSL10	M12xP1.5	M6xP1.0
BSL12	M14xP1.5	
BSL16	M18xP1.5 (C5: M6xP1.0 ❖)	
BSL20	M6xP1.0 ❖	
BSL25	M6xP1.0 ❖	M8xP1.25 ❖
BSL32	M8xP1.25 ❖	
BSL40	M8xP1.25 ❖	

- Plug A and Plug B are included
- Bottom-head bolt with models marked ❖

A.7 MILL-TURN

For BSL Side Lock Holder

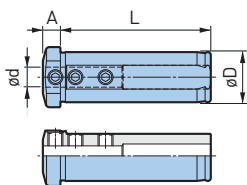

Fig. 1

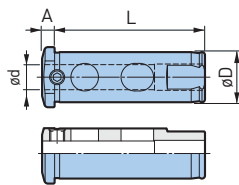

Fig. 2

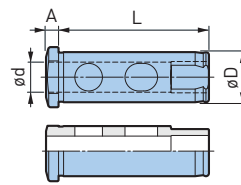
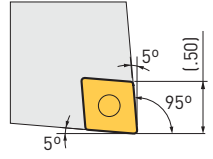
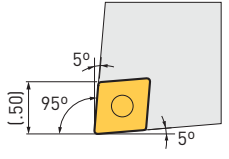
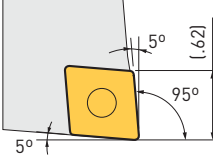
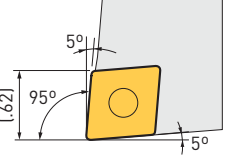
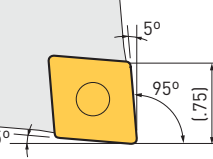
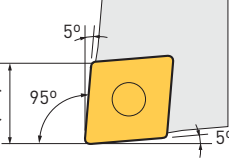
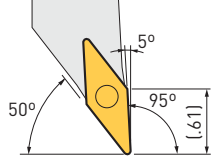
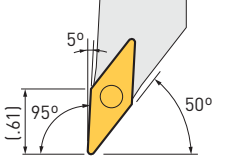
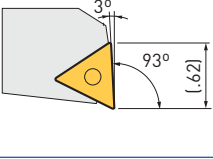
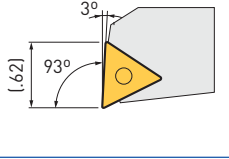
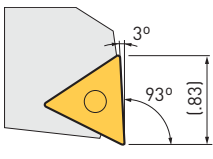
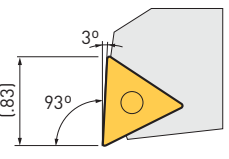

Fig. 3

Catalog Number	Fig.	ød	øD	L	A
BSLA20-6	1	6mm	20mm	2.36	.20
-8		8mm			.28
-10	2	10mm			.20
-12	3	12mm			.20
-16		16mm			.20
BSLA32-10	1	10mm			32mm
-12		12mm	.35		
-16	2	16mm	.24		
-20	3	20mm	.24		

SELECTION GUIDE

Entering Angle	Insert	Cartridge		Right hand	Left hand
		S Type	F Type		
95°	CN1204	No.1	No.10-1		
	CN1606	No.8-1	No.10-2		
	CN1906	No.8-2			
	VB1604 VC1604	No.7			
93°	TN1604	No.2-1	No.12		
	TN2204	No.2-2			

MILL-TURN A.7

SELECTION GUIDE

Entering Angle	Insert	Cartridge		Right hand	Left hand
		S Type	F Type		
93°	DN1504 (DN1506)	No.4	No.13		
	DN1504 (DN1506)	No.6	No.18		
107.5°	DN1504 (DN1506)	No.3			
117.5°	VB1604 VC1604	No.5	No.15		
93°	DN1504 (DN1506)		No.17		

A.7 MILL-TURN

Neutral				
CN12	CN16	CN19	DN1504 (DN1506)	VB1604 / VC1604
No.1	No.8-1	No.8-2	No.3	No.5

CARTRIDGES—45° TYPE S

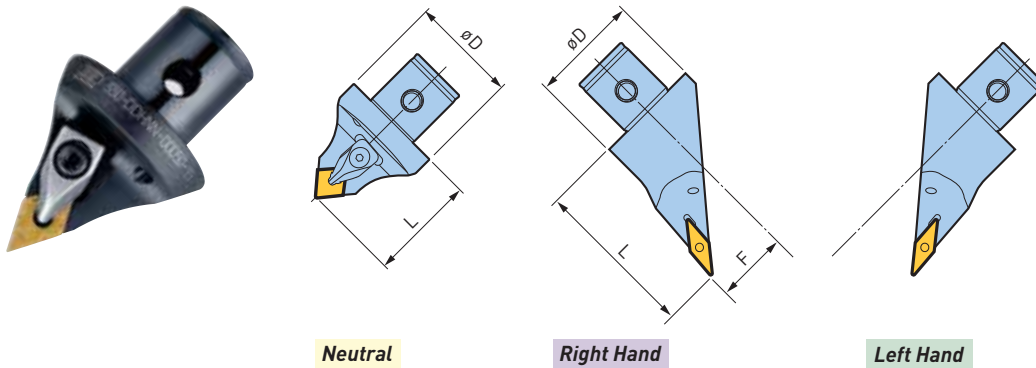

Neutral

Right Hand

Left Hand

Lead Angle	Type	Catalog Number	Hand	Insert	L	F	øD	Clamp Piece		
5°	S50	S50-DCLNN-00050-12	N	CN43 Rhombic 80°	1.97	0	1.97	CP2		
	S63	S63-DCLNN-00060-16		CN54 Rhombic 80°	2.36			CP3		
		S63-DCLNN-00060-19		CN64 Rhombic 80°				CP5		
3°	S50	S50-DTJNR-00050-16	R	TN33 Triangle 60°	1.97	0	1.97	CP1		
		-DTJNL-00050-16	L					TN43 Triangle 60°	CP2	
		-DTJNR-00050-22	R	*					2.95	1.30
		-DTJNL-00050-22	L							
3°	S50	S50-DDJNR-00050-15	R	* DN43 DN44 Rhombic 55°	1.97	0	1.97	CP2		
		-DDJNL-00050-15	L		2.95				1.30	
		-DDJNR-33075-15	R							
		-DDJNL-33075-15	L							
17.5°	S50	S50-DDHNN-00050-15	N		1.97	0				
5°	S50	S50-SVLBR-33075-16	R	VB33 VC33 Rhombic 35°	2.95	1.30	1.97	** M3.5		
		-SVLBL-33075-16	L							
27.5°	S50	S50-SVQBN-00050-16	N		1.97	0				

*DN43 (3/16" thickness) carbide shim is included as standard, in case of DN44 insert (1/4" thickness), please replace the standard carbide shim with DNS1506 (option)

**M3.5 is screw-on type

- Wrench and insert must be ordered separately
- Accepts standard ISO inserts

ACCESSORIES

CLAMP PIECE PG. 330	SCREW PG. 330	SPRING PG. 330	CLAMP SCREW SET PG. 331	INSERT CLAMPING SCREW SET PG. 331
------------------------	------------------	-------------------	-------------------------------	---

MILL-TURN A.7

CARTRIDGES—90° TYPE F

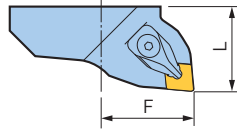

Right Hand

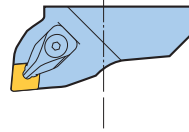

Left Hand

Lead Angle	Type	Catalog Number	Hand	Insert	L	F	Clamp Piece
5°	F50	F50-DCLNR-35035-12	R	CN43 Rhombic 80°	1.38	1.38	CP2
	F63	F63-DCLNR-45035-12	R			1.77	
	F50	F50-DCLNL-35035-12	L			1.38	
	F63	F63-DCLNL-45035-12	L			1.77	
	F50	F50-DCLNR-35035-16	R	CN54 Rhombic 80°	1.38	1.38	CP3
	F63	F63-DCLNR-45035-16	R			1.77	
	F50	F50-DCLNL-35035-16	L			1.38	
	F63	F63-DCLNL-45035-16	L			1.77	
3°	F50	F50-DTJNR-35035-16	R	TN33 Triangle 60°	1.38	1.38	CP1
	F63	F63-DTJNR-45035-16	R			1.77	
	F50	F50-DTJNL-35035-16	L			1.38	
	F63	F63-DTJNL-45035-16	L			1.77	
3°	F50	F50-DDJNR-35035-15	R	* DN43 DN44 Rhombic 55°	1.38	1.38	CP2
	F63	F63-DDJNR-45035-15	R			1.77	
	F50	F50-DDJNL-35035-15	L			1.38	
	F63	F63-DDJNL-45035-15	L			1.77	
	F50	F50-DDJNR-35050-15	R	1.97	1.38	CP2	
	F63	F63-DDJNR-45055-15	R	2.17	1.77		
	F50	F50-DDJNL-35050-15	L	1.97	1.38		
	F63	F63-DDJNL-45055-15	L	2.17	1.77		
32°	F63	-DDUNR-45035-15	R	1.38	1.77	CP2	
		-DDUNL-45035-15	L				
27.5°	F63	F63-SVQBR-45035-16	R	VB33 VC33 Rhombic 35°	1.38	1.77	**M3.5
	F63	F63-SVQBL-45035-16	L			1.77	

*DN43 (3/16" thickness) carbide shim is included as standard, in case of DN44 insert (1/4" thickness), please replace the standard carbide shim with DNS1506 (option)

**M3.5 is screw-on type

- Wrench and insert must be ordered separately,
- Accepts standard ISO inserts

ACCESSORIES



<p>CLAMP PIECE PG. 330</p>	<p>SCREW PG. 330</p>	<p>SPRING PG. 330</p>	<p>CLAMP SCREW SET PG. 331</p>	<p>INSERT CLAMPING SCREW SET PG. 331</p>
--------------------------------	--------------------------	---------------------------	------------------------------------	--

A.7 MILL-TURN

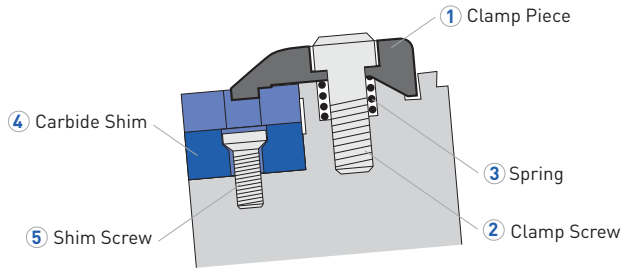
DOUBLE CLAMP TYPE



CARBIDE CLAMP SET

Catalog Number	Clamp Piece (1) 	Screw (2) 	Spring (3) 	Insert
SCP1	CP1	M5x20	ø8x10	TN33
SCP2	CP2			CN43, TN43, DN43, DN44
SCP3	CP3			CN54, TN54
SCP5	CP5			CN64

• Clamp piece, screw and spring are included, wrench must be ordered separately (Model: T-4)

CARBIDE SHIM SET

Catalog Number	Carbide Shim (4)	Screw (5) 	Torx Size	Insert
STNS1604	TNS1604	M3x7	T10	TN33
STNS2204	TNS2204	M4x8	T15	TN43
STNS2706	TNS2706	M5x12	T20	TN54
SDNS1504	DNS1504	M4x8	T15	DN43
SDNS1506	DNS1506	M4x8	T15	DN44
SCNS1204	CNS1204	M4x8	T15	CN43
SCNS1606	CNS1606	M5x12	T20	CN54
SCNS1906	CNS1906	M5x12	T20	CN64
SWNS0804	WNS0804	M4x8	T15	WN43

• Carbide shim and screw are included, wrench must be ordered separately (Model: DA-T10, DA-T15, DA-T20)

CLAMP SCREW SET

For Type S Basic Holder

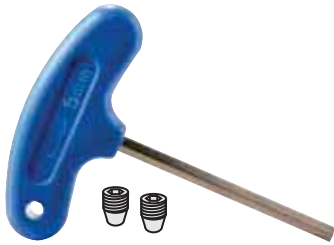

Catalog Number	Type	Screw Size	Wrench Model
10.690.435	S50	M10x1.0	10.690.816
10.690.436	S63	M12x1.0	10.690.817

INSERT CLAMPING SCREW SET

For VB33/VC33 Inserts



Catalog Number
S3508DS

Contents

- M3.5 screws 10 pcs.
- Wrench **DA-T15** 1 pc.

TOOL HOLDER ACCESSORIES

A.8

TOOL HOLDER ACCESSORIES A.8



MEGA MICRO CHUCK



MICRO COLLET
MICRO COLLET SET
MEGA MICRO COOLANT NUT
MEGA MICRO NUT
MEGA MICRO SEAL NUT
 α TAPER CLEANER
MEGA WRENCH
MEGA TORQUE WRENCH

PG. 334

PG. 336

PG. 368

MEGA E CHUCK

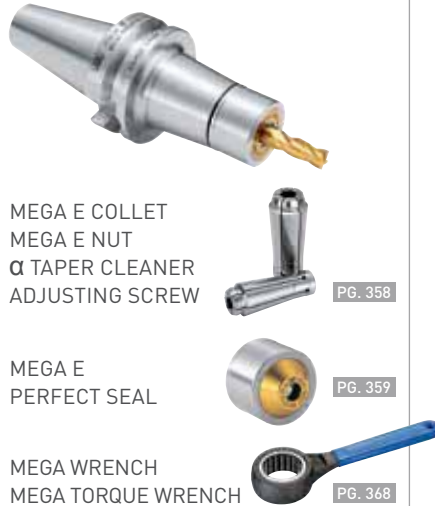

MEGA E COLLET
MEGA E NUT
 α TAPER CLEANER
ADJUSTING SCREW
MEGA E
PERFECT SEAL
MEGA WRENCH
MEGA TORQUE WRENCH

PG. 358

PG. 359

PG. 368

HYDRAULIC CHUCK



PJC STRAIGHT COLLET
PSC STRAIGHT COLLET
GRIP BAR FOR CONFIRMING
GRIPPING FORCE

PG. 361

PG. 373

MEGA NEW BABY CHUCK



NBC NEW BABY COLLET
COLLET SET/COLLET CASE
NEW BABY ENDMILL COLLET
FONBC COOLANT COLLET
MEGA NEW BABY NUT
MEGA PERFECT SEAL
ADJUSTING SCREW
COLLET EJECTOR
COLLET REMOVER
 α TAPER CLEANER
MEGA WRENCH
MEGA TORQUE WRENCH

PG. 338

PG. 346

PG. 389

PG. 351

PG. 368

MEGA DOUBLE POWER CHUCK



PJC STRAIGHT COLLET
PSC STRAIGHT COLLET
AXIAL ADJUSTING SCREW
MEGA WRENCH

PG. 362

PG. 368

NEW Hi-POWER MILLING CHUCK



PJC STRAIGHT COLLET
PSC STRAIGHT COLLET
C STRAIGHT COLLET
OCA STRAIGHT COLLET
AXIAL ADJUSTING SCREW
FACE MILL ARBOR
JACOBS TAPER ARBOR
MORSE TAPER HOLDER
WRENCH

PG. 361

PG. 366

PG. 367

NEW BABY CHUCK



NBC NEW BABY COLLET
COLLET SET/COLLET CASE
BABY PERFECT SEAL
ADJUSTING SCREW
COLLET EJECTOR
COLLET REMOVER
 α TAPER CLEANER
NEW BABY WRENCH
TORQUE WRENCH

PG. 338

PG. 348

PG. 389

PG. 351

PG. 350

MEGA ER GRIP



ERC COLLET
ERC END MILL COLLET
MEGA ER NUT
MEGA ER SOLID NUT
ER NUT
MEGA ER
PERFECT SEAL
ADJUSTING SCREW
MEGA WRENCH

PG. 352

PG. 356

PG. 389

PG. 368

MEGA SYNCHRO TAPPING HOLDERS



TAP HOLDERS

PG. 374

MEGA MICRO COLLET

Available in .004 (0.1mm) diameter increments to suit all cutting tool shank sizes with maximum accuracy. Despite their compact size, high clamping force and accuracy are achieved.

**HIGH
PRECISION**

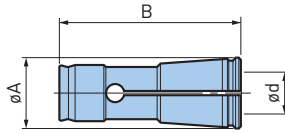

Guaranteed Max Runout

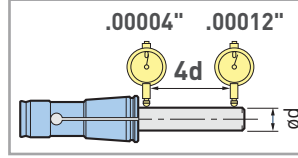

All BIG Collets are AA Grade and inspected twice for accuracy

MEGA 3S

Catalog Number	Clamping Range ød
NBC3S-0.5AA	.018-.022
-0.6AA	.022-.026
-0.7AA	.026-.030
-0.8AA	.030-.033
-0.9AA	.033-.037
-1AA	.037-.041
-1.1AA	.041-.045
-1.2AA	.045-.049
-1.3AA	.049-.053
-1.4AA	.053-.057
-1.5AA	.057-.061
-1.6AA	.061-.065
-1.7AA	.065-.069
-1.8AA	.069-.073
-1.9AA	.073-.077
-2AA	.077-.081
-2.1AA	.081-.085
-2.2AA	.085-.089
-2.3AA	.089-.093
-2.4AA	.093-.096
-2.5AA	.096-.100
-2.6AA	.100-.104
-2.7AA	.104-.108
-2.8AA	.108-.112
-2.9AA	.112-.116
-3AA	.116-.120
-3.1AA	.120-.124
-3.175AA	.123-.127
-3.2AA	.124-.128

øA=.24 (6.06mm) B=.75 (18.8mm)

MEGA 4S

Catalog Number	Clamping Range ød
NBC4S-0.5AA	.018-.022
-0.6AA	.022-.026
-0.7AA	.026-.030
-0.8AA	.030-.033
-0.9AA	.033-.037
-1AA	.037-.041
-1.1AA	.041-.045
-1.2AA	.045-.049
-1.3AA	.049-.053
-1.4AA	.053-.057
-1.5AA	.057-.061
-1.6AA	.061-.065
-1.7AA	.065-.069
-1.8AA	.069-.073
-1.9AA	.073-.077
-2AA	.077-.081
-2.1AA	.081-.085
-2.2AA	.085-.089
-2.3AA	.089-.093
-2.4AA	.093-.096
-2.5AA	.096-.100
-2.6AA	.100-.104
-2.7AA	.104-.108
-2.8AA	.108-.112
-2.9AA	.112-.116
-3AA	.116-.120
-3.1AA	.120-.124
-3.175AA	.123-.127
-3.2AA	.124-.128
-3.3AA	.128-.132
-3.4AA	.132-.136
-3.5AA	.136-.140
-3.6AA	.140-.144
-3.7AA	.144-.148
-3.8AA	.148-.152
-3.9AA	.152-.156
-4AA	.156-.159

øA=.29 (7.4mm) B=.89 (22.5mm)

MEGA 6S

Catalog Number	Clamping Range ød
NBC6S-0.5AA	.018-.022
-0.6AA	.022-.026
-0.7AA	.026-.030
-0.8AA	.030-.033
-0.9AA	.033-.037
-1AA	.037-.041
-1.1AA	.041-.045
-1.2AA	.045-.049
-1.3AA	.049-.053
-1.4AA	.053-.057
-1.5AA	.057-.061
-1.6AA	.061-.065
-1.7AA	.065-.069
-1.8AA	.069-.073
-1.9AA	.073-.077
-2AA	.077-.081
-2.1AA	.081-.085
-2.2AA	.085-.089
-2.3AA	.089-.093
-2.4AA	.093-.096
-2.5AA	.096-.100
-2.6AA	.100-.104
-2.7AA	.104-.108
-2.8AA	.108-.112
-2.9AA	.112-.116
-3AA	.116-.120
-3.1AA	.120-.124
-3.175AA	.123-.127
-3.2AA	.124-.128
-3.3AA	.128-.132
-3.4AA	.132-.136
-3.5AA	.136-.140
-3.6AA	.140-.144
-3.7AA	.144-.148
-3.8AA	.148-.152
-3.9AA	.152-.156
-4AA	.156-.159

Catalog Number	Clamping Range ød
NBC6S-4.1AA	.159-.163
-4.2AA	.163-.167
-4.3AA	.167-.171
-4.4AA	.171-.175
-4.5AA	.175-.179
-4.6AA	.179-.183
-4.7AA	.183-.187
-4.7625AA	.186-.189
-4.8AA	.187-.191
-4.9AA	.191-.195
-5AA	.195-.199
-5.1AA	.199-.203
-5.2AA	.203-.207
-5.3AA	.207-.211
-5.4AA	.211-.215
-5.5AA	.215-.219
-5.6AA	.219-.222
-5.7AA	.222-.226
-5.8AA	.226-.230
-5.9AA	.230-.234
-6AA	.234-.238

øA=.37 (9.4mm) B=.96 (24.5mm)

MEGA 85

Catalog Number	Clamping Range ød	Catalog Number	Clamping Range ød
NBC85-3AA	.116-.120	-5.9AA	.230-.234
-3.1AA	.120-.124	NBC85-6AA	.234-.238
-3.175AA	.123-.127	-6.1AA	.238-.242
-3.2AA	.124-.128	-6.2AA	.242-.246
-3.3AA	.128-.132	-6.3AA	.246-.250
-3.4AA	.132-.136	-6.4AA	.250-.254
-3.5AA	.136-.140	-6.5AA	.254-.258
-3.6AA	.140-.144	-6.6AA	.258-.262
-3.7AA	.144-.148	-6.7AA	.262-.266
-3.8AA	.148-.152	-6.8AA	.266-.270
-3.9AA	.152-.156	-6.9AA	.270-.274
-4AA	.156-.159	-7AA	.274-.278
-4.1AA	.159-.163	-7.1AA	.278-.281
-4.2AA	.163-.167	-7.2AA	.281-.285
-4.3AA	.167-.171	-7.3AA	.285-.289
-4.4AA	.171-.175	-7.4AA	.289-.293
-4.5AA	.175-.179	-7.5AA	.293-.297
-4.6AA	.179-.183	-7.6AA	.297-.301
-4.7AA	.183-.187	-7.7AA	.301-.305
-4.8AA	.187-.191	-7.8AA	.305-.309
-4.9AA	.191-.195	-7.9AA	.309-.313
-5AA	.195-.199	-8AA	.313-.317
-5.1AA	.199-.203		
-5.2AA	.203-.207		
-5.3AA	.207-.211		
-5.4AA	.211-.215		
-5.5AA	.215-.219		
-5.6AA	.219-.222		
-5.7AA	.222-.226		
-5.8AA	.226-.230		

øA=.47 (12mm) B=1.06 (27mm)

MEGA MICRO COOLANT NUT (PAT. PENDING)

For MEGA MICRO CHUCK 6S provides a more efficient coolant supply for micro cutting tools. Ideal design for high-speed micro machining up to $\phi 6\text{mm}$.

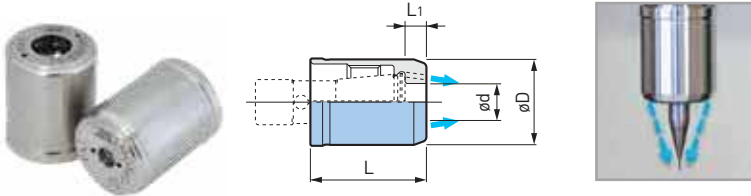

Up to 35% higher tool lifetime compared to standard nut.

MEGA 6S

Catalog Number	ød	øD	L	L1
MGN6S-2J	2mm	.55 (14mm)	.75 (19mm)	.14 (3.5mm)
-3J	3mm			
-4J	4mm			
-5J	5mm		.67 (17mm)	.06 (1.5mm)
-6J	6mm			

MEGA MICRO SEAL NUT

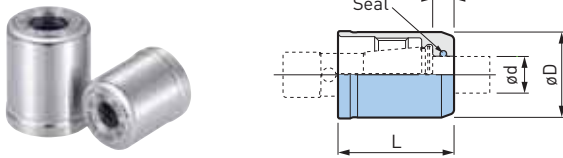

MEGA 6S

Catalog Number	ød	øD	L	L1
MGN6S-PS3	3mm	.55 (14mm)	.75 (19mm)	.14 (3.5mm)
-PS3.175	.125			
-PS4	4mm			
-PS5	5mm			
-PS6	6mm			

MEGA 8S

Catalog Number	ød	øD	L	L1
MGN8S-PS3	3mm	.71 (18mm)	.80 (20.2mm)	.14 (3.5mm)
-PS4	4mm			
-PS5	5mm			
-PS6	6mm			
-PS7	7mm			
-PS8	8mm			

MEGA MICRO NUT

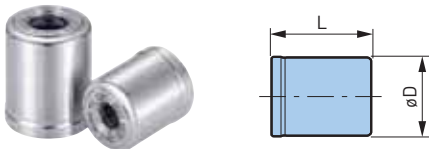

Catalog Number	øD	L	Body Type
MGN3S	.39 (10mm)	.51 (13mm)	MEGA3S
MGN4S	.47 (12mm)	.57 (14.5mm)	MEGA4S
MGN6S	.55 (14mm)	.67 (17mm)	MEGA6S
MGN8S	.71 (18mm)	.73 (18.5mm)	MEGA8S

COLLET CASE

For MEGA MICRO CHUCK. Organizes collet management and ideal for maintaining collet precision.



Catalog Number	Compatible Micro Collet	Number of Holes	Case Size (LxWxH)
NBB3S	NBC3S	50	7.8 x 6.7 x 1.97 (200mm x 170mm x 50mm)
NBB4S	NBC4S		
NBB6S	NBC6S	60	
NBB8S	NBC8S		

- Case size includes handle

α TAPER CLEANER

for MEGA MICRO CHUCK. Removes particles and oil from the chuck bore taper.

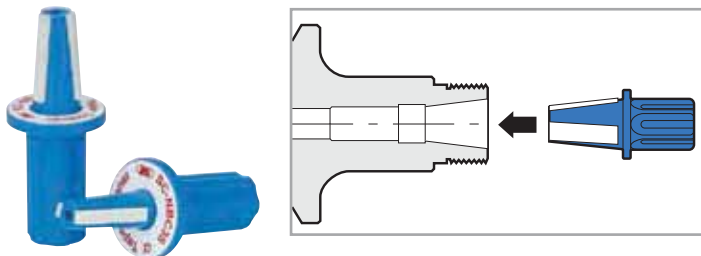

Catalog Number	Chuck Body
SC-NBC3S	MEGA3S
SC-NBC4S	MEGA4S
SC-NBC6S	MEGA6S
SC-NBC8S	MEGA8S

NEW BABY COLLET

The New Baby Collet is world renowned for its unmatched accuracy and precision. It offers runout accuracy of .00004 (.001mm) T.I.R. at the collet nose.

**HIGH
PRECISION**

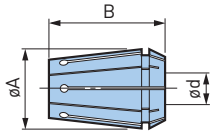

Guaranteed Max Runout

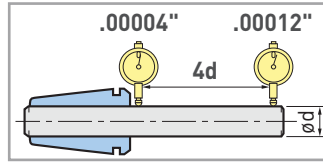

All BIG Collets are AA Grade and inspected twice for accuracy

MEGA 6N/NBS6

Catalog Number	Clamping Range ød
NBC6-0.5AA	.010-.020
-0.75AA	.020-.030
-1AA	.030-.039
-1.25AA	.039-.049
-1.5AA	.049-.059
-1.75AA	.059-.069
-2AA	.069-.079
-2.25AA	.079-.089
-2.5AA	.089-.098
-2.75AA	.098-.108
-3AA	.108-.118
-3.175AA	.115-.125
-3.25AA	.118-.128
-3.5AA	.128-.138
-3.75AA	.138-.148
-4AA	.148-.157
-4.25AA	.157-.167
-4.5AA	.167-.177
-4.75AA	.177-.187
-5AA	.187-.197
-5.25AA	.197-.207
-5.5AA	.207-.217
-5.75AA	.217-.226
-6AA	.226-.236

øA=.37 (9.5mm) B=.55 (14mm)

MEGA 8N/NBS8

Catalog Number	Clamping Range ød
NBC8-0.75AA	.020-.030
-1AA	.030-.039
-1.25AA	.039-.049
-1.5AA	.049-.059
-1.75AA	.059-.069
-2AA	.069-.079
-2.25AA	.079-.089
-2.5AA	.089-.098
-2.75AA	.098-.108
-3AA	.108-.118
-3.175AA	.115-.125
-3.5AA	.118-.138
-4AA	.138-.157
-4.5AA	.157-.177
-5AA	.177-.197
-5.25AA	.187-.207
-5.5AA	.197-.217
-5.75AA	.207-.226
-6AA	.217-.236
-6.5AA	.236-.256
-7AA	.256-.276
-7.5AA	.276-.295
-8AA	.295-.315

øA=.49 (12.5mm) B=.71 (18mm)

MEGA 10N/NBS10

Catalog Number	Clamping Range ød
NBC10-1.75AA	.059-.069
-2AA	.069-.079
-2.25AA	.079-.089
-2.5AA	.089-.098
-2.75AA	.098-.108
-3AA	.108-.118
-3.175AA	.115-.125
-3.5AA	.118-.138
-4AA	.138-.157
-4.5AA	.157-.177
-5AA	.177-.197
-5.25AA	.187-.207
-5.5AA	.197-.217
-5.75AA	.207-.226
-6AA	.217-.236
-6.5AA	.236-.256
-7AA	.256-.276
-7.5AA	.276-.295
-8AA	.295-.315
-8.5AA	.315-.335
-9AA	.335-.354
-9.5AA	.354-.375
-10AA	.376-.394

øA=.65 (16.5mm) B=1.06 (27mm)

MEGA 13N/NBS13

Catalog Number	Clamping Range ød
NBC13-3AA	.098-.118
-3.175AA	.115-.125
-3.5AA	.118-.138
-4AA	.138-.157
-4.5AA	.157-.177
-5AA	.177-.197
-5.25AA	.187-.207
-5.5AA	.197-.217
-5.75AA	.207-.226
-6AA	.217-.236
-6.5AA	.236-.256
-7AA	.256-.276
-7.5AA	.276-.295
-8AA	.295-.315
-8.5AA	.315-.335
-9AA	.335-.354
-9.5AA	.354-.375
-10AA	.376-.394
-10.5AA	.394-.413
-11AA	.413-.433
-11.5AA	.433-.453
-12AA	.453-.472
-12.5AA	.472-.492
-13AA	.492-.512

øA=.81 (20.5mm) B=1.22 (31mm)

MEGA 16N/NBS16

Catalog Number	Clamping Range ϕ d
NBC16-3AA	.098-.118
-3.5AA	.118-.138
-4AA	.138-.157
-4.5AA	.157-.177
-5AA	.177-.197
-5.25AA	.187-.207
-5.5AA	.197-.217
-5.75AA	.207-.226
-6AA	.217-.236
-6.5AA	.236-.256
-7AA	.256-.276
-7.5AA	.276-.295
-8AA	.295-.315
-8.5AA	.315-.335
-9AA	.335-.354
-9.5AA	.354-.375
-10AA	.376-.394
-10.5AA	.394-.413
-11AA	.413-.433
-11.5AA	.433-.453
-12AA	.453-.472
-12.5AA	.472-.492
-13AA	.492-.512
-13.5AA	.512-.531
-14AA	.531-.551
-14.5AA	.551-.571
-15AA	.571-.591
-15.5AA	.591-.610
-16AA	.610-.630

ϕ A=1.00 (25.5mm) B=1.38 (35mm)

MEGA 20N/NBS20

Catalog Number	Clamping Range ϕ d
NBC20-3AA	.098-.118
-3.5AA	.118-.138
-4AA	.138-.157
-4.5AA	.157-.177
-5AA	.177-.197
-5.25AA	.187-.207
-5.5AA	.197-.217
-5.75AA	.207-.226
-6AA	.217-.236
-6.5AA	.236-.256
-7AA	.256-.276
-7.5AA	.276-.295
-8AA	.295-.315
-8.5AA	.315-.335
-9AA	.335-.354
-9.5AA	.354-.375
-10AA	.376-.394
-10.5AA	.394-.413
-11AA	.413-.433
-11.5AA	.433-.453
-12AA	.453-.472
-12.5AA	.472-.492
-13AA	.492-.512
-13.5AA	.512-.531
-14AA	.531-.551
-14.5AA	.551-.571
-15AA	.571-.591
-15.5AA	.591-.610
-16AA	.610-.630
-16.5AA	.630-.650
-17AA	.650-.669
-17.5AA	.669-.689
-18AA	.689-.709
-18.5AA	.709-.728
-19AA	.728-.750
-19.5AA	.751-.768
-20AA	.768-.787

ϕ A=1.12 (28.5mm) B=1.50 (38mm)

MEGA 25N

Catalog Number	Clamping Range ϕ d
NBC25-16AA	.610-.630
-16.5AA	.630-.650
-17AA	.650-.669
-17.5AA	.669-.689
-18AA	.689-.709
-18.5AA	.709-.728
-19AA	.728-.748
-19.5AA	.748-.768
-20AA	.768-.787
-20.5AA	.787-.807
-21AA	.807-.827
-21.5AA	.827-.846
-22AA	.846-.866
-22.5AA	.866-.886
-23AA	.886-.906
-23.5AA	.906-.925
-24AA	.925-.945
-24.5AA	.945-.964
-25AA	.964-.984
-25.4AA	.980-1.000

ϕ A=1.40 (35.5mm) B=2.05 (52mm)

CAUTION 

Collapsibility is .010 (.25mm) for NBC6 and .020 (.5mm) for NBC8-NBC20. For best performance, cutting tool shanks should be cylindrical without flats and be as long as the clamping section of the collet bore.

NEW BABY END MILL COLLET

The New Baby Collet is world renowned for its unmatched accuracy and precision. It offers runout accuracy of .00004 (.001mm) T.I.R. at the collet nose.

**HIGH
PRECISION**

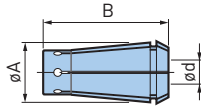

Guaranteed Max Runout

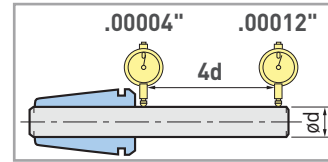

All BIG Collets are AA Grade and inspected twice for accuracy

MEGA 6N/NBS6

Catalog Number	Clamping Range ød
NBC6-1/8EAA	.125
-3/16EAA	.187
-3EAA	3.0mm
-4EAA	4.0mm
-5EAA	5.0mm
-6EAA	6.0mm

øA=.36 (9.2mm) B=.67 (17mm)

MEGA 8N/NBS8

Catalog Number	Clamping Range ød
NBC8-1/8EAA	.125
-3/16EAA	.187
-1/4EAA	.250
-3EAA	3.0mm
-4EAA	4.0mm
-5EAA	5.0mm
-6EAA	6.0mm
-8EAA	8.0mm

øA=.47 (12mm) B=.79 (20mm)

MEGA 10N/NBS10

Catalog Number	Clamping Range ød
NBC10-1/8EAA	.125
-3/16EAA	.187
-1/4EAA	.250
-3/8EAA	.375
-3EAA	3.0mm
-4EAA	4.0mm
-5EAA	5.0mm
-6EAA	6.0mm
-8EAA	8.0mm
-10EAA	10.0mm

øA=.63 (16mm) B= 1.26 (32mm)

MEGA 13N/NBS13

Catalog Number	Clamping Range ød
NBC13-1/8EAA	.125
-3/16EAA	.187
-1/4EAA	.250
-3/8EAA	.375
-1/2EAA	.500
-3EAA	3.0mm
-4EAA	4.0mm
-5EAA	5.0mm
-6EAA	6.0mm
-8EAA	8.0mm
-10EAA	10.0mm
-12EAA	12.0mm

øA=.79 (20mm) B=1.50 (38mm)

MEGA 16N/NBS16

Catalog Number	Clamping Range ød
NBC16-1/8EAA	.125
-3/16EAA	.187
-1/4EAA	.250
-3/8EAA	.375
-1/2EAA	.500
-5/8EAA	.625
-3EAA	3.0mm
-4EAA	4.0mm
-5EAA	5.0mm
-6EAA	6.0mm
-8EAA	8.0mm
-10EAA	10.0mm
-12EAA	12.0mm
-14EAA	14.0mm
-16EAA	16.0mm

øA=.98 (25mm) B=1.65 (42mm)

MEGA 20N/NBS20

Catalog Number	Clamping Range ød
NBC20-1/8EAA	.125
-3/16EAA	.187
-1/4EAA	.250
-3/8EAA	.375
-1/2EAA	.500
-5/8EAA	.625
-3/4EAA	.750
-3EAA	3.0mm
-4EAA	4.0mm
-5EAA	5.0mm
-6EAA	6.0mm
-8EAA	8.0mm
-10EAA	10.0mm
-12EAA	12.0mm
-14EAA	14.0mm
-16EAA	16.0mm
-20EAA	20.0mm

øA=1.10 (28mm) B=1.77 (45mm)

CAUTION

This collet is not compatible with Profit Maker Tools.
The tolerance of the cutting tool shank must be within h7.

COLLET SET

For NEW BABY

The NEW BABY COLLET SET contains all the required collets to cover entire clamping range.



Provided with a Polypropylene Case

Catalog Number	Capacity	Number of Collet	Case Size (LxWxH)	Corresponding Chuck Model
SNBC6AA-22	.010-.236	22	7.87 x 6.69 x 1.97 (200 x 170 x 50)	MEGA6N / NBS6
SNBC8AA-20	.020-.315	20		MEGA8N / NBS8
SNBC10AA-20	.059-.394	20		MEGA10N / NBS10
SNBC13AA-21	.098-.512	21	9.65 x 8.27 x 2.36 (245 x 210 x 60)	MEGA13N / NBS13
SNBC16AA-27	.098-.630	27	10.83 x 9.05 x 2.56 (275 x 230 x 65)	MEGA16N / NBS16
SNBC20AA-35	.098-.787	35	12.20 x 10.24 x 2.95 (310 x 260 x 75)	MEGA20N / NBS20
SNBC25AA-19	.610-.984	19		MEGA25N

- SNBC6AA NEW BABY COLLET SET does not include NBC6-0.5 and 3.175 collets
- SNBC8AA, 10AA, 13AA NEW BABY COLLET SET does not include NBC-3.175 Collet
- Provided in an exclusive storage box

COLLET CASE

For NEW BABY

Exclusive case to protect and maintain the high precision collets.



Provided with a Polypropylene Case

Catalog Number	Number of Holes	Case Size (LxWxH)	Corresponding Chuck Model
NBB6	60	7.87 x 6.69 x 1.97 (200 x 170 x 50)	NBC6 / FONBC6
NBB8	50		NBC8 / FONBC8
NBB10	40		NBC10 / FONBC10
NBB13	35	9.65 x 8.27 x 2.36 (245 x 210 x 60)	NBC13 / FONBC13
NBB16	35	10.83 x 9.05 x 2.56 (275 x 230 x 65)	NBC16 / FONBC16
NBB20	45	12.20 x 10.24 x 2.95 (310 x 260 x 75)	NBC20 / FONBC20
NBB25	28		NBC25/FONBC25

- The NEW BABY COLLET CASE cannot be used for End Mill type

FONBC COOLANT COLLET

CLAMPING DIAMETER: ϕ .114"-1.000"

For MEGA NEW BABY CHUCK & NEW BABY CHUCK

An ideal collet for through-tool use with tools with oil holes such as oil hole drills.

MAX COOLANT
PRESSURE
1000
PSI

FOR TOOLS WITH
OIL HOLES

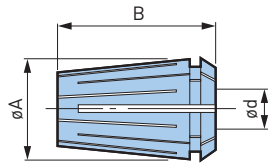
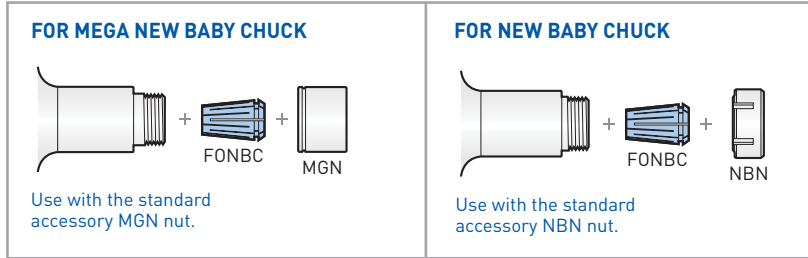
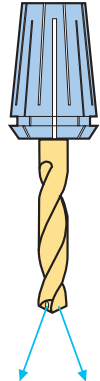

MEGA 6N/NBS6

Catalog Number	Clamping Size ϕd
FONBC6-3AA	.118 \diamond
-3.25AA	.124-.130
-3.5AA	.134-.138
-3.75AA	.144-.148
-4AA	.154-.157
-4.25AA	.163-.167
-4.5AA	.173-.177
-4.75AA	.183-.187
-5AA	.193-.197
-5.25AA	.203-.207
-5.5AA	.213-.217
-5.75AA	.222-.226
-6AA	.232-.236

$\phi A = .36$ (9.5mm) $B = .55$ (14mm)
 \diamond No collapsibility

MEGA 8N/NBS8

Catalog Number	Clamping Size ϕd
FONBC8-3AA	.114-.118
-3.5AA	.134-.138
-4-AA	.154-.157
-4.5AA	.173-.177
-5AA	.193-.197
-5.5AA	.213-.217
-6AA	.232-.236
-6.5AA	.250-.256
-7AA	.271-.276
-7.5AA	.291-.295
-8AA	.311-.315

$\phi A = .49$ (12.5mm) $B = .71$ (18mm)

MEGA 10N/NBS10

Catalog Number	Clamping Size ϕd
FONBC10-3AA	.114-.118
-3.5AA	.134-.138
-4AA	.154-.157
-4.5AA	.173-.177
-5AA	.193-.197
-5.5AA	.213-.217
-6AA	.232-.236
-6.5AA	.250-.256
-7AA	.271-.276
-7.5AA	.291-.295
-8AA	.311-.315
-8.5AA	.331-.335
-9AA	.350-.354
-9.5AA	.370-.375
-10AA	.390-.394

$\phi A = .65$ (16.5mm) $B = 1.06$ (27mm)

MEGA 13N/NBS13

Catalog Number	Clamping Size ϕd
FONBC13-3AA	.118 \diamond
-3.5AA	.134-.138
-4AA	.138-.157
-4.5AA	.173-.177
-5AA	.193-.197
-5.5AA	.213-.217
-6AA	.232-.236
-6.5AA	.250-.256
-7AA	.271-.276
-7.5AA	.291-.295
-8AA	.311-.315
-8.5AA	.331-.335
-9AA	.350-.354
-9.5AA	.370-.375
-10AA	.390-.394
-10.5AA	.409-.413
-11AA	.429-.433
-11.5AA	.449-.453
-12AA	.468-.472
-12.5AA	.488-.492
-13AA	.508-.512

$\phi A = .81$ (20.5mm) $B = 1.22$ (31mm)
 \diamond No collapsibility

MEGA 16N/NBS16

Catalog Number	Clamping Size ød
FONBC16-5AA	.193-.197
-5.5AA	.213-.217
-6AA	.232-.236
-6.5AA	.250-.256
-7AA	.272-.276
-7.5AA	.291-.295
-8AA	.311-.315
-8.5AA	.331-.335
-9AA	.350-.354
-9.5AA	.371-.375
-10AA	.390-.394
-10.5AA	.409-.413
-11AA	.429-.433
-11.5AA	.449-.453
-12AA	.468-.472
-12.5AA	.488-.492
-13AA	.508-.512
-13.5AA	.527-.531
-14AA	.547-.551
-14.5AA	.567-.571
-15AA	.587-.591
-15.5AA	.606-.610
-16AA	.625-.630

øA=1.00 [25.5mm] B=1.38 [35mm]

MEGA 20N/NBS20

Catalog Number	Clamping Size ød
FONBC20-5AA	.193-.197
-5.5AA	.213-.217
-6AA	.232-.236
-6.5AA	.250-.256
-7AA	.272-.276
-7.5AA	.291-.295
-8AA	.311-.315
-8.5AA	.331-.335
-9AA	.351-.354
-9.5AA	.371-.375
-10AA	.390-.394
-10.5AA	.409-.413
-11AA	.429-.433
-11.5AA	.449-.453
-12AA	.468-.472
-12.5AA	.488-.492
-13AA	.508-.512
-13.5AA	.527-.531
-14AA	.547-.551
-14.5AA	.567-.571
-15AA	.587-.591
-15.5AA	.606-.610
-16AA	.625-.630
-16.5AA	.646-.650
-17AA	.665-.669
-17.5AA	.685-.689
-18AA	.705-.709
-18.5AA	.724-.728
-19AA	.746-.750
-19.5AA	.764-.768
-20AA	.783-.787

øA=1.12 [28.5] B=1.50 [38mm]

MEGA 25N/NBS25

Catalog Number	Clamping Size ød
FONBC25-16AA	.625-.630
-17AA	.665-.669
-18AA	.705-.709
-19AA	.746-.750
-20AA	.783-.787
-21AA	.823-.827
-22AA	.862-.866
-23AA	.902-.906
-24AA	.941-.945
-25AA	.980-.984
-25.4AA	.996-1.000

øA=1.40 [35.5mm] B=2.05 [52mm]

CAUTION 

Note that collapsibility differs from the NBC collets.

MEGA NEW BABY NUT

A high precision nut with excellent sealing properties, preventing the intrusion of coolant.

STANDARD TYPE

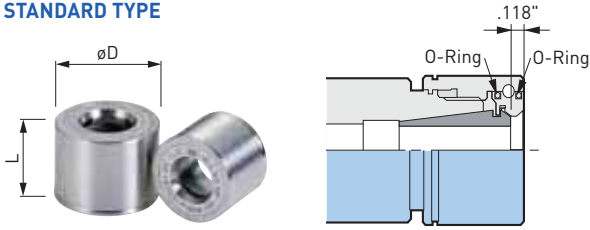

Catalog Number	øD	L	Body Type
MGN6	.79 [20mm]	.81 [20.5mm]	MEGA6N
MGN8	.98 [25mm]	.91 [23mm]	MEGA8N
MGN10	1.18 [30mm]	.94 [24mm]	MEGA10N
MGN13	1.38 [35mm]	1.06 [27mm]	MEGA13N
MGN16	1.65 [42mm]		MEGA16N
MGN20	1.81 [46mm]		MEGA20N
MGN25	2.36 [60mm]		MEGA25N

FLUSH TYPE

For flood coolant only

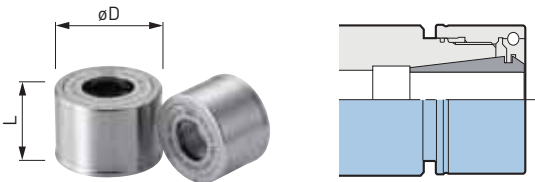

Catalog Number	øD	L	Body Type
MGN6F	.79 [20mm]	.71 [18mm]	MEGA6N
MGN8F	.98 [25mm]	.79 [20mm]	MEGA8N
MGN10F	1.18 [30mm]	.83 [21mm]	MEGA10N
MGN13F	1.38 [35mm]	.94 [24mm]	MEGA13N
MGN16F	1.65 [42mm]	.96 [24.5mm]	MEGA16N
MGN20F	1.81 [46mm]		MEGA20N



MEGA PERFECT SEAL

CLAMPING RANGE: ϕ .118"- ϕ .787"

Unique design increases sealing performance with higher coolant pressure to create a perfect seal. Standard NBC Collet can be used.

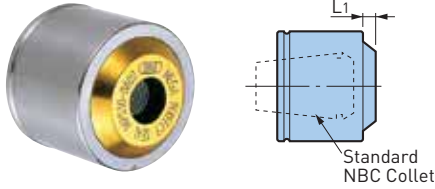

Two Way Coolant



MAX COOLANT PRESSURE
1,000
PSI

MEGA 6N

Catalog Number	L1	Cutter Shank ϕ	Collet Model
MPS6-03035	.091	.118-.138	NBC6-3-3.75
-0304		.118-.157	-3-4.25
-04045		.157-.177	-4-4.75
-0405		.157-.197	-4-5.25
-05055		.197-.217	-5-5.75
-0506		.197-.236	-5-6

• PS Ring is included

MEGA 8N

Catalog Number	L1	Cutter Shank ϕ	Collet Model
MPS8-03035	.154	.118-.138	NBC8-3-4
-0304		.118-.157	-3-4.5
-04045		.157-.177	-4-5
-0405		.157-.197	-4-5.5
-05055		.197-.217	-5-6
-0506	.134	.197-.236	-5-6.5
-06065		.236-.256	-6-7
-0607		.236-.276	-6-7.5
-07075		.276-.295	-7-8
-0708		.276-.315	-7-8

• PS Ring is included

MEGA 10N

Catalog Number	L1	Cutter Shank ϕ	Collet Model
MPS10-03035	.154	.118-.138	NBC10-3-4
-0304		.118-.157	-3-4.5
-04045		.157-.177	-4-5
-0405		.157-.197	-4-5.5
-05055		.197-.217	-5-6
-0506		.197-.236	-5-6.5
-06065	.169	.236-.256	-6-7
-0607		.236-.276	-6-7.5
-07075		.276-.295	-7-8
-0708		.276-.315	-7-8.5
-08085	.138	.315-.335	-8-9
-0809		.315-.354	-8-9.5
-09095		.354-.375	-9-10
-0910		.354-.394	-9-10

• PS Ring is included

MEGA 13N

Catalog Number	L1	Cutter Shank ϕ	Collet Model
MPS13-03035	.169	.118-.138	NBC13-3-4
-0304		.118-.157	-3-4.5
-04045		.157-.177	-4-5
-0405		.157-.197	-4-5.5
-05055		.197-.217	-5-6
-0506		.197-.236	-5-6.5
-06065	.181	.236-.256	-6-7
-0607		.236-.276	-6-7.5
-07075		.276-.295	-7-8
-0708		.276-.315	-7-8.5
-08085	.193	.315-.335	-8-9
-0809		.315-.354	-8-9.5
-09095		.354-.375	-9-10
-0910		.354-.394	-9-10.5
-10105	.165	.394-.413	-10-11
-1011		.394-.433	-10-11.5
-11115		.433-.453	-11-12
-1112		.433-.472	-11-12.5
-12125		.472-.492	-12-13
-1213		.472-.512	-12-13

• PS Ring is included

MEGA 16N

Catalog Number	L1	Cutter Shank ø	Collet Model
MPS16-03035	.157	.118-.138	NBC16-3-4
-0304		.118-.157	-3-4.5
-04045		.157-.177	-4-5
-0405		.157-.197	-4-5.5
-05055		.197-.217	-5-6
-0506		.197-.236	-5-6.5
-06065	.169	.236-.256	-6-7
-0607		.236-.276	-6-7.5
-07075		.276-.295	-7-8.5
-0708		.276-.315	-7-8.5
-08085	.181	.315-.335	-8-9
-0809		.315-.354	-8-9.5
-09095		.354-.375	-9-10
-0910		.354-.394	-9-10.5
-10105	.201	.394-.413	-10-11
-1011		.394-.433	-10-11.5
-11115		.433-.453	-11-12
-1112		.433-.472	-11-12.5
-12125	.161	.472-.492	-12-13
-1213		.472-.512	-12-13.5
-1314		.512-.551	-13-14.5
-1415		.551-.591	-14-15.5
-1516		.591-.630	-15-16

• PS Ring is included

MEGA 20N

Catalog Number	L1	Cutter Shank ø	Collet Model
MPS20-03035	.157	.118-.138	NBC20-3-4
-0304		.118-.157	-3-4.5
-04045		.157-.177	-4-5
-0405		.157-.197	-4-5.5
-05055		.197-.217	-5-6
-0506		.197-.236	-5-6.5
-06065	.169	.236-.256	-6-7
-0607		.236-.276	-6-7.5
-07075		.276-.295	-7-8
-0708		.276-.315	-7-8.5
-08085	.181	.315-.335	-8-9
-0809		.315-.354	-8-9.5
-09095		.354-.375	-9-10
-0910		.354-.394	-9-10.5
-10105	.201	.394-.413	-10-11
-1011		.394-.433	-10-11.5
-11115		.433-.453	-11-12
-1112		.433-.472	-11-12.5
-12125	.205	.472-.492	-12-13
-1213		.472-.512	-12-13.5
-1314		.512-.551	-13-14.5
-1415		.551-.591	-14-15.5
-1516	.181	.591-.630	-15-16.5
-1617		.630-.669	-16-17.5
-1718		.669-.709	-17-18.5
-1819		.709-.750	-18-19.5
-1920		.751-.787	-19-20

• PS Ring is included

CAUTION 

For Jet Through application by removing the PS Ring, it is recommended to use the largest clamping range of the nut corresponding to the tool shank diameter.

BABY PERFECT SEAL

CLAMPING RANGE: ϕ .118"-.787"

Unique design increases sealing performance with higher coolant pressure to create a perfect seal and reliable coolant supply to the tool tip.

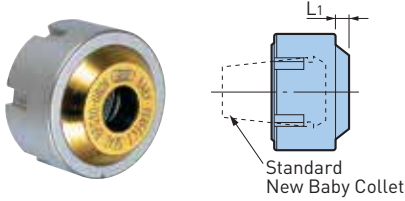

Two Way Coolant



MAX COOLANT PRESSURE
1,000
PSI

NBC6

Catalog Number	L1	Cutter Shank ϕ	Collet Model
BPS6-03035	.091	.118-.138	NBC6-3-3.75
-0304		.118-.157	-3-4.25
-04045		.157-.177	-4-4.75
-0405		.157-.197	-4-5.25
-05055		.197-.217	-5-5.75
-0506		.197-.236	-5-6

• PS Ring is included

NBC8

Catalog Number	L1	Cutter Shank ϕ	Collet Model
BPS8-03035	.154	.118-.138	NBC8-3-4
-0304		.118-.157	-3-4.5
-04045		.157-.177	-4-5
-0405		.157-.197	-4-5.5
-05055		.197-.217	-5-6
-0506		.197-.236	-5-6.5
-06065	.134	.236-.256	-6-7
-0607		.236-.276	-6-7.5
-07075		.276-.295	-7-8
-0708		.276-.315	-7-8

• PS Ring is included

NBC10

Catalog Number	L1	Cutter Shank ϕ	Collet Model
BPS10-03035	.154	.118-.138	NBC10-3-4
-0304		.118-.157	-3-4.5
-04045		.157-.177	-4-5
-0405		.157-.197	-4-5.5
-05055		.197-.217	-5-6
-0506		.197-.236	-5-6.5
-06065	.169	.236-.256	-6-7
-0607		.236-.276	-6-7.5
-07075		.276-.295	-7-8
-0708		.276-.315	-7-8.5
-08085	.138	.315-.335	-8-9
-0809		.315-.354	-8-9.5
-09095		.354-.375	-9-10
-0910	.354-.394	-9-10	

• PS Ring is included

NBC13

Catalog Number	L1	Cutter Shank ϕ	Collet Model
BPS13-03035	.169	.118-.138	NBC13-3-4
-0304		.118-.157	-3-4.5
-04045		.157-.177	-4-5
-0405		.157-.197	-4-5.5
-05055		.197-.217	-5-6
-0506		.197-.236	-5-6.5
-06065	.181	.236-.256	-6-7
-0607		.236-.276	-6-7.5
-07075		.276-.295	-7-8
-0708		.276-.315	-7-8.5
-08085	.193	.315-.335	-8-9
-0809		.315-.354	-8-9.5
-09095		.354-.375	-9-10
-0910	.354-.394	-9-10.5	
-10105	.165	.394-.413	-10-11
-1011		.394-.433	-10-11.5
-11115		.433-.453	-11-12
-1112		.433-.472	-11-12.5
-12125		.472-.492	-12-13
-1213		.472-.512	-12-13

• PS Ring is included

NBC16

Catalog Number	L1	Cutter Shank ø	Collet Model
BPS16-03035	.157	.118-.138	NBC16-3-4
-0304		.118-.157	-3-4.5
-04045		.157-.177	-4-5
-0405		.157-.197	-4-5.5
-05055		.197-.217	-5-6
-0506		.197-.236	-5-6.5
-06065	.169	.236-.256	-6-7
-0607		.236-.276	-6-7.5
-07075		.276-.295	-7-8
-0708		.276-.315	-7-8.5
-08085	.181	.315-.335	-8-9
-0809		.315-.354	-8-9.5
-09095		.354-.375	-9-10
-0910		.354-.394	-9-10.5
-10105	.201	.394-.413	-10-11
-1011		.394-.433	-10-11.5
-11115		.433-.453	-11-12
-1112		.433-.472	-11-12.5
-12125	.161	.472-.492	-12-13
-1213		.472-.512	-12-13.5
-1314		.512-.551	-13-14.5
-1415		.551-.591	-14-15.5
-1516		.591-.630	-15-16

• PS Ring is included

NBC20

Catalog Number	L1	Cutter Shank ø	Collet Model
BPS20-03035	.157	.118-.138	NBC20-3-4
-0304		.118-.157	-3-4.5
-04045		.157-.177	-4-5
-0405		.157-.197	-4-5.5
-05055		.197-.217	-5-6
-0506		.197-.236	-5-6.5
-06065	.169	.236-.256	-6-7
-0607		.236-.276	-6-7.5
-07075		.276-.295	-7-8
-0708		.276-.315	-7-8.5
-08085	.181	.315-.335	-8-9
-0809		.315-.354	-8-9.5
-09095		.354-.375	-9-10
-0910		.354-.394	-9-10.5
-10105	.201	.394-.413	-10-11
-1011		.394-.433	-10-11.5
-11115		.433-.453	-11-12
-1112		.433-.472	-11-12.5
-12125	.205	.472-.492	-12-13
-1213		.472-.512	-12-13.5
-1314		.512-.551	-13-14.5
-1415		.551-.591	-14-15.5
-1516		.591-.630	-15-16.5
-1617	.181	.630-.669	-16-17.5
-1718		.669-.709	-17-18.5
-1819		.709-.750	-18-19.5
-1920		.751-.787	-19-20

• PS Ring is included

CAUTION 

For Jet Through application by removing the PS Ring, it is recommended to use the largest clamping range of the nut corresponding to the tool shank diameter.

NEW BABY NUT

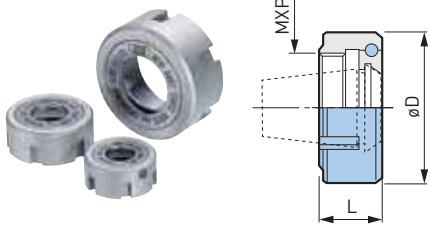

Catalog Number	øD	L	MxP	Body Type
NBN6	.79 (20mm)	.37 (9.5mm)	M12x1	NBS6
NBN8	.98 (25mm)	.43 (11mm)	M16x1	NBS8
NBN10	1.18 (30mm)	.49 (12.5mm)	M21x1	NBS10
NBN13	1.38 (35mm)	.63 (16mm)	M26x1	NBS13
NBN16	1.65 (42mm)		M32x1	NBS16
NBN20	1.81 (46mm)		M36x1	NBS20

SPANNER WRENCH

For NEW BABY CHUCKS & MEGA ER GRIP

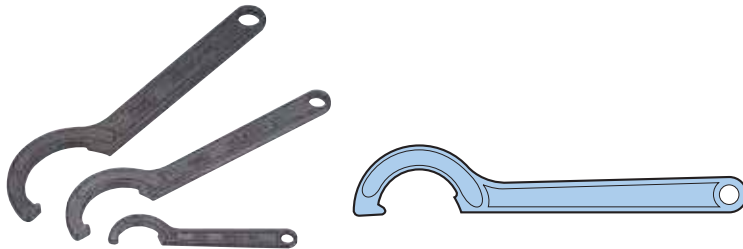

Catalog Number	Nut Diameter	NBS Nut	BPS Sealed Nut
NBK6	.79 (20mm)	NBS6	BPS6
NBK8	.98 (25mm)	NBS8	BPS8
NBK10	1.18 (30mm)	NBS10	BPS10
NBK13	1.38 (35mm)	NBS13	BPS13
NBK16	1.65 (42mm)	NBS16	BPS16
NBK20	1.81 (46mm)	NBS20	BPS20

TORQUE WRENCH

For NEW BABY CHUCKS
Wrench with torque limiter.



Catalog Number		Nut Model
NBK6TL	NBK6TLS❖	NBN6/BPS6
NBK8TL	NBK8TLS❖	NBN8/BPS8
NBK10TL	—	NBN10/BPS10
NBK13TL	—	NBN13/BPS13
NBK16TL	—	NBN16/BPS16
NBK20TL	—	NBN20/BPS20

❖ For ø3mm or smaller shank tools use TLS models

COLLET EJECTOR

Easily and quickly insert/remove small sizes of NEW BABY COLLETS from MEGA NUTS & NEW BABY NUTS.



For NEW BABY COLLET

Catalog Number	Nut	Collet
NBC6-CE	MGN6, NBN6	NBC6
NBC8-CE	MGN8, NBN8	NBC8
NBC10-CE	MGN10, NBN10	NBC10
NBC13-CE	MGN13, NBN13	NBC13

For NEW BABY END MILL COLLET

Catalog Number	Nut	Collet
NBC6E-CE	MGN6, NBN6	NBC6E
NBC8E-CE	MGN8, NBN8	NBC8E
NBC10E-CE	MGN10, NBN10	NBC10E
NBC13E-CE	MGN13, NBN13	NBC13E

How to Insert a Collet

1. Insert the collet into the Collet Ejector. Then insert it into the nut.

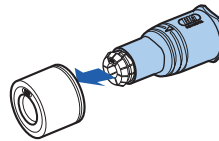

2. Depress the piston and remove the Collet Ejector.

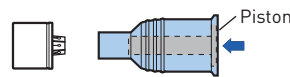

How to Remove a Collet

1. Tilt the Collet Ejector as shown in the picture to remove the collet from the nut.

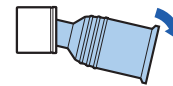

2. Depress the piston and the collet will be removed.

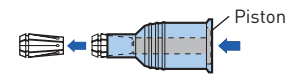

COLLET REMOVER

Eases removal of the collet from the nut. Especially helpful for small collet series (MEGA6N to 13N).

How to Use

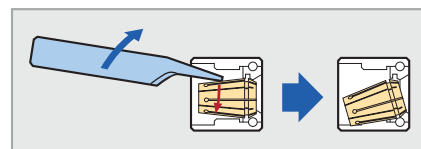

Catalog Number
NBJ

α TAPER CLEANER

For MEGA NEW BABY CHUCKS & NEW BABY CHUCKS

To maintain the accuracy of high precision collet chucks by cleaning the internal collet taper.

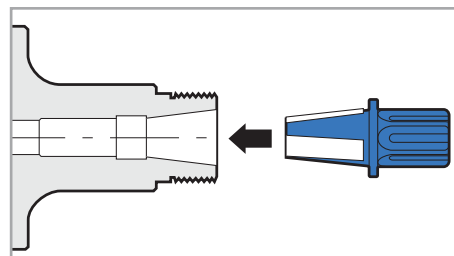

Catalog Number	Chuck Body
SC-NBC6	MEGA6N, NBS6
SC-NBC8	MEGA8N, NBS8
SC-NBC10	MEGA10N, NBS10
SC-NBC13	MEGA13N, NBS13
SC-NBC16	MEGA16N, NBS16
SC-NBC20	MEGA20N, NBS20

ERC COLLET

Each ERC collet is inspected twice (0° and 180°) at 4 times diameter to guarantee the runout accuracy. The "AA grade" is marked on only those collets that pass the inspection process for accuracy.

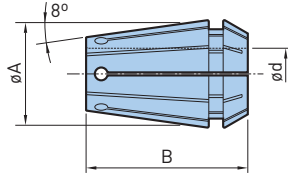

Guaranteed Max Runout

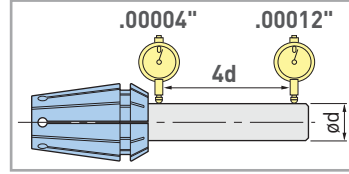

All BIG Collets are AA Grade and inspected twice for accuracy

MEGA ER11

Catalog Number	Clamping Range ød
ERC11-3AA	.108-.118
-3.25AA	.118-.128
-3.5AA	.128-.138
-3.75AA	.138-.148
-4AA	.148-.157
-4.25AA	.157-.167
-4.5AA	.167-.177
-4.75AA	.177-.187
-5AA	.187-.197
-5.25AA	.197-.207
-5.5AA	.207-.217
-5.75AA	.217-.226
-6AA	.217-.236

øA=.43 (11mm) B=.71 (18mm)

MEGA ER16

Catalog Number	Clamping Range ød
ERC16-2AA	.075-.079
-2.1AA	.079-.083
-2.2AA	.083-.087
-2.3AA	.087-.091
-2.4AA	.091-.094
-2.5AA	.094-.098
-2.6AA	.098-.102
-2.7AA	.102-.106
-2.8AA	.106-.110
-2.9AA	.110-.114
-3AA	.108-.118
-3.25AA	.118-.128
-3.5AA	.128-.138
-3.75AA	.138-.148
-4AA	.148-.157
-4.25AA	.157-.167
-4.5AA	.167-.177
-4.75AA	.177-.187
-5AA	.187-.197
-5.25AA	.197-.207
-5.5AA	.207-.217
-5.75AA	.217-.226
-6AA	.217-.236
-6.5AA	.236-.256
-7AA	.256-.276
-7.5AA	.276-.295
-8AA	.295-.315
-8.5AA	.315-.335
-9AA	.335-.354
-9.5AA	.354-.375
-10AA	.376-.394

øA=.63 (16mm) B=1.08 (27.5mm)

MEGA ER20

Catalog Number	Clamping Range ød
ERC20-3AA	.108-.118
-3.25AA	.118-.128
-3.5AA	.128-.138
-3.75AA	.138-.148
-4AA	.148-.157
-4.25AA	.157-.167
-4.5AA	.167-.177
-4.75AA	.177-.187
-5AA	.187-.197
-5.25AA	.197-.207
-5.5AA	.207-.217
-5.75AA	.217-.226
-6AA	.217-.236
-6.5AA	.236-.256
-7AA	.256-.276
-7.5AA	.276-.295
-8AA	.295-.315
-8.5AA	.315-.335
-9AA	.335-.354
-9.5AA	.354-.375
-10AA	.376-.394
-10.5AA	.394-.413
-11AA	.413-.433
-11.5AA	.433-.453
-12AA	.453-.472
-12.5AA	.472-.492
-13AA	.492-.512

øA=.79 (20mm) B=1.24 (31.5mm)

MEGA ER25

Catalog Number	Clamping Range ϕd
ERC25-3AA	.108-.118
-3.25AA	.118-.128
-3.5AA	.128-.138
-3.75AA	.138-.148
-4AA	.148-.157
-4.25AA	.157-.167
-4.5AA	.167-.177
-4.75AA	.177-.187
-5AA	.187-.197
-5.25AA	.197-.207
-5.5AA	.207-.217
-5.75AA	.217-.226
-6AA	.217-.236
-6.5AA	.236-.256
-7AA	.256-.276
-7.5AA	.276-.295
-8AA	.295-.315
-8.5AA	.315-.335
-9AA	.335-.354
-9.5AA	.354-.375
-10AA	.376-.394
-10.5AA	.394-.413
-11AA	.413-.433
-11.5AA	.433-.453
-12AA	.453-.472
-12.5AA	.472-.492
-13AA	.492-.512
-13.5AA	.512-.531
-14AA	.531-.551
-14.5AA	.551-.571
-15AA	.571-.591
-15.5AA	.591-.610
-16AA	.610-.630

$\phi A = .98$ [25mm] $B = 1.34$ [24mm]

MEGA ER32

Catalog Number	Clamping Range ϕd
ERC32-3AA	.108-.118
-3.25AA	.118-.128
-3.5AA	.128-.138
-3.75AA	.138-.148
-4AA	.148-.157
-4.25AA	.157-.167
-4.5AA	.167-.177
-4.75AA	.177-.187
-5AA	.187-.197
-5.25AA	.197-.207
-5.5AA	.207-.217
-5.75AA	.217-.226
-6AA	.217-.236
-6.5AA	.236-.256
-7AA	.256-.276
-7.5AA	.276-.295
-8AA	.295-.315
-8.5AA	.315-.335
-9AA	.335-.354
-9.5AA	.354-.375
-10AA	.376-.394
-10.5AA	.394-.413

Catalog Number	Clamping Range ϕd
ERC32-11AA	.413-.433
-11.5AA	.433-.453
-12AA	.453-.472
-12.5AA	.472-.492
-13AA	.492-.512
-13.5AA	.512-.531
-14AA	.531-.551
-14.5AA	.551-.571
-15AA	.571-.591
-15.5AA	.591-.610
-16AA	.610-.630
-16.5AA	.630-.650
-17AA	.650-.670
-17.5AA	.670-.690
-18AA	.690-.709
-18.5AA	.709-.728
-19AA	.728-.749
-19.5AA	.750-.768
-20AA	.768-.787

$\phi A = 1.26$ [32mm] $B = 1.58$ [40mm]

- BIG's ERC collets have a maximum clamping capacity of $.020/\phi$ (.5mm/ ϕ)
- To obtain the best runout accuracy and rigidity, ERC collets for smaller tools have a reduced clamping range
- For best results, users should avoid clamping tools with shank diameters less than the recommended clamping range

CAUTION 

Conventional DIN collets have a clamping range of $1\text{mm}/\phi$. Never use ERC collets for more than $.020/\phi$ (.5mm/ ϕ) below nominal size. To maintain the accuracy of the tool assembly, do not use collets and nuts manufactured by another company with the chuck body of BIG's MEGA ER GRIP. We cannot guarantee the accuracy statement for our collets if they are assembled on the chuck body of another manufacturer.

ERC END MILL COLLET

"Just fit" collet for end mills. Nominal sizes of collets for the most popular end mill shank reduces the unsupported overhang of the collet when clamped into the chuck body. This increases the rigidity of the tool assembly in the horizontal direction which is very important to end milling operations. Available in both metric and inch sizes.

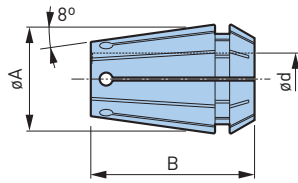

Guaranteed Max Runout

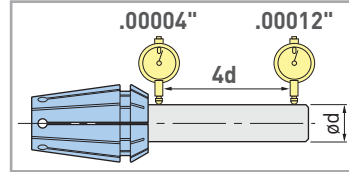

All BIG Collets are AA Grade and inspected twice for accuracy

MEGA ER16

Catalog Number	Clamping Range ϕd
ERC16-1/8EAA	.125
-3/16EAA	.188
-1/4EAA	.250
-5/16EAA	.312
-3/8EAA	.375
-3EAA	3.0mm
-4EAA	4.0mm
-5EAA	5.0mm
-6EAA	6.0mm
-7EAA	7.0mm
-8EAA	8.0mm
-9EAA	9.0mm
-10EAA	10.0mm

$\phi A = .63$ (16mm) $B = 1.08$ (27.5mm)

MEGA ER20

Catalog Number	Clamping Range ϕd
ERC20-1/8EAA	.125
-3/16EAA	.188
-1/4EAA	.250
-5/16EAA	.312
-3/8EAA	.375
-7/16EAA	.438
-1/2EAA	.500
-3EAA	3.0mm
-4EAA	4.0mm
-5EAA	5.0mm
-6EAA	6.0mm
-7EAA	7.0mm
-8EAA	8.0mm
-9EAA	9.0mm
-10EAA	10.0mm
-11EAA	11.0mm
-12EAA	12.0mm

$\phi A = .79$ (20mm) $B = 1.24$ (31.5mm)

MEGA ER25

Catalog Number	Clamping Range ϕd
ERC25-1/8EAA	.125
-3/16EAA	.188
-1/4EAA	.250
-5/16EAA	.312
-3/8EAA	.375
-7/16EAA	.438
-1/2EAA	.500
-9/16EAA	.563
-5/8EAA	.625
-3EAA	3.0mm
-4EAA	4.0mm
-5EAA	5.0mm
-6EAA	6.0mm
-7EAA	7.0mm
-8EAA	8.0mm
-9EAA	9.0mm
-10EAA	10.0mm
-11EAA	11.0mm
-12EAA	12.0mm
-13EAA	13.0mm
-14EAA	14.0mm
-15EAA	15.0mm
-16EAA	16.0mm

$\phi A = .98$ (25mm) $B = 1.34$ (34mm)

MEGA ER32

Catalog Number	Clamping Range ϕd
ERC32-1/8EAA	.125
-3/16EAA	.188
-1/4EAA	.250
-5/16EAA	.312
-3/8EAA	.375
-7/16EAA	.438
-1/2EAA	.500
-9/16EAA	.563
-5/8EAA	.625
-3/4EAA	.750
-3EAA	3.0mm
-4EAA	4.0mm
-5EAA	5.0mm
-6EAA	6.0mm
-7EAA	7.0mm
-8EAA	8.0mm
-9EAA	9.0mm
-10EAA	10.0mm
-11EAA	11.0mm
-12EAA	12.0mm
-13EAA	13.0mm
-14EAA	14.0mm
-15EAA	15.0mm
-16EAA	16.0mm
-18EAA	18.0mm
-20EAA	20.0mm

$\phi A = 1.26$ (32mm) $B = 1.58$ (40mm)

A Variety of Nuts are Available For MEGA ER CHUCKS



MEGA ER PERFECT SEAL



MEGA WRENCH

Capable of sealing high pressure coolant up to 1000 PSI. For applications with coolant supplied through the tools. Mega Wrench is used for tightening.



MEGA ER NUT



MEGA WRENCH

High accuracy and clamping force are provided with thrust ball bearings. Ideal for solid carbide drills and reamers. Slot-free outer diameter increases rigidity of the nut itself. The one-way clutch of the Mega Wrench tightens the nut securely and easily by ratchet function.



MEGA ER SOLID NUT



MEGA WRENCH

High performance solid nut with surface treatment for friction reduction. Slot-free outer diameter increases rigidity of the nut itself. The one-way clutch of the Mega Wrench tightens the nut securely and easily by ratchet function.



ER NUT

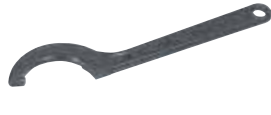

SPANNER WRENCH

Basic nut with surface treatment for friction reduction. Spanner wrench is used for tightening.

MEGA ER NUT

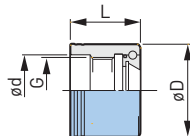

Catalog Number	øD	L	G	ød	Wrench Type	Body Type
MERN16	1.181	.984	M22×P1.5	.906	MGR30L	MEGAER16
MERN20	1.378	1.043	M25×P1.5	1.063	MGR35L	MEGAER20
MERN25	1.654	1.083	M32×P1.5	1.319	MGR42L	MEGAER25
MERN32	1.969	1.189	M40×P1.5	1.614	MGR50L	MEGAER32

ER NUT

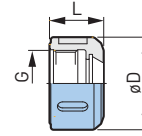

Catalog Number	øD	L	G	Spanner Type	Body Type
ERN11	.748	.484	M14×P0.75	NBK6	ER11
ERN16	1.181	.748	M22×P1.5	NBK10	ER16
ERN20	1.378	.807	M25×P1.5	NBK13	ER20
ERN25	1.654	.846	M32×P1.5	NBK16	ER25
ERN32	1.969	.945	M40×P1.5	FK45-50L	ER32

MEGA ER SOLID NUT

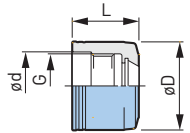

Catalog Number	øD	L	G	ød	Wrench Type	Body Type
MER16SN	1.181	.984	M22×P1.5	.906	MGR30L	MEGAER16
MER20SN	1.378	1.043	M25×P1.5	1.063	MGR35L	MEGAER20
MER25SN	1.654	1.083	M32×P1.5	1.319	MGR42L	MEGAER25
MER32SN	1.969	1.189	M40×P1.5	1.614	MGR50L	MEGAER32

MEGA ER PERFECT SEAL

Sealed collet nut for coolant-through tools.

WITH PS RING

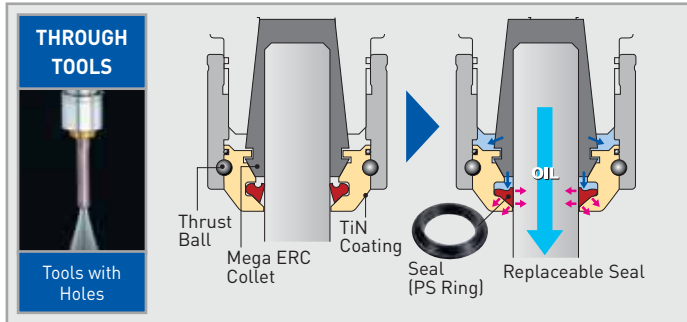

WITHOUT PS RING

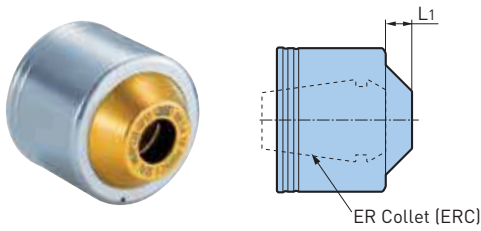
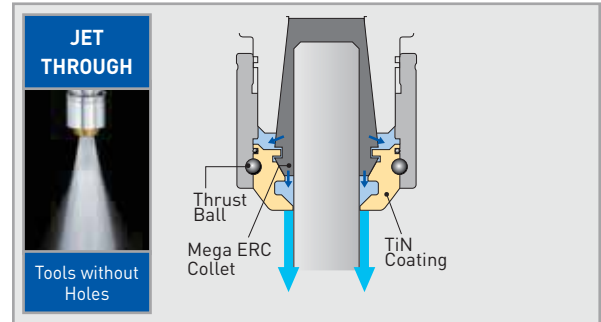

MAX COOLANT PRESSURE
1,000
PSI

Catalog Number	L1	Cutter Shank ø	Collet Model (Inch)	Collet Model (Metric)
MERPS16-030035	.252	.118-.138	ERC16-1/8E	ERC16-3-3.75
-035040		.138-.157	—	-3.5-4.25
-040045		.157-.177	—	-4-4.75
-045050		.177-.197	-3/16E	-4.5-5.25
-050055		.197-.217	—	-5-6
-055060		.217-.236	—	-5.5-6.5
-060065	.268	.236-.256	-1/4E	-6-7
-065070		.256-.276	—	-6.5-7.5
-070075		.276-.295	—	-7-8
-075080		.295-.315	-5/16E	-7.5-8.5
-080085	.240	.315-.335	—	-8-9
-085090		.335-.354	—	-8.5-9.5
-090095		.354-.375	-3/8E	-9-10
-095100		.374-.394	—	-9.5-10

Catalog Number	L1	Cutter Shank ø	Collet Model (Inch)	Collet Model (Metric)
MERPS20-030035	.252	.118-.138	ERC20-1/8E	ERC20-3-3.75
-035040		.138-.157	—	-3.5-4.25
-040045		.157-.177	—	-4-4.75
-045050		.177-.197	-3/16E	-4.5-5.25
-050055		.197-.217	—	-5-6
-055060		.217-.236	—	-5.5-6.5
-060065	.268	.236-.256	-1/4E	-6-7
-065070		.256-.276	—	-6.5-7.5
-070075		.276-.295	—	-7-8
-075080		.295-.315	-5/16E	-7.5-8.5
-080085	.272	.315-.335	—	-8-9
-085090		.335-.354	—	-8.5-9.5
-090095		.354-.375	-3/8E	-9-10
-095100		.374-.394	—	-9.5-10.5
-100105	.260	.394-.413	—	-10-11
-105110		.413-.433	—	-10.5-11.5
-110115		.433-.453	-7/16E	-11-12
-115120		.453-.472	—	-11.5-12.5
-120125		.472-.492	—	-12-13
-125130		.492-.512	-1/2E	-12.5-13

Catalog Number	L1	Cutter Shank ø	Collet Model (Inch)	Collet Model (Metric)
MERPS25-030035	.248	.118-.138	ERC25-1/8E	ERC25-3-3.75
-035040		.138-.157	—	-3.5-4.25
-040045		.157-.177	—	ERC25-4-4.75
-045050		.177-.197	ERC25-3/16E	-4.5-5.25
-050055		.197-.217	—	-5-6
-055060		.217-.236	—	-5.5-6.5
-060065	.264	.236-.256	-1/4E	-6-7
-065070		.256-.276	—	-6.5-7.5
-070075		.276-.295	—	-7-8
-075080		.295-.315	-5/16E	-7.5-8.5
-080085	.268	.315-.335	—	-8-9
-085090		.335-.354	—	-8.5-9.5
-090095		.354-.375	-3/8E	-9-10
-095100		.374-.394	—	-9.5-10.5
-100105	.287	.394-.413	—	-10-11
-105110		.413-.433	—	-10.5-11.5
-110115		.433-.453	-7/16E	-11-12
-115120		.453-.472	—	-11.5-12.5
-120125		.472-.492	—	-12-13
-125130		.492-.512	-1/2E	-12.5-13
-130140	.260	.512-.551	—	-13-14.5
-140150		.551-.591	-9/16E	-14-15.5
-150160		.591-.630	-5/8E	-15-16

Catalog Number	L1	Cutter Shank ø	Collet Model (Inch)	Collet Model (Metric)
MERPS32-030035	.244	.118-.138	ERC32-1/8E	ERC32-3-3.75
-035040		.138-.157	—	-3.5-4.25
-040045		.157-.177	—	-4-4.75
-045050		.177-.197	-3/16E	-4.5-5.25
-050055		.197-.217	—	-5-6
-055060		.217-.236	—	-5.5-6.5
-060065	.260	.236-.256	-1/4E	-6-7
-065070		.256-.276	—	-6.5-7.5
-070075		.276-.295	—	-7-8
-075080		.295-.315	-5/16E	-7.5-8.5
-080085	.264	.315-.335	—	-8-9
-085090		.335-.354	—	-8.5-9.5
-090095		.354-.375	-3/8E	-9-10
-095100		.374-.394	—	-9.5-10.5
-100105	.283	.394-.413	—	-10-11
-105110		.413-.433	—	-10.5-11.5
-110115		.433-.453	-7/16E	-11-12
-115120		.453-.472	—	-11.5-12.5
-120125		.472-.492	—	-12-13
-125130		.492-.512	-1/2E	-12.5-13.5
-130140	.287	.512-.551	—	-13-14.5
-140150		.551-.591	-9/16E	-14-15.5
-150160		.591-.630	-5/8E	-15-16.5
-160170	.307	.630-.669	—	-16-17.5
-170180		.669-.709	—	-17-18.5
-180190		.709-.748	—	-18-19.5
-190200		.748-.787	-3/4E	-19-20

• PS Ring is included

ACCESSORIES



α TAPER CLEANER

For ER COLLET CHUCKS

To maintain the accuracy of high precision collet chucks by cleaning the internal collet taper.

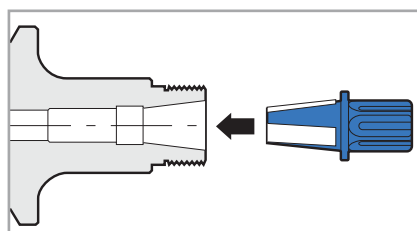

Catalog Number	Chuck Body
SC-MER11	ER11
SC-MER16	ER16
SC-MER20	ER20
SC-MER25	ER25
SC-MER32	ER32

MEGA E COLLET

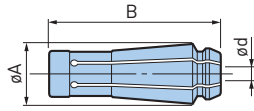

Guaranteed Max Runout

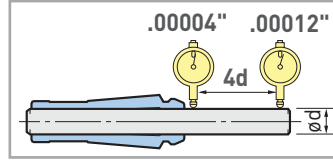

All BIG Collets are AA Grade and inspected twice for accuracy

MEGA 6E

Catalog Number	Clamping Range ød
MEC6-1/8AA	.125
-3/16AA	.187
-1/4AA	.250
-3AA	3.0mm
-4AA	4.0mm
-5AA	5.0mm
-6AA	6.0mm

øA=.44 (11.3mm) B=1.37 (34.9mm)

MEGA 8E

Catalog Number	Clamping Range ød
MEC8-1/8AA	.125
-3/16AA	.187
-1/4AA	.250
-3AA	3.0mm
-4AA	4.0mm
-5AA	5.0mm
-6AA	6.0mm
-7AA	7.0mm
-8AA	8.0mm

øA=.56 (14.1mm) B=1.55 (39.4mm)

MEGA 10E

Catalog Number	Clamping Range ød
MEC10-1/8AA	.125
-3/16AA	.187
-1/4AA	.250
-5/16AA	.312
-3/8AA	.375
-3AA	3.0mm
-4AA	4.0mm
-5AA	5.0mm
-6AA	6.0mm
-7AA	7.0mm
-8AA	8.0mm
-9AA	9.0mm
-10AA	10.0mm

øA=.67 (17.1mm) B=1.80 (45.7mm)

MEGA 13E

Catalog Number	Clamping Range ød
MEC13-1/8AA	.125
-3/16AA	.187
-1/4AA	.250
-5/16AA	.312
-3/8AA	.375
-7/16AA	.437
-1/2AA	.500
-3AA	3.0mm
-4AA	4.0mm
-5AA	5.0mm
-6AA	6.0mm
-7AA	7.0mm
-8AA	8.0mm
-9AA	9.0mm
-10AA	10.0mm
-12AA	12.0mm

øA=.81 (20.6mm) B=1.89 (47.9mm)

CAUTION

Use only a cutting tool shank with exactly the same diameter as collet bore diameter. The tolerance of the cutting tool shank must be within h7.

TOOL HOLDER ACCESSORIES A.8

α TAPER CLEANER

For MEGA E CHUCKS

To maintain the accuracy of high precision collet chucks by cleaning the internal collet taper.

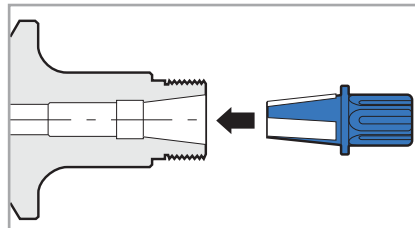

Catalog Number	Chuck Body
SC-MEC6	MEGA6E
SC-MEC8	MEGA8E
SC-MEC10	MEGA10E
SC-MEC13	MEGA13E

MEGA E NUT

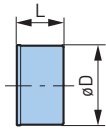

Catalog Number	øD	L	Body Type
MEN6	.98 (25mm)	.81 (20.5mm)	MEGA6E
MEN8	1.18 (30mm)	.87 (22mm)	MEGA8E
MEN10	1.38 (35mm)	.89 (22.5mm)	MEGA10E
MEN13	1.65 (42mm)	.96 (24.5mm)	MEGA13E

MEGA E PERFECT SEAL

CLAMPING RANGE: ø.118"-.472"

Unique design increases sealing performance with higher coolant pressure to create a "perfect seal".

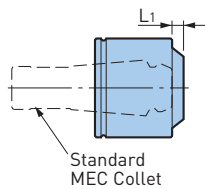

Two Way Coolant



MAX COOLANT PRESSURE
1,000
PSI

MEC6

Catalog Number	L1	Cutter Shank ø	Collet Model
EPS6-03	.220	.118	MEC6-3
-04	.205	.157	-4
-05		.197	-5
-06		.236	-6

- PS Ring is included
- For use with metric collets only, consult BIG KAISER engineering for use with inch collets

MEC8

Catalog Number	L1	Cutter Shank ø	Collet Model
EPS8-03	.252	.118	MEC8-3
-04	.236	.157	-4
-05		.197	-5
-06		.236	-6
-07	.220	.276	-7
-08		.315	-8

- PS Ring is included
- For use with metric collets only, consult BIG KAISER engineering for use with inch collets

MEC10

Catalog Number	L1	Cutter Shank ø	Collet Model
EPS10-03	.252	.118	MEC10-3
-04	.236	.157	-4
-05		.197	-5
-06		.236	-6
-07	.248	.276	-7
-08		.315	-8
-09	.224	.354	-9
-10		.394	-10

- PS Ring is included
- For use with metric collets only, consult BIG KAISER engineering for use with inch collets

MEC13

Catalog Number	L1	Cutter Shank ø	Collet Model
EPS13-03	.252	.118	MEC13-3
-04	.236	.157	-4
-05		.197	-5
-06		.236	-6
-07	.248	.276	-7
-08		.315	-8
-09	.256	.354	-9
-10		.394	-10
-11	.244	.433	-11
-12		.472	-12

- PS Ring is included
- For use with metric collets only, consult BIG KAISER engineering for use with inch collets

CAUTION

For Jet Through application by removing the PS Ring, it is recommended to use the largest clamping range of the nut corresponding to the tool shank diameter

PS RING Perfect Seal replacement seals



For MEGA PERFECT SEAL

Catalog Number	MPS Model
PS-0304	MPS□-03035, 0304
-0405	-04045, 0405
-0506	-05055, 0506
-0607	-06065, 0607
-0708	-07075, 0708

Catalog Number	MPS Model
PS-0809	MPS□-08085, 0809
-0910	-09095, 0910
-1011	-10105, 1011
-1112	-11115, 1112
-1213	-12125, 1213

Catalog Number	MPS Model
PS-1314	MPS□-1314
-1415	-1415
-1516	-1516
-1617	-1617
-1718	-1718
-1819	-1819
-1920	-1920

• 1 package contains 5 pcs. (1 size)

For MEGA ER PERFECT SEAL

Catalog Number	MERPS Model
PS-0304	MERPS□-030035, 035040
-0405	-040045, 045050
-0506	-050055, 055060
-0607	-060065, 065070
-0708	-070075, 075080

Catalog Number	MERPS Model
PS-0809	MERPS□-080085, 085090
-0910	-090095, 095100
-1011	-100105, 105110
-1112	-110115, 115120
-1213	-120125, 125130

Catalog Number	MERPS Model
PS-1314	MERPS□-130140
-1415	-140150
-1516	-150160
-1617	-160170
-1718	-170180
-1819	-180190
-1920	-190200

• 1 package contains 5 pcs. (1 size)

For MEGA E PERFECT SEAL

Catalog Number	EPS Model
PS-0304	EPS□-03
	-04
-0405	-05
-0506	-06
-0607	-07

Catalog Number	EPS Model
PS-0708	EPS□-08
-0809	-09
-0910	-10
-1011	-11
-1112	-12

• 1 package contains 5 pcs. (1 size)

For NEW BABY PERFECT SEAL

Catalog Number	BPS Model
PS-0304	BPS□-03035, 0304
-0405	-04045, 0405
-0506	-05055, 0506
-0607	-06065, 0607
-0708	-07075, 0708

Catalog Number	BPS Model
PS-0809	BPS□-08085, 0809
-0910	-09095, 0910
-1011	-10105, 1011
-1112	-11115, 1112
-1213	-12125, 1213

Catalog Number	BPS Model
PS-1314	BPS□-1314
-1415	-1415
-1516	-1516
-1617	-1617
-1718	-1718
-1819	-1819
-1920	-1920

• 1 package contains 5 pcs. (1 size)

Straight Collet Selection Guide

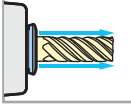
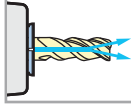
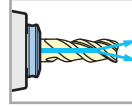
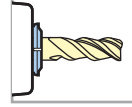
	PJC COLLET  Peripheral Coolant Supply	OCA COLLET  Coolant Through Tool Supply	PSC COLLET  Coolant Through Tool Supply	C COLLET  W/O Center Coolant
MEGA-D MEGA DOUBLE POWER CHUCK	○	○	○	○
MEGA-DS MEGA DOUBLE POWER CHUCK	○		○	○
HMC NEW Hi-POWER MILLING CHUCK	○	○	○	○
HDC HYDRAULIC CHUCK	○		○	

PSC STRAIGHT COLLET

Reduction sleeve for small diameter cutters used in NEW Hi-POWER MILLING CHUCKS, MEGA DOUBLE POWER CHUCKS & HYDRAULIC CHUCKS.

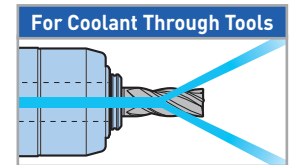
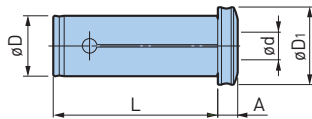

Catalog Number	Clamping Range ød	øD	L	A	D1
PSC.750-1/4	.250	.750	2.40	.30	1.06
-3/8	.375			.32	
-1/2	.500			.34	1.10
-5/8	.625				
PSC1.250-1/2	.500	1.250	2.91	.34	1.50
-5/8	.625			.36	
-3/4	.750			.37	
-7/8	.875				
-1	1.000				
PSC20-3	3.0mm	20mm	61mm	7.7mm	27mm
-4	4.0mm			7.5mm	
-5	5.0mm			8.2mm	
-6	6.0mm				
-7	7.0mm				
-8	8.0mm			8.7mm	
-9	9.0mm				
-10	10.0mm				
-11	11.0mm				
-12	12.0mm			28mm	
-13	13.0mm				
-14	14.0mm				
-15	15.0mm				
-16	16.0mm				

Catalog Number	Clamping Range ød	øD	L	A	D1
PSC32-6	6.0mm	32mm	74mm	7.5mm	38mm
-7	7.0mm			8.2mm	
-8	8.0mm				
-9	9.0mm			8.7mm	
-10	10.0mm				
-11	11.0mm				
-12	12.0mm			9.2mm	
-13	13.0mm				
-14	14.0mm				
-15	15.0mm				
-16	16.0mm			9.5mm	
-18	18.0mm				
-19	19.0mm				
-20	20.0mm				
-21	21.0mm				
-22	22.0mm				
-23	23.0mm				
-24	24.0mm				
-25	25.0mm				

- MEGA D/DS, HMC and HDC chucks allow through tool coolant when PSC collet is used
- The maximum tool insertion depth from the flange of PSC20-16 collet is 59mm

PJC STRAIGHT COLLET

Reduction sleeve for small diameter cutters used in NEW Hi-POWER MILLING CHUCKS, MEGA DOUBLE POWER CHUCKS & HYDRAULIC CHUCKS.

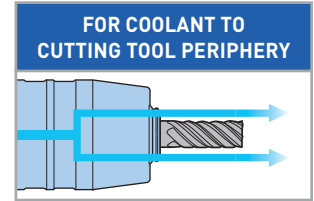
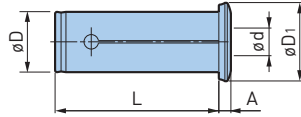

TOOL HOLDER ACCESSORIES A.8

Catalog Number	Clamping Range $\varnothing d$	$\varnothing D$	L	A	D_1
PJC.500-1/4	.250	.500	1.57	.21	.80
-3/8	.375			.22	
PJC.750-1/4	.250	.750	2.40	.21	1.06
-3/8	.375			.22	
-1/2	.500			.27	
-5/8	.625			.29	
PJC1.000-1/4	.250	1.000	2.68	.20	1.28
-3/8	.375				
-1/2	.500			.21	
-5/8	.625			.26	
PJC1.250-1/2	.500	1.250	2.91	.20	1.54
-5/8	.625				
-3/4	.750				
-7/8	.875				
-1	1.000			.21	
PJC12-6	6.0mm	12mm	40mm	5.4mm	20.4mm
-8	8.0mm			5.6mm	
-10	10mm				
PJC16-6	6.0mm	16mm	54mm	6.0mm	23mm
-8	8.0mm				
-10	10.0mm			6.3mm	
-12	12.0mm				
PJC20-3	3.0mm	20mm	61mm	5.2mm	27mm
-4	4.0mm				
-5	5.0mm				
-6	6.0mm				
-7	7.0mm			5.7mm	
-8	8.0mm				
-9	9.0mm				
-10	10.0mm				
-11	11.0mm			6.4mm	
-12	12.0mm				
-13	13.0mm			7.3mm	
-14	14.0mm				
-15	15.0mm				
-16	16.0mm				

Catalog Number	Clamping Range $\varnothing d$	$\varnothing D$	L	A	D_1
PJC25-6	6.0mm	25mm	68mm	5.0mm	32.5mm
-8	8.0mm				
-10	10.0mm				
-12	12.0mm			5.4mm	
-16	16.0mm				
-18	18.0mm				
-20	20.0mm				
PJC32-6	6.0mm	32mm	74mm	5.0mm	39mm
-8	8.0mm				
-10	10.0mm				
-12	12.0mm				
-14	14.0mm				
-16	16.0mm				
-20	20.0mm				
-25	25.0mm	5.4mm			
PJC42-16	16.0mm	42mm	83mm	5.0mm	50.5mm
-20	20.0mm				
-25	25.0mm				
-32	32.0mm				

- MEGA D/DS and HMC chucks allow jet through coolant when PJC collet is used
- The maximum tool insertion depth from the flange of PJC20-16 collet is 58mm

CAUTION ⚠

PJC.500 & PJC12 can be used only for HMC12J. Never use with HDC.

SLENDER DRIVE COLLET

Exclusive Collet for ANGLE HEAD AG90 Slender Drive

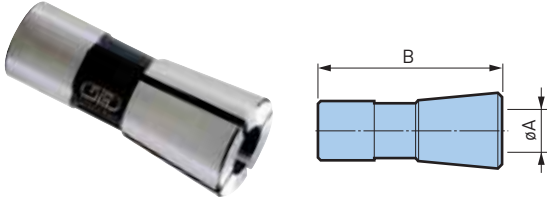

Catalog Number	ϕA	B
CA4-3	3.0mm	16.5mm
-3.5	3.5mm	
-4	4.0mm	
CA6-3	3.0mm	22mm
-4	4.0mm	
-5	5.0mm	
-6	6.0mm	

- Use only a cutting tool shank with exactly the same diameter as the collet bore diameter
- Tolerance of the cutting tool shank must be within h7

OSL REDUCTION COLLET

Exclusive Collet for Hi-JET HOLDER



Catalog Number	ϕd	ϕD
OSL1.250-.750	.750	1.250
-1.000	1.000	
OSL1.500-1.000	1.000	1.500
-1.250	1.250	



PS RING

For coolant through tools. Specially designed sealant is used inside the PSC Straight Collet.

Catalog Number	PSC Collet Model	
	Metric	Inch
PS-0304	PSC□-3,4	—
-0405	-5	—
-0506	-6	—
-0607	-7	PSC□-.250
-0708	-8	—
-0809	-9	—
-0910	-10	-.375
-1011	-11	—
-1112	-12	—
-1213	-13	-.500
-1314	-14	—
-1415	-15	—
-1516	-16	-.625
-1718	-18	—
-1819	-19	-.750
-1920	-20	—
-2021	-21	—
-2223	-22,23	—
-2324	-24	—
-2526	-25	-1.000

- 1 bag contains 5 pcs (same size)

CAUTION

The PS Ring must be replaced if damage is causing coolant to leak.

O-RING

For maintenance, common for PJC, PSC.

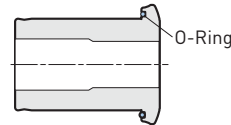

Catalog Number	Collet Model
PJC16 OR	PJC16
PJC20 OR	PJC20, PSC20, .750
PJC25 OR	PJC25, 1.000
PJC32 OR	PJC32, PSC32, 1.250
PJC42 OR	PJC42

- 2-piece set

CAUTION

Replace if the O-ring is damaged.

C COLLETS

Reduction sleeve for smaller diameter cutters used in Hi-POWER MILLING CHUCKS and MEGA DOUBLE POWER CHUCKS.

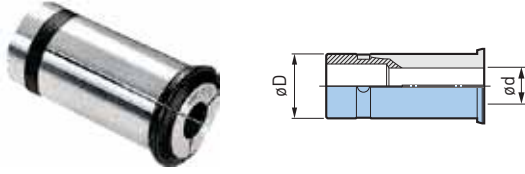

REDUCTION COLLETS

Catalog Number	Clamping Range ød	øD
C.750-1/4	.250	.750
-5/16	.312	
-3/8	.375	
-7/16	.437	
-1/2	.500	
-9/16	.562	
-5/8	.625	
C.750-6	6mm	
-8	8mm	
-10	10mm	
-12	12mm	
-14	14mm	
-16	16mm	
C1.000-1/4	.250	1.000
-3/8	.375	
-1/2	.500	
-5/8	.625	
-3/4	.750	
C1.250-1/4	.250	1.250
-5/16	.312	
-3/8	.375	
-7/16	.437	
-1/2	.500	
-9/16	.562	
-5/8	.625	
-11/16	.687	
-3/4	.750	
-13/16	.812	
-7/8	.875	
-15/16	.937	
-1	1.000	
-12	12mm	
-14	14mm	
-16	16mm	
-20	20mm	
-25	25mm	

Catalog Number	Clamping Range ød	øD
C16-6	6mm	16mm
-8	8mm	
-10	10mm	
-12	12mm	
C20-1/4	.250	20mm
-3/8	.375	
-1/2	.500	
-5/8	.625	
-6	6mm	
-8	8mm	
-10	10mm	
-12	12mm	
-14	14mm	
-16	16mm	
-18	18mm	
C25-6	6mm	25mm
-8	8mm	
-10	10mm	
-12	12mm	
-14	14mm	
-16	16mm	
-18	18mm	
-20	20mm	

Catalog Number	Clamping Range ød	øD
C32-1/4	.250	32mm
-3/8	.375	
-1/2	.500	
-5/8	.625	
-3/4	.750	
-1	1.000	
-6	6mm	
-8	8mm	
-10	10mm	
-12	12mm	
-14	14mm	
-16	16mm	
-18	18mm	
-19	19mm	
-20	20mm	
-22	22mm	
-24	24mm	
-25	25mm	
C42-6	6mm	42mm
-8	8mm	
-10	10mm	
-12	12mm	
-16	16mm	
-20	20mm	
-25	25mm	
-31	31mm	
-32	32mm	

• Collet Adjuster cannot be used with C20-16, C20-18 & C42-40

OCA COLLETS

Reduction sleeve for smaller diameter cutters used in Hi-POWER MILLING CHUCKS and MEGA DOUBLE POWER CHUCKS.

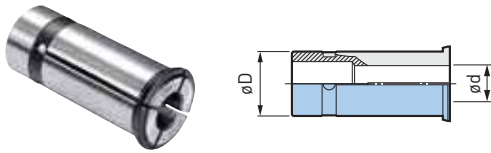

METALLIC SEALED COOLANT COLLETS

Catalog Number	Clamping Range ød	øD
OCA16-6	6mm	16mm
-8	8mm	
-10	10mm	
-12	12mm	
OCA20-6	6mm	20mm
-8	8mm	
-10	10mm	
-12	12mm	
-14	14mm	
-16	16mm	
OCA25-6	6mm	25mm
-8	8mm	
-10	10mm	
-12	12mm	
-14	14mm	
-16	16mm	
-18	18mm	
-20	20mm	
OCA32-6	6mm	32mm
-8	8mm	
-10	10mm	
-12	12mm	
-13	13mm	
-14	14mm	
-15	15mm	
-16	16mm	
-17	17mm	
-18	18mm	
-19	19mm	
-20	20mm	
-21	21mm	
-22	22mm	
-23	23mm	
-24	24mm	
-25	25mm	
-28	28mm	

Catalog Number	Clamping Range ød	øD
OCA42-6	6mm	42mm
-8	8mm	
-10	10mm	
-12	12mm	
-16	16mm	
-19	19mm	
-20	20mm	
-24	24mm	
-25	25mm	
-31	31mm	
-32	32mm	

- Capable of supplying coolant through tool
- Use with cutting tools with oil holes
- For the MEGA DS chuck use the PSC Collet

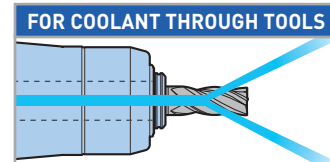

- Recommended Only for HMC(S) Type Holders

ADJUSTABLE FACE MILL ARBOR

For NEW Hi-POWER MILLING CHUCK

An arbor for mounting JIS Standard B4114 face milling cutters.

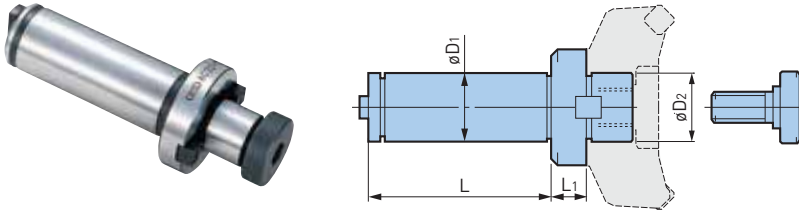

Catalog Number	ϕD_1	ϕD_2	L	L ₁	Cutter Diameter
AC32-F3	32mm	25.4mm	3.35	.61	3 (80mm)
-F4		31.75mm		.69	4 (100mm)
AC42-F3	42mm	25.4mm	4.13	.63	3 (80mm)
-F4		31.75mm		.71	4 (100mm)

- Axial Adjusting Screw is required for axial adjustment
- Use JIS B4114 face milling cutters

JACOBS TAPER ARBOR

For NEW Hi-POWER MILLING CHUCK

An arbor for mounting Jacobs taper holders such as keyless chucks.

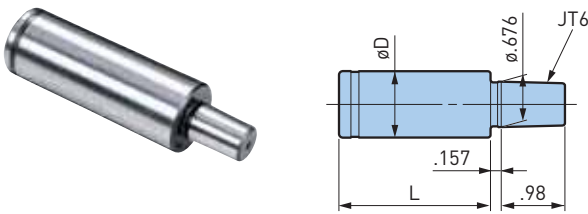

Catalog Number	ϕD	L
C20-JT6	20mm	3.15
C25-JT6	25mm	3.35
C32-JT6	32mm	3.66
C42-JT6	42mm	4.21

MORSE TAPER HOLDER

For NEW Hi-POWER MILLING CHUCK

A holder for mounting Morse taper shank drills or reamers.

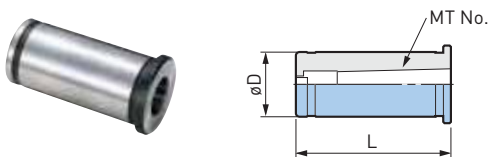

Catalog Number	ϕD	L
C20-MT1	20mm	2.36
-MT2		2.83
C25-MT1	25mm	2.36
-MT2		2.83
C32-MT1	32mm	2.34
-MT2		2.83
-MT3		3.54
C42-MT1	42mm	2.34
-MT2		2.83
-MT3		3.54
-MT4		4.49

SPANNER WRENCH

For NEW HI-POWER MILLING CHUCK

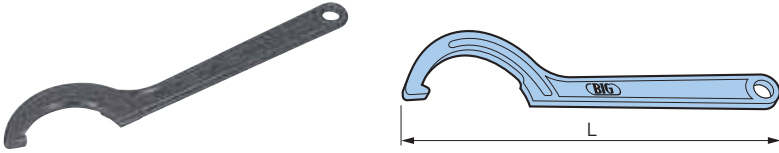

Catalog Number	Nut Diameter	L	Holder Type	
			Metric	Inch
FK31-33	1.22-1.30 (31-33mm)	6.0	HMC12J	HMC.500J
FK45-50L	1.69-1.97 (43-50mm)	9.5	HMC16S	HMC.750S
			HMC20S	
FK52-55	2.05-2.17 (52-55mm)	8.7	HMC25S(BT/BBT30)	—
FK58-62	2.28-2.44 (58-62mm)	9.4	HMC20	HMC.750
HMC25			HMC1.000	
FK58-62L		11.5	HMC25S HMC32S(BT/BBT30)	HMC1.000S
FK68-75L	2.68-2.95 (68-75mm)	12.5	HMC32S	HMC1.250S
FK80-90	3.15-3.54 (80-90mm)	11.0	HMC32	HMC1.250
FK80-90L		15.4	HMC42S	
FK92-100	3.62-3.94 (92-100mm)	11.0	HMC42	HMC1.500
			HMC50.8	
FK110-115	4.33-4.53 (110-115mm)	13.2	—	HMC2.000

MEGA WRENCH

For MEGA CHUCK Series. One-way clutch system applies tightening force to entire nut periphery evenly. Prevents wrench slippage for a safe and secure tightening operation.



Catalog Number	ød	Body Model				
		MEGA MICRO CHUCK	MEGA NEW BABY CHUCK	MEGA E CHUCK	MEGA ER GRIP	MEGA SYNCHRO
MGR10	.39 (10mm)	MEGA3S	—	—	—	—
MGR12	.47 (12mm)	MEGA4S	—	—	—	—
MGR14	.55 (14mm)	MEGA6S	—	—	—	—
MGR16	.63 (16mm)	—	—	—	—	MGT6
MGR18	.71 (18mm)	MEGA8S	—	—	—	—
MGR20	.79 (20mm)	—	MEGA6N	—	—	—
MGR20L	.79 (20mm)	—	—	—	—	MGT12
MGR25	.98 (25mm)	—	MEGA8N	MEGA6E	—	—
MGR30	1.18 (30mm)	—	MEGA10N	MEGA8E	—	—
MGR35	1.38 (35mm)	—	MEGA13N	MEGA10E	—	—
MGR42	1.65 (42mm)	—	MEGA16N	MEGA13E	—	—
MGR46	1.81 (46mm)	—	MEGA20N	—	—	—

Catalog Number	ød	Body Model				
		MEGA NEW BABY CHUCK	MEGA DOUBLE POWER CHUCK	NEW Hi- POWER MILLING CHUCK	MEGA PERFECT GRIP	MEGA ER GRIP
MGR30L	1.18 (30mm)	—	—	—	—	MEGAER16
MGR35L	1.38 (35mm)	—	—	—	—	MEGAER20
MGR42L	1.65 (42mm)	—	MEGA16(5/8")DS-□A (BCV40,BBT40, HSK-A63/F63)	—	—	MEGAER25
MGR43L	1.69 (43mm)	—	—	HMC16S	—	—
MGR46L	1.81 (46mm)	—	MEGA16DS (BBT30/50, HSK-A40/A50/A100)	—	MEGA16DPG	—
MGR50L	1.97 (50mm)	—	MEGA20(3/4")DS-□A (BCV40,BBT40, HSK-A63/F63) MEGA20(3/4")DS (BBT30, HSK-A50)	HMC20(3/4")JS	—	MEGAER32
MGR55L	2.17 (55mm)	—	—	HMC25S (BT/BBT30)	—	—
MGR59L	2.32 (59mm)	—	—	HMC25(1")JS	—	—
MGR60L	2.36 (60mm)	MEGA25N	MEGA20(3/4")DS (BCV50,BBT50, HSK-A100)	HMC20	—	—
MGR62L	2.44 (62mm)	—	MEGA25(1")DS-□A (BCV40,BBT40, HSK-A63/F63)	HMC25 HMC32S (BT/BBT30)	MEGA20(3/4")DPG	—
MGR68L	2.68 (68mm)	—	—	HMC32(1 1/4")JS	—	—
MGR70L	2.76 (70mm)	—	MEGA25(1")DS (BCV50,BBT50, HSK-A100) MEGA32(1 1/4")DS-□A (BCV40,BBT40, HSK-A63/F63)	—	—	—
MGR80L	3.15 (80mm)	—	MEGA32(1 1/4")DS (BCV50, BBT50, HSK-A100)	HMC32(1 1/4")JS	—	—
MGR85L	3.35 (85mm)	—	—	HMC42S	—	—
MGR99L	3.90 (99mm)	—	MEGA42DS	HMC42	MEGA25(1")DPG	—
MGR105L	4.13 (105mm)	—	MEGA50DS	—	MEGA32(1 1/4")DPG	—

MEGA TORQUE WRENCH

For MEGA CHUCK Series. MEGA WRENCH with torque limiter.



Catalog Number	ød	Body Model		
		MEGA MICRO	MEGA NEW BABY CHUCK	MEGA E CHUCK
MGR10TL	.39 (10mm)	MEGA3S	—	—
MGR12TL	.47 (12mm)	MEGA4S	—	—
MGR12TLS❖			—	—
MGR14TL	.55 (14mm)	MEGA6S	—	—
MGR14TLS❖			—	—
MGR18TL	.71 (18mm)	MEGA8S	—	—
MGR20TL	.79 (20mm)	—	MEGA6N	—
MGR20TLS❖		—		—
MGR25TL	.98 (25mm)	—	MEGA8N	MEGA6E
MGR25TLS❖		—		—
MGR30TL	1.18 (30mm)	—	MEGA10N	MEGA8E
MGR35TL	1.38 (35mm)	—	MEGA13N	MEGA10E
MGR42TL	1.65 (42mm)	—	MEGA16N	MEGA13E
MGR46TL	1.81 (46mm)	—	MEGA20N	—

❖ For ø3mm or smaller shank tools use TLS models

MEGA TORQUE WRENCH BODY

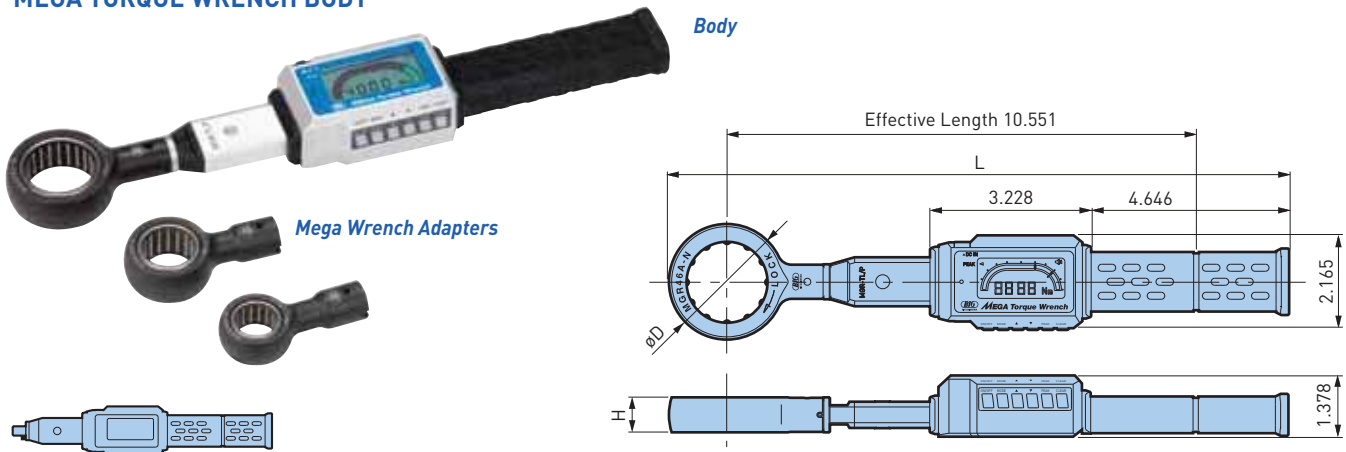

Catalog Number	MGR-TL/P
Torque Range	10-50 Nm
Minimum Read (Digit)	.01 Nm
Display	7 LCD segments 4 digits, numerical display 20 LCD segments bar graph
Basic Function	Peak hold Tightening completion signal beep emission & vibration Auto power-off (5 minutes)
Power Supply	Built-in lithium battery (Approx. 500 recharges)
Operations Per Charge	4,000 tightening operations per full charge
Recharging Time	Approx. 3 hours (Using the exclusive AC adapter)
Operating Temperature	32° F - 104° F (Without dew condensing)
Weight	.64 lbs (Torque Wrench Body, excluding Mega Wrench Adapter and AC Adapter)

MEGA TORQUE WRENCH ADAPTER (OPTIONAL)



Catalog Number	Overall Length L	øD	H	Weight (lbs.)	Suitable Collet Chuck	
					MEGA NEW BABY CHUCK	MEGA E CHUCK
MGR20A-N	13.976	1.417	.630	.29	MEGA6N	—
MGR25A-N	14.134	1.732	.787	.40	MEGA8N	MEGA6E
MGR30A-N	14.252	1.969	.787	.49	MEGA10N	MEGA8E
MGR35A-N	13.350	2.165	.787	.51	MEGA13N	MEGA10E
MGR42A-N	14.488	2.441	.787	.55	MEGA16N	MEGA13E
MGR46A-N	14.567	2.598	.787	.60	MEGA20N	—

MEGA TORQUE WRENCH SET

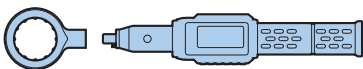

Catalog Number	Set Contents
SMGR-TL/P	1x Body 6x Mega Wrench Adapters (MGR20A-N through MGR46A-N)



EXCLUSIVE STORAGE CASE

Easy to carry and safely store the equipment. Molds for (1) Body and (6) Mega Wrench Adapters. Standard accessory for the body (MGR-TL/P) and set (SMGR-TL/P) models.

Q WIPER CLEANER

Perfect for HYDRAULIC CHUCKS and SHRINK FIT HOLDERS

Easy cleaning of smaller cylindrical bores by simply inserting and removing before cutting tool insertion.

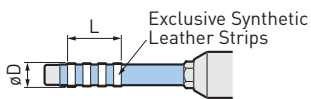

Fig. 1

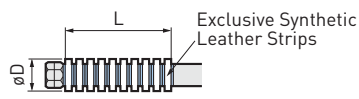

Fig. 2

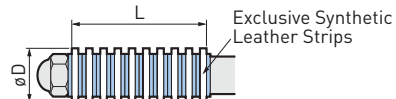

Fig. 3

Catalog Number	Fig.	øD
AWC1/4	1	.250
AWC5/16	2	.312
AWC3/8		.375
AWC7/16		.437
AWC1/2		.500
AWC9/16	3	.562
AWC3		3mm
AWC4		4mm
AWC5		5mm
AWC6		6mm
AWC7		7mm
AWC8		8mm
AWC9		9mm
AWC10		10mm
AWC11		11mm
AWC12		12mm



TK CLEANER

Perfect for HYDRAULIC CHUCKS, MILLING CHUCKS and SHRINK FIT HOLDERS

It is very difficult to remove oil and chips stuck to clamping bores, even with a wiping cloth or air spray. TK Cleaner perfectly cleans the clamping bore of a tool holder in a very simple manner to maintain the high performance of tool holders.

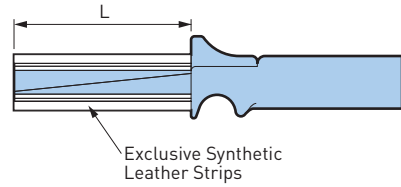

Catalog Number	Bore ϕ (metric)	Bore ϕ (inch)	Cleaning Length L	Leather Strip Qty.
TKC13	13mm	.500	2.36	2
TKC14	14mm	—		
TKC15	15mm	—		
TKC16	16mm	.625	2.76	
TKC18	18mm	—		
TKC20	20mm	.750		
TKC25	25mm	1.000	3.15	3
TKC32	32mm	1.250	3.94	4
TKC40	40mm	—		
TKC42	42mm	—		

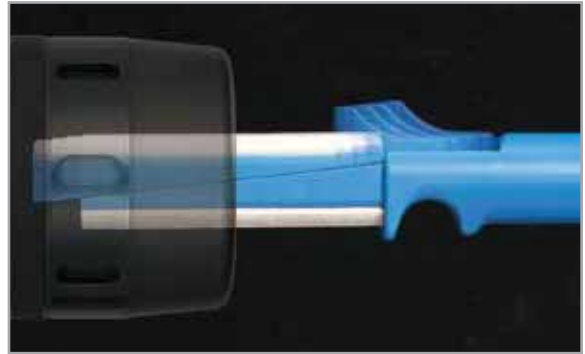

TOOL HOLDER ACCESSORIES A.8

How to Use

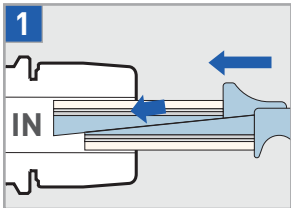

Slide the upper section forward to reduce diameter and insert in the clamping bore.

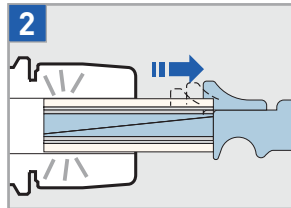

Spring action draws back the sliding section when released so the cleaning strips contact the bore surface.

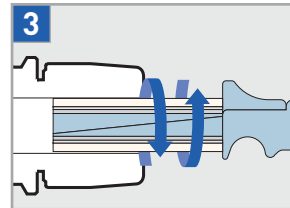

Rotate and remove the TK Cleaner to clear oil and particles.

GRIP BAR

For HYDRAULIC CHUCK
For confirming gripping force.



Catalog Number	Chuck Bore	Catalog Number	Chuck Bore
TSB3	3	TSB15	15
4	4	16	16
5	5	18	18
6	6	19	19
7	7	20	20
8	8	22	22
9	9	24	24
10	10	25	25
11	11	28	28
12	12	31	31
13	13	32	32
14	14	42	42

• For details of usage, refer to the Hydraulic Chuck operation manual

SCREWS

For HYDRAULIC CHUCK

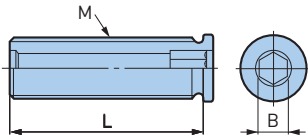

Fig. 1

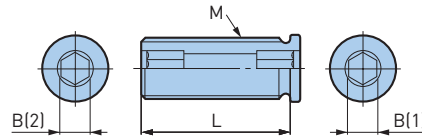
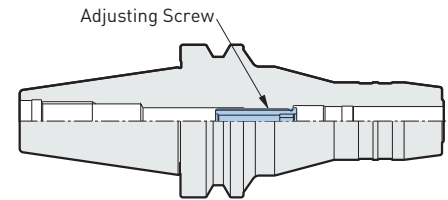

Fig. 2



Catalog Number	Fig.	M (Left Hand Thread)	L	B
HDA6-05013	1	M5x.8	.51	2.5mm
-05020			.79	
-05032			1.26	
HDA8-06013		M6x1	.51	3mm
-06020			.79	
-06032			1.26	
HDA10-08015		M8x1	.59	4mm
-08032			1.26	
HDA12-10010			.39	
-10025		.98		
-10032		1.26		
HDA16-12015		M12x1	.59	6mm
-12030			1.18	
-12037			1.46	
HDA20-16015		M16x1	.59	6mm
HDA25-16033			1.30	
-16039	1.54			

Catalog Number	Fig.	M (Left Hand Thread)	L	B
HDA6-05013W	2	M5x.8	.51	2.5mm
-05020W			.79	
-05032W			1.26	
HDA8-06013W		M6x1	.51	3mm
-06020W			.79	
-06032W			1.26	
HDA10-08015W		M8x1	.59	4mm
-08032W			1.26	
HDA12-10025W			.98	
-10032W		1.26		
HDA16-12015W		M12x1	.59	4mm
-12030W			1.18	
-12037W			1.46	
HDA20-16015W		M16x1	.59	4mm
HDA25-16033W			1.18	
-16039W			1.46	

ANSI STANDARD

AVAILABLE IN
SHORT - EXTRA LONG
1.25", 3", 4", 6" & 8"

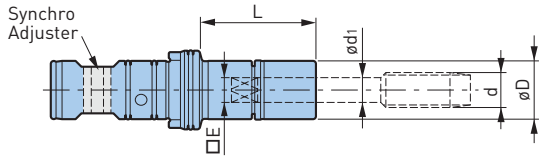

MGT6—INCH STYLE (øD=.63, 16mm)

Catalog Number	Tapping Range d	ød1	□E	L
MGT6-No.6-1.25	No.2-6	.141	.110	1.25
-3				3.00
-4				4.00
-6				6.00
-No.8-1.25	No.8	.168	.131	1.25
-3				3.00
-4				4.00
-6	6.00			
-No.10-1.25	No.10	.194	.152	1.25
-3				3.00
-4				4.00
-6				6.00
-8	8.00			
-No.12-1.25	No.12	.220	.165	1.25
-3				3.00
-4				4.00
-6				6.00
-8				8.00

• Nut is included, wrench must be ordered separately

MGT12—INCH STYLE (øD=.79, 20mm)

Catalog Number	Tapping Range d	ød1	□E	L
MGT12-AU1/4-1.25	AU1/4	.255	.191	1.25
-3				3.00
-4				4.00
-6				6.00
-8	8.00			
-AU5/16-1.25	AU5/16	.318	.238	1.25
-3				3.00
-4				4.00
-6				6.00
-8	8.00			
-AU7/16-1.25	AU7/16	.323	.242	1.25
-3				3.00
-4				4.00
-6				6.00
-8	8.00			

• Nut is included, wrench must be ordered separately

TOOL HOLDER ACCESSORIES A.8

ACCESSORIES



MGT 20—INCH STYLE (øD=1.18, 30mm)

Catalog Number	Tapping Range d	ød1	□E	L
MGT20-AU1/2-1.5	AU1/2	.367	.275	1.50
-3.5				3.50
-4.5				4.50
-6				6.00
-AU3/8-1.5	AU3/8	.381	.286	1.50
-3.5				3.50
-4.5				4.50
-6				6.00
-AU9/16-1.5	AU9/16	.429	.322	1.50
-3.5				3.50
-4.5				4.50
-6				6.00
-AU5/8-1.5	AU5/8	.480	.360	1.50
-3.5				3.50
-4.5				4.50
-6				6.00
-AU11/16-1.5	AU11/16	.542	.406	1.50
-3.5				3.50
-4.5				4.50
-6				6.00
-AU3/4-1.5	AU3/4	.590	.442	1.50
-3.5				3.50
-4.5				4.50
-6				6.00
-AP1/8-1.5	AP1/8	.4375	.328	1.50
-3.5				3.50
-4.5				4.50
-6				6.00
-AP1/4-1.5	AP1/4	.5625	.421	1.50
-3.5				3.50
-4.5				4.50
-6				6.00

• Nut is included, wrench must be ordered separately



A.8 TOOL HOLDER ACCESSORIES

ACCESSORIES



JIS STANDARD



AVAILABLE IN
SHORT - EXTRA LONG
30mm, 70mm, 100mm,
150mm & 200mm

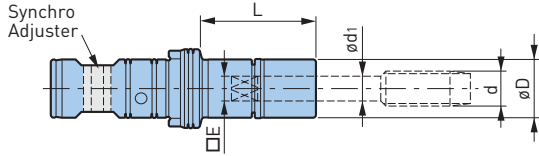

MGT6—METRIC STYLE (øD=16mm)

Catalog Number	Tapping Range d			ød1	□E	L
	Metric	Pipe	Unify			
MGT6-M2-30	M2	—	JIS No.3 JIS No.4	3.0	2.5	30
-70						70
-100						100
-150						150
-M3-30	M3	—	JIS No.5 JIS No.6	4.0	3.2	30
-70						70
-100						100
-150						150
-M4-30	M4	—	JIS No.8	5.0	4.0	30
-70						70
-100						100
-150						150
-M5-30	M5	—	JIS No.10 JIS No.12	5.5	4.5	30
-70						70
-100						100
-150						150
-M6,U1/4-30	M6	—	JIS U1/4	6.0	4.5	30
-70						70
-100						100
-150						150
-200						200

- Nut is included, wrench must be ordered separately
- All dimensions shown in millimeters

MGT12—METRIC STYLE (øD=20mm)

Catalog Number	Tapping Range d			ød1	□E	L
	Metric	Pipe	Unify			
MGT12-M6,U1/4-30	M6	—	JIS U1/4	6.0	4.5	30
-70						70
-100						100
-150						150
-200						200
U5/16-30	—	—	JIS U5/16	6.1	5.0	30
-70						70
-100						100
-150						150
-200						200
-M8-30	M8	—	—	6.2	5.0	30
-70						70
-100						100
-150						150
-200						200
-M10,U3/8-30	M10	—	JIS U3/8	7.0	5.5	30
-70						70
-100						100
-150						150
-200						200
U7/16,P1/8-30	—	JIS P1/8	JIS U7/16	8.0	6.0	30
-70						70
-100						100
-150						150
-200						200
-M12-30	M12	—	—	8.5	6.5	30
-70						70
-100						100
-150						150
-200						200

- Nut is included, wrench must be ordered separately
- All dimensions shown in inches

ACCESSORIES



MGT20—METRIC STYLE (øD=30mm)

Catalog Number	Tapping Range d			ød1	□E	L
	Metric	Pipe	Unify			
MGT20-M12-35	M12	—	—	8.5	6.5	35
-85						85
-115						115
-150						150
-U1/2-35						—
-85	85					
-115	115					
-150	150					
-M14,U9/16-35	M14	—	JIS U9/16	10.5	8.0	
-85						85
-115						115
-150						150
-P1/4-35						—
-85	85					
-115	115					
-150	150					
-U5/8-35	—	—	JIS U5/8	12.0	9.0	
-85						85
-115						115
-150						150
-M16-35						M16
-85	85					
-115	115					
-150	150					
-M18,U3/4-35	M18	—	JIS U3/4	14.0	11.0	
-85						85
-115						115
-150						150
-P3/8-35						M18
-85	85					
-115	115					
-150	150					
-M20-35	M20	—	—	15.0	12.0	
-85						85
-115						115
-150						150

- Nut is included, wrench must be ordered separately
- All dimensions shown in millimeters

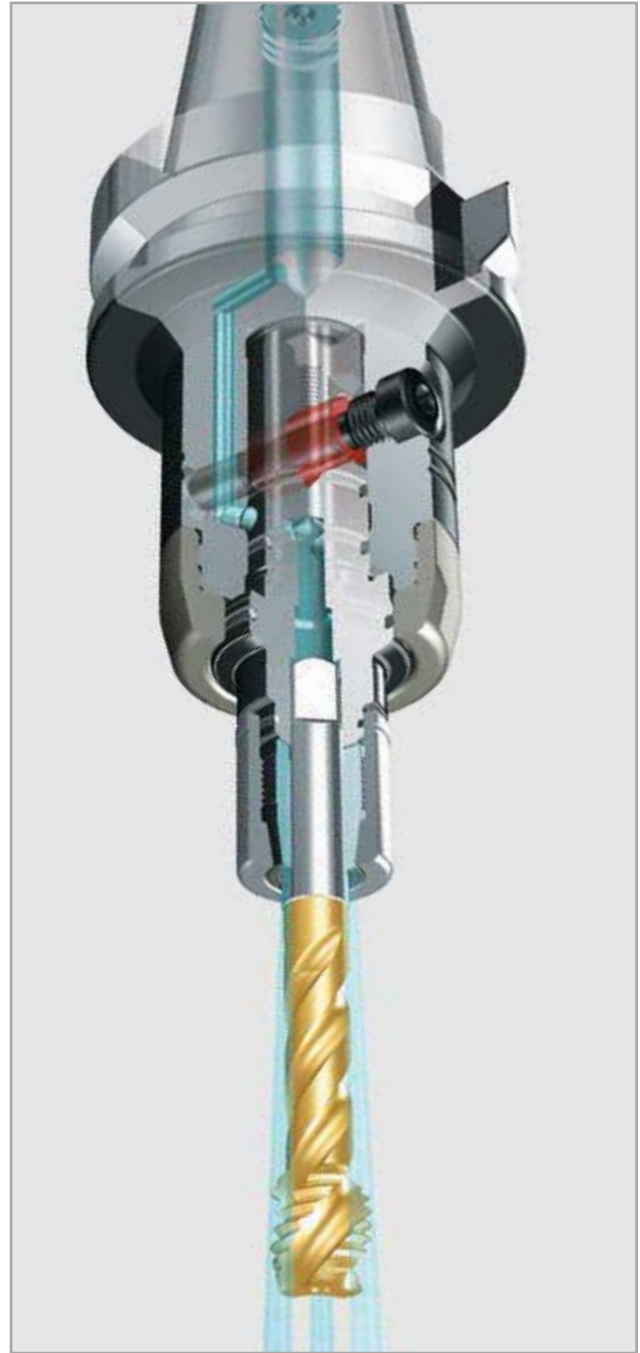

ACCESSORIES



DIN & ISO STANDARD



AVAILABLE IN
SHORT - EXTRA LONG
30mm, 70mm, 100mm,
150mm & 200mm

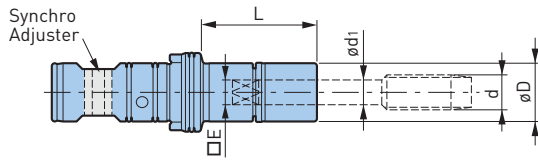

MGT6—METRIC STYLE (øD=16mm)

Catalog Number	Tapping Range d					ød1	□E	L
	DIN371	DIN376	DIN353	ISO529	ISO2284			
MGT6-031025-30								30
-70								70
-100	—	—	—	M3	—	3.15	2.5	100
-150								150
-035027-30								30
-70								70
-100	M3	M5	—	—	—	3.5	2.7	100
-150								150
-040032-30								30
-70								70
-100	—	—	—	M4	—	4.0	3.15	100
-150								150
-045034-30								30
-70								70
-100	M4	M6	—	—	—	4.5	3.4	100
-150								150
-050040-30								30
-70								70
-100	—	—	—	M5	—	5.0	4.0	100
-150								150
-200								200
-060049-30								30
-70								70
-100	M5 M6	M8	—	—	—	6.0	4.9	100
-150								150
-200								200

- Nut is included, wrench must be ordered separately
- All dimensions shown in millimeters

ACCESSORIES



MGT12—METRIC STYLE (øD=20mm)

Catalog Number	Tapping Range d					ød1	□E	L
	DIN371	DIN376	DIN353	ISO529	ISO2284			
MGT12-060049-30	M5 M6	M8	—	—	—	6.0	4.9	30
-70								70
-100								100
-150								150
-200								200
-063050-30	—	—	—	M6	—	6.3	5.0	30
-70								70
-100								100
-150								150
-200								200
-070055-30	—	M10	1/8	—	—	7.0	5.5	30
-70								70
-100								100
-150								150
-200								200
-080063-30	M8	—	—	M8	1/8	8.0	6.3	30
-70								70
-100								100
-150								150
-200								200
-090071-30	—	M12	—	M12	—	9.0	7.1	30
-70								70
-100								100
-150								150
-200								200

- Nut is included, wrench must be ordered separately
- All dimensions shown in millimeters

ACCESSORIES



DIN & ISO STANDARD



AVAILABLE IN
SHORT 4", LONG 6" &
EXTRA LONG 8"

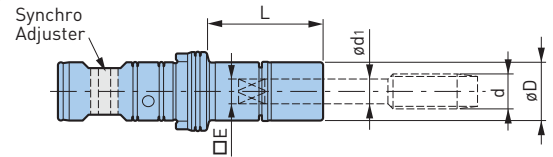

MGT20—METRIC STYLE (øD=30mm)

Catalog Number	Tapping Range d					ød1	□E	L
	DIN371	DIN376	DIN353	ISO529	ISO2284			
MGT20-090071-35								35
-85								85
-115	—	M12	—	M12	—	9.0	7.1	115
-150								150
-100080-35								35
-85	M10	—	—	M10	1/4	10.0	8.0	85
-115								115
-150								150
-110090-35								35
-85	—	M14	1/4	—	—	11.0	9.0	85
-115								115
-150								150
-112090-35								35
-85	—	—	—	M14	—	11.2	9.0	85
-115								115
-150								150
-120090-35								35
-85	—	M16	3/8	—	—	12.0	9.0	85
-115								115
-150								150
-125100-35								35
-85	—	—	—	M16	3/8	12.5	10.0	85
-115								115
-150								150
-140110-35								35
-85	—	M18	—	—	—	14.0	11.0	85
-115								115
-150								150
-140112-35								35
-85	—	—	—	M18 M20	—	14.0	11.2	85
-115								115
-150								150
-160120-35								35
-150	—	M20	1/2	—	—	16.0	12.0	150

- Nut is included, wrench must be ordered separately
- All dimensions shown in millimeters

ACCESSORIES



MGT SET SCREW

Secures the Tap Holder Into the Body.

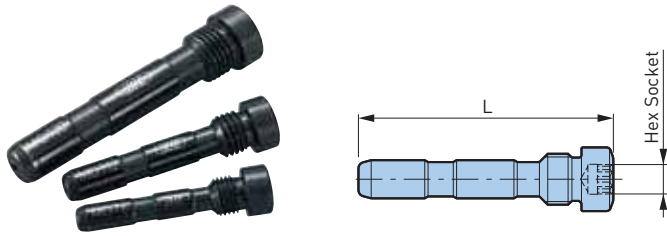

Catalog Number	Hex Socket Size	L	Body
MGT6SS	4mm	35mm	MGT6
MGT12SS	4mm	40mm	MGT12
MGT20SS	5mm	53mm	MGT20

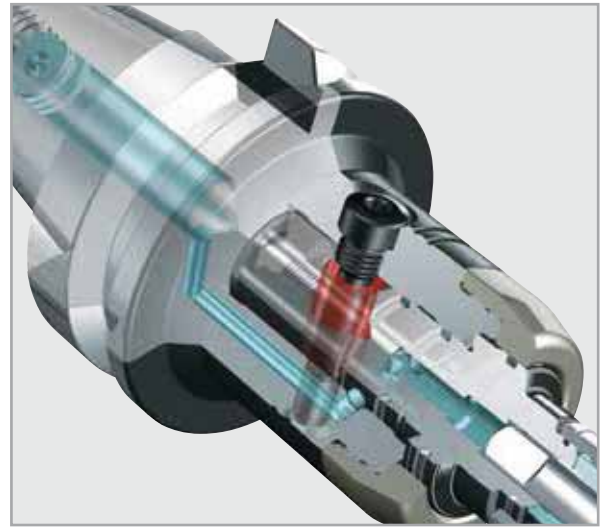

SYNCHRO ADJUSTER—SOFT TYPE

Replaceable Bushing in the Tap Holder

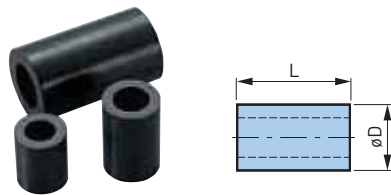

Catalog Number	øD	L	Body
MGT6SA	9mm	11mm	MGT6
MGT12SA	10mm	15mm	MGT12
MGT20SA	14mm	24mm	MGT20

- Sold in packages of 5 pcs.
- Soft type is included in our standard MEGA SYNCHRO tapping holders

SYNCHRO ADJUSTER—HARD TYPE

Replaceable Bushing in the Tap Holder for Eccentric Relief Taps

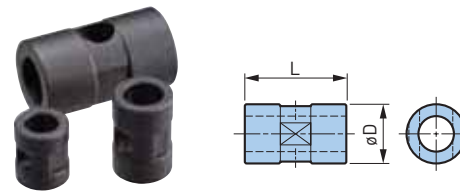

Catalog Number	øD	L	Body
MGT6SA	9mm	11mm	MGT6
MGT12SA	10mm	15mm	MGT12
MGT20SA	14mm	24mm	MGT20

- Sold in packages of 1 pcs.

NUT

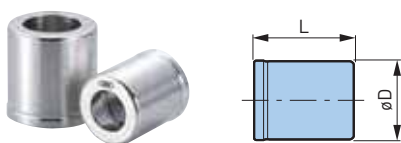

Catalog Number	øD	L	Tap Holder
MGN6T	.63 [16mm]	.75 [19mm]	MGT6
MGN12T	.79 [20mm]	.83 [21mm]	MGT12
MGN20T	1.18 [30mm]	.94 [24mm]	MGT20

O-RING

For MEGA SYNCHRO Tapping Holder

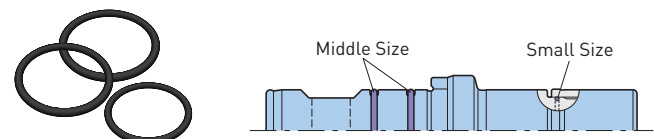

Catalog Number	Tap Holder
MGT60R	MGT6-d-□
MGT120R	MGT12-d-□
MGT200R	MGT20-d-□

- Set includes 1 small & 2 middle sizes

DIN, ISO, ANSI & JIS STANDARD

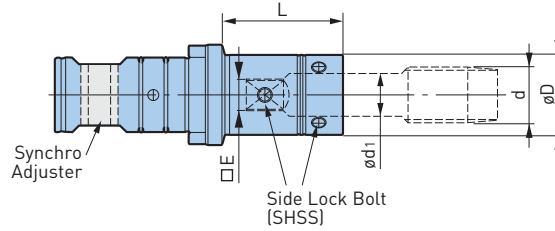

MGT36

Inch Style ANSI Standard

Catalog Number	Tapping Range d	ød1	□E	øD	L
MGT36-AU13/16-2.5	AU13/16	.652	.489	1.24	2.50
-AU7/8-2.5	AU7/8	.697	.523	1.34	
-AU15/16-2.5	AU15/16	.760	.570	1.57	
-AU1-2.5	AU1	.800	.600	1.62	
-AU1.1/8-2.5	AU1-1/8	.896	.672	1.69	
-AU1.1/4-2.5	AU1-1/4	1.021	.766	1.97	
-AU1.3/8-2.5	AU1-3/8	1.108	.831	2.09	
-AU1.1/2-3	AU1-1/2	1.50	1.125	2.20	3.00
-AP3/8-2.5	AP3/8	.700	.531	1.34	2.50
-AP1/2-2.5	AP1/2	.688	.515	1.34	
-AP3/4-2.5	AP3/4	.906	.679	1.69	
-AP1-2.5	AP1	1.125	.843	2.09	

Metric Style JIS Standard

Catalog Number	Tapping Range d	ød1	□E	øD	L
MGT36-M20-65	M20	15mm	12mm	32mm	65mm
-M22-65	M22	17mm	13mm	34mm	
-M24-65	M24	19mm	15mm	39mm	
-M27-65	M27	20mm	15mm	40mm	
-M30-65	M30	23mm	17mm	43mm	
-M33-65	M33	25mm	19mm	49mm	
-M36-65	M36	28mm	21mm	52mm	
-P1/2-65	P1/2	18mm	14mm	35mm	
-P3/4-65	P3/4	23mm	17mm	43mm	
-P1-65	P1	26mm	21mm	50mm	

Metric Style DIN & ISO Standard

Catalog Number	Tapping Range d				ød1	□E	øD	L
	DIN376	DIN353	ISO529	ISO2284				
MGT36-180145-65	M22,M24	5/8	—	—	18mm	14.5mm	35mm	65mm
-200160-65	M27	3/4	M27,M30	3/4	20mm	16mm	40mm	
-220180-65	M30	7/8	—	—	22mm	18mm	42mm	
-250200-65	M33	1	M36	1	25mm	20mm	49mm	
-280220-65	M36	—	—	—	28mm	22mm	52mm	

• Adjusting screw is included

CAUTION

Tap with eccentric thread relief, having no margin on tap periphery, may cause oversize threads. In such case, tap with con-eccentric thread relief is recommended.

ADJUST SCREW

Aids Easy Adjustment of Tap Projection Length.

- Adjustment of tap projection length (adjustable amount: 3mm)
- Coolant supply adjustable in 2 ways by reversing the Adjust Screw

Tap without hole

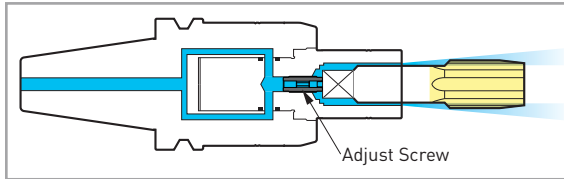

Tap with hole

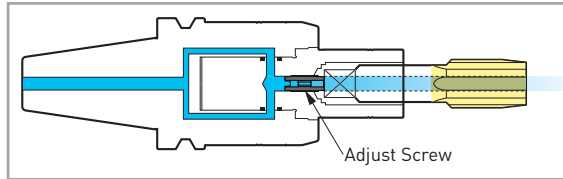

Catalog Number	Tap Holder
MGT36AJ	MGT36

SIDE LOCK BOLT SET

Spare Locking Screw to Clamp a Tap.

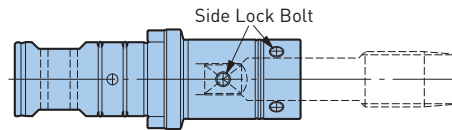

Catalog Number	ANSI Tap Holder Model	JIS Tap Holder Model	Bolt Size
MGT36SL6	MGT36-AU7/8-2.5	MGT36-M20-65	M6x8L (x4) + M6x10L (x2)
	MGT36-AP3/8-2.5	MGT36-M22,U7/8-65	
	MGT36-AP1/2-2.5	MGT36-P1/2-65	
MGT36SL8	MGT36-AU1-2.5	MGT36-M24-65	M8x10L (x4) + M8x12L (x2)
	MGT36-AU1.1/8-2.5	MGT36-M27,U1-65	
	MGT36-AP3/4-2.5	MGT36-M30-65	
MGT36SL10	MGT36-AU1.1/4-2.5	MGT36-P3/4-65	M10x12L (x4) + M10x14L (x2)
	MGT36-AU1.3/8-2.5	MGT36-M33-65	
	MGT36-AP1-2.5	MGT36-M36-65	
	—	MGT36-P1-65	

SET SCREW



Catalog Number	Tap Holder
MGT36SS	MGT36

SYNCHRO ADJUSTER



Catalog Number	Tap Holder
MGT36SA	MGT36

- Sold in packages of 5 pcs.

O-RING SET



Catalog Number	Tap Holder
MGT36OR	MGT36

AG35 ADAPTERS

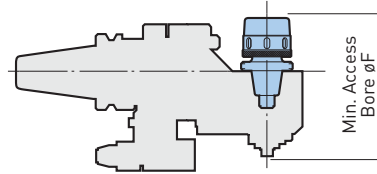
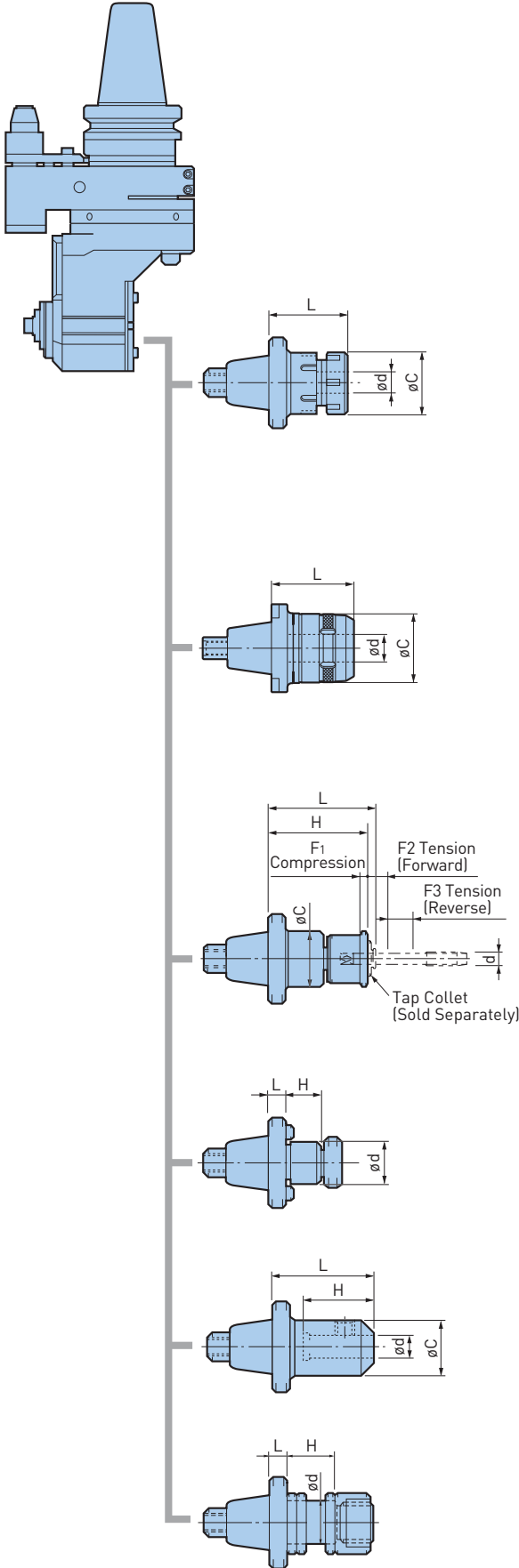

ϕF = Minimum Bore Size that an AG35 Adapter Can Fit Into, Excluding the Cutting Tool

NEW BABY CHUCK

Catalog Number	ϕd	L	ϕC	ϕF	Weight (lbs.)
AG35-NBS10	.059-.394	1.850	1.181	6.378	1.3
-NBS13	.098-.512	2.126	1.378	6.614	1.5
-NBS16	.098-.630		1.654	6.693	1.8
-NBS20	.098-.787		1.811	6.693	2.0

ACCESSORIES



NEW HI-POWER MILLING CHUCK

Catalog Number	ϕd	L	ϕC	ϕF	Wrench	Weight (lbs.)
AG35-HMC.750S	.750	2.362	1.970	7.008	FK45-50L	3.3

ACCESSORIES



AUTO TAPPER TYPE B

Catalog Number	ϕd	L	ϕC	H	F1	F2	F3	Weight (lbs.)
AG35-ATB12E	No. 6-U1/2	3.150	1.594	2.835	.020	.197	.157	2.2
-ATB20E	U3/8-U3/4	4.528	2.264	4.035		.256	.197	3.7

- Tap collets with torque control or positive drive available upon request

SHELL MILL ADAPTER

Catalog Number	ϕd	L	H	Weight (lbs.)
AG35-SM1.000-20	1.000	.787	.689	2.2

END MILL ADAPTER

Catalog Number	ϕd	L	ϕC	H	ϕF	Weight (lbs.)
AG35-EM.750	.750	3.248	1.750	3.880	7.756	3.0

STUB ARBOR

Catalog Number	ϕd	L	H	Weight (lbs.)
AG35-SA1.000	1.000	.394	1.181	2.8

SET UP INFORMATION

Preparing the Stop Block

For ANGLE HEADS. The ANGLE HEAD utilizes a Locating Pin that engages with the Stop Block, which is mounted to the machine spindle to prevent radial movement of the ANGLE HEAD during operation. Therefore, it is necessary to use a Stop Block with the proper dimensions to match the Locating Pin of the ANGLE HEAD. Please contact a BIG KAISER agent if using an existing Stop Block.



STANDARD SETUP OF THE LOCATING PIN

Please note that the "S" dimension and Fixed Length "A" are not adjustable by the user. If the standard dimensional values shown below are not suitable for your machine, please contact a BIG KAISER agent.

"S" Dimension

The distance from the centerline of the ANGLE HEAD spindle to the centerline of the Locating Pin.

Fixed Length "A"

The axial distance from the gage line to the top of the Locating Pin, when the Locating Pin is properly engaged in the Stop Block.

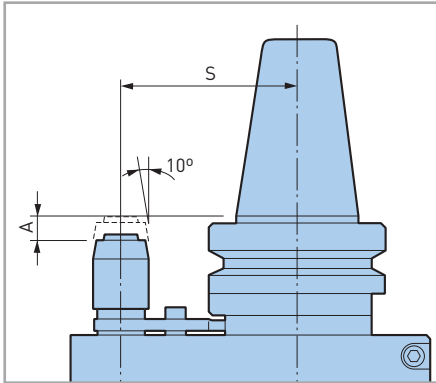

Catalog Number	Dimension S	Fixed Length A
BCV/BBT40	2.559	.315
BCV/BBT50	4.331	.236

STOP BLOCK DIMENSIONS

Please order a Stop Block from the machine tool builder. Refer to the following diagrams for the proper Stop Block groove dimensions and configurations for use with an ANGLE HEAD.

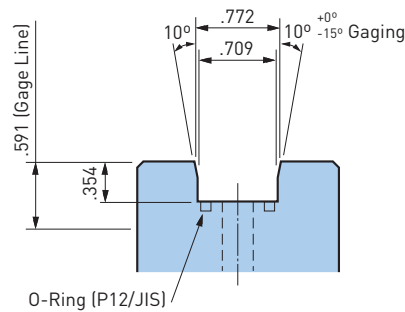

S=2.559" (65mm) / S=3.150" (80mm)

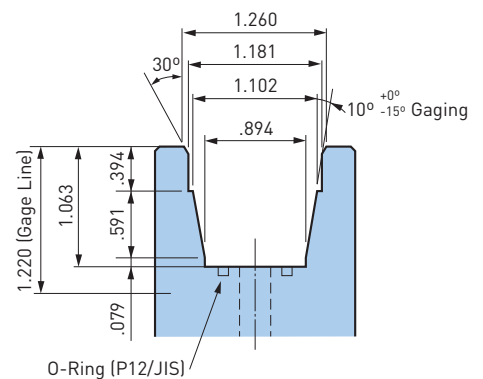

S=4.331" (110mm)

CAUTION

For a BCV50/BBT50 unit with an 3.150 "S" dimension, please use the Stop Block dimensions for BCV40/BBT40, as the Locating Pin dimension differs from that of a standard unit with a 4.331 "S" dimension.

SEMI-FINISHED STOP BLOCK

A semi-finished Stop Block has the proper groove form for use with AIR POWER SPINDLE, HIGH SPINDLE and Hi-JET HOLDER, as well as additional material to allow the customer to machine the block to the correct height.

If a pre-made Stop Block is unobtainable from the machine tool builder, a semi-finished Stop Block can be used. Please consult with the machine tool builder for selection, machining, and mounting of the semi-finished Stop Block.

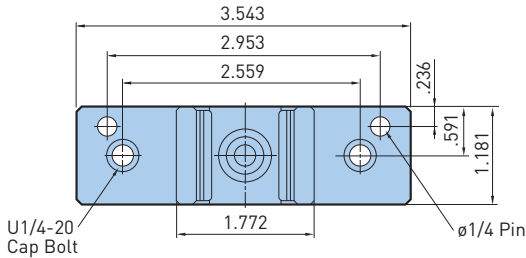

ANGLE HEADS (S=4.331)

Catalog Number
SB-G/E

- Area marked ■ indicates heat treatment (HRC45-50), all other surfaces can be milled
- Adjustment to the required height by milling the base
- Fix the stop block by inserting two dowel pins (ø1/4)

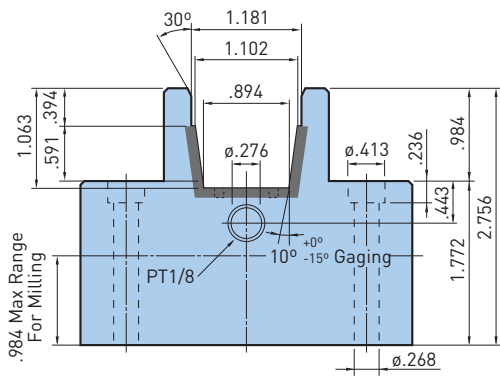

TOOL HOLDER ACCESSORIES A.8

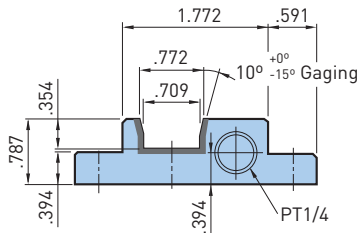
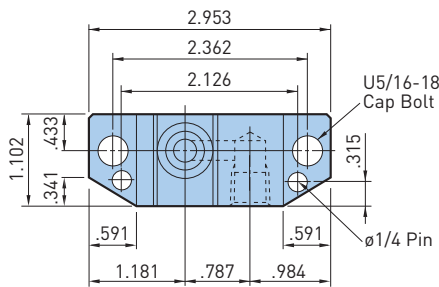

PROFIT MAKER (S=2.559, 3.150)

Catalog Number
SB-F

- Area marked ■ indicates heat treatment (HRC45-50), all other surfaces can be milled
- Fix the stop block by inserting two dowel pins (ø1/4)
- Stop Block SB-F is not height-adjustable

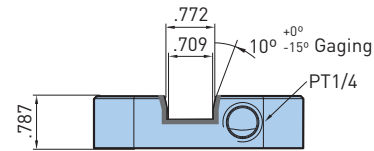
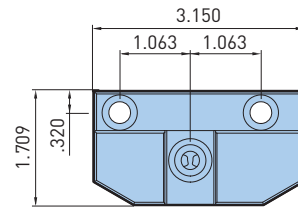

PROFIT MAKER

Catalog Number
SB-H40

- Area marked ■ indicates heat treatment (HRC45-50), all other surfaces can be milled
- For use with most Haas 40 taper machines

SET UP INFORMATION

Preparing the Locating Pin and Stop Block

For AIR POWER SPINDLE, HIGH SPINDLE & Hi-JET HOLDER. The AIR POWER SPINDLE, HIGH SPINDLE and Hi-JET HOLDER utilize a Locating Pin that engages with the Stop Block, which is mounted to the machine spindle. Please refer to the following instructions to select/adjust the Locating Pin, and to prepare it for the Stop Block.

STANDARD SETUP OF THE LOCATING PIN

"S" Dimension

The distance from the centerline of the holder to the centerline of the Locating Pin. Please note that this dimension is not adjustable by the user.

Fixed Length "A"

The axial distance from the gage line of the spindle to the bottom of the groove on the Stop Block. This dimension is adjustable by the user. Three (3) Locating Pin models are available: LP-A, LP-B, and LP-C. Each Locating Pin is adjustable to provide a different range of Fixed Length "A", as shown in the tables below. Please specify the required Fixed Length "A" when ordering. Otherwise, it will be delivered set at the standard, .236.

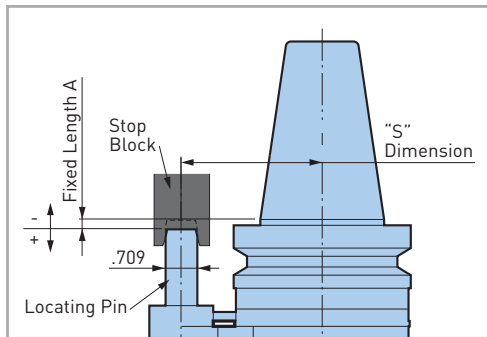

Catalog Number	"S" Dimension
BCV/CV/BBT40	2.559
BCV/CV/BBT50	3.150

For HIGH SPINDLE/AIR POWER SPINDLE

Catalog Number	BCV40	BCV50	BBT40	BBT50
LP-A	-.354 / +.236	-.157 / +.433	-.945 / -.354	-.354 / +.236
LP-B	+.236 / +.827	+.433 / +.1.024	-.354 / +.236	+.236 / +.827
LP-C	+.827 / +1.417	+1.024 / +1.614	+.236 / +.827	+.827 / +1.417

• Models marked ■ indicates adjustable range of the standard setup

For Hi-JET HOLDER

Catalog Number	CV/BT40	CV/BT50	CV40-OSL1.250	CV50-OSL2.000	BT50-OSL2.000
LP-A	-.236 / +.354	-.354 / +.236	-.197 / +.394	-.079 / +.512	+.118 / +.709
LP-B	+.354 / +.945	+.236 / +.827	+.394 / +.984	+.512 / +1.102	+.709 / +.1.299
LP-C	+.945 / +1.535	+.827 / +1.417	+.984 / +1.575	+1.102 / +1.535	+1.299 / +1.535

• Models marked ■ indicates adjustable range of the standard setup

AIR FILTERING TURBINE DRIVE

For RBX

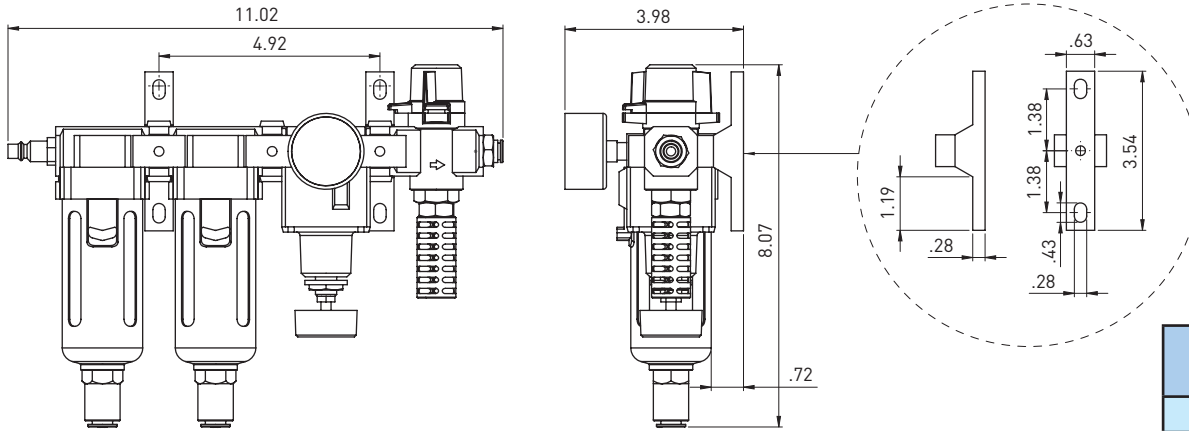
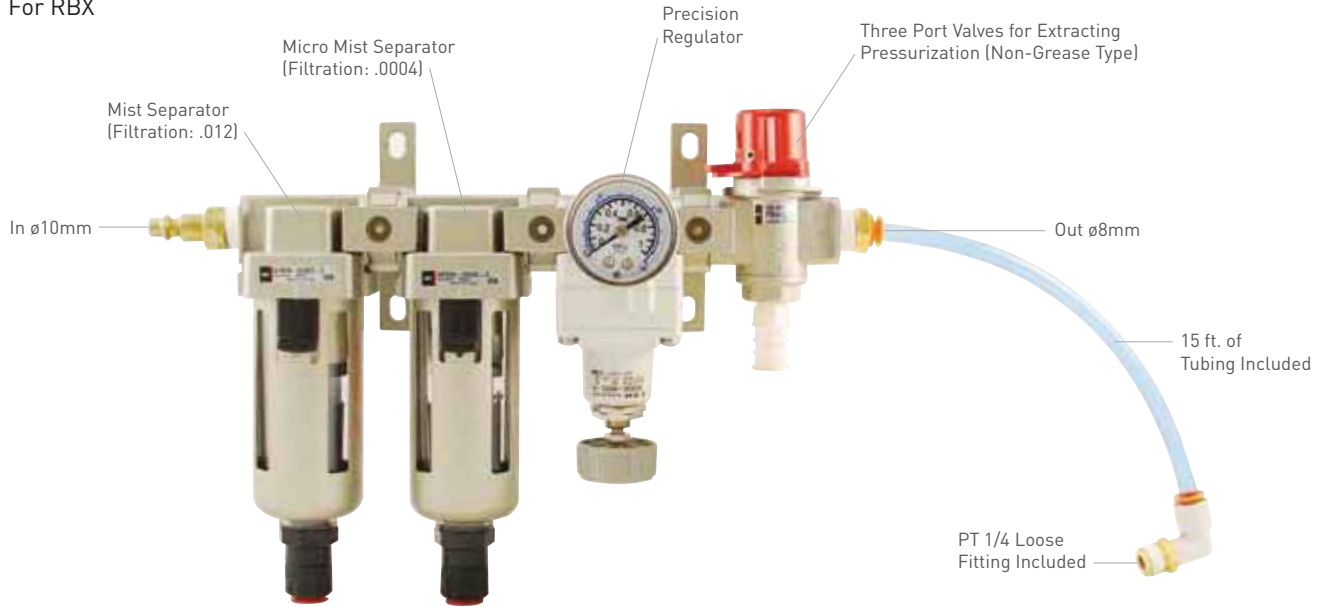

Catalog Number
XF1-NPT

TOOL HOLDER ACCESSORIES A.8

RBX12

For AIR POWER SPINDLE.

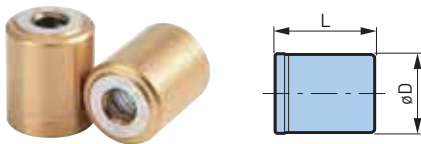

Catalog Number	øD	L	Body Type
MGN4S-HG	.47 (12mm)	.57 (14.5mm)	RBX12

ADJUSTING SCREW

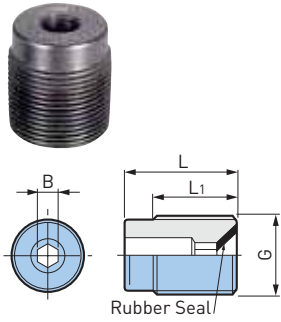

Catalog Number	G	L	L1	B	Body Model
NBA6B	M7	.47 (12mm)	.39 (10mm)	.08 (2mm)	MEGA6S/MEGA6N/MEGA6E/NBS6
NBA8B	M9	.51 (13mm)		.10 (2.5mm)	MEGA8S/MEGA8N/MEGA8E/NBS8
NBA10B	M11	.63 (16mm)	.47 (12mm)	.12 (3mm)	MEGA10N/MEGAER16/MEGA10E/NBS10
NBA13B	M14	.79 (20mm)	.59 (15mm)	.16 (4mm)	MEGA13N/MEGAER20/MEGA13E/NBS13
NBA16B	M18				MEGA16N/MEGAER25/NBS16
NBA20B	M21				MEGA20N/MEGAER32/NBS20
NBA25B	M27				MEGA25N

TAP DRIVING BACK STOP

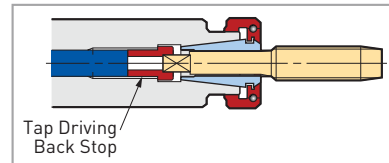
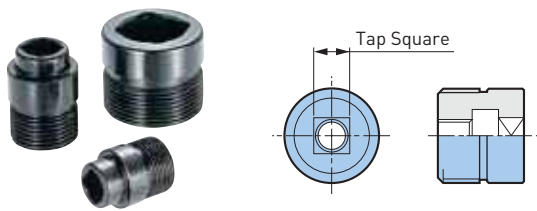

The Square of the Tap is Positively Located by Fitting the Tap Driving Back Stop

Tap Size	Standard	Tap Square	Catalog Number			
			NBS10	NBS13	NBS16	NBS20
M8	DIN 371	6.2mm	—	NBA13-M8DD	—	—
	JIS	5.0mm	NBA10-M8	NBA13-M8	—	—
M10	DIN 371	8.0mm	—	NBA13-M14M10DD	NBA16-M14M10DD	—
	JIS	5.5mm	NBA10-M10	NBA13-M10	NBA16-M10	—
M12	DIN 376	7.0mm	—	NBA13-M12D	NBA16-M12D	NBA20-M12D
	JIS	6.5mm	—	NBA13-M12	NBA16-M12	NBA20-M12
M14	DIN 376	9.0mm	—	—	NBA16-M14DM16D	NBA20-M14DM16D
	JIS	8.0mm	—	NBA13-M14M10DD	NBA16-M14M10DD	NBA20-M14
M16	DIN 376	9.0mm	—	—	NBA16-M14DM16D	NBA20-M14DM16D
	JIS	10.0mm	—	—	NBA16-M16	NBA20-M16
M18	DIN 376	11.0mm	—	—	—	NBA20-M18 ❖
	JIS	11.0mm	—	—	—	
M20	DIN 376	12.0mm	—	—	—	NBA20-M20 ❖
	JIS	12.0mm	—	—	—	

- Rigid tapping function is required on the machine tool
- Only exact size collet can be used with models marked ❖

SET SCREW



Catalog Number	Holder	Thread Size
11.690.517	EM.250	1/4"-28
11.690.518	EM.375	3/8"-24
11.690.519	EM.500	7/16"-20
11.690.520	EM.625	9/16"-18
11.690.521	EM.750	5/8"-18

Catalog Number	Holder	Thread Size
11.690.522	EM1.000	3/4"-16
11.690.522	EM1.250	3/4"-16
11.690.522	EM1.500	3/4"-16
11.690.524	EM2.000	1"-14

ADJUSTING SCREW

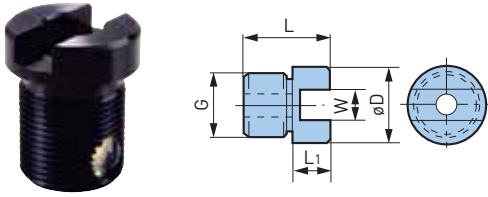

Catalog Number	øD	L	L1	G	W	MEGA DS	HMC
HMA-M16	.75	1.06	.24	M16 P1.5	.31	MEGA.750DS	HMC.750S
						MEGA1.000DS	HMC1.000S
						MEGA20D(DS)	HMC20(S)
						MEGA25D(DS)	HMC25(S)
HMA-M16S	.75	1.06	.24	M16 P1.5	.39	MEGA1.250DS (BCV40)	HMC32S
						MEGA32D(DS) (BBT30/40)	
HMA-M24	1.185	1.42	.37	M24 P1.5	.39	MEGA1.250DS	HMC32
						MEGA1.500DS	
						MEGA32D(DS)	HMC42(S)
						MEGA42D(DS)	
						MEGA50D(DS)	

CLAMP BOLT

Catalog Number	Catalog Number (Coolant Hole)	øD	L	L1	G
MBA-M12	TMBA-M12	33	10	2	12
-M12H	—			—	
-M16	-M16	40	10	6	16
-M16H	—			—	
-M20	-M20	50	14	6	20
-M20H	—			—	
-M24	-M24	65	10	10	24

LOCK SCREW



Catalog Number	Adapter	Thread Size
11.690.710	SMC.750	3/8"-24
11.690.711	SMC1.000	1/2"-20
11.690.712	SMC1.250	5/8"-18
11.690.713	SMC1.500	3/4"-16
11.690.714	SMC2.000	1"-14
11.690.715	SMC2.500	1"-14

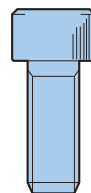

Catalog Number	Adapter	Thread Size
11.690.704	FMH16	M8-1.25
11.690.705	FMH22	M10-1.5
11.690.706	FMH27	M12-1.75
11.690.707	FMH32	M16-2
11.690.708	FMH40	M20-2.5

CK LOCKING SCREWS

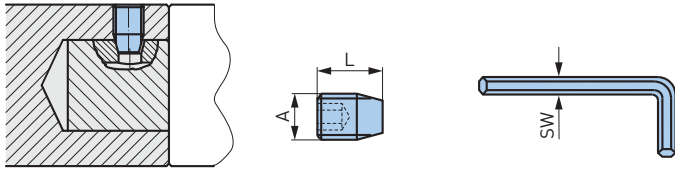

Catalog Number	Adapter Size	Wrench	SW (Hex Size)	Torque ft.-lbs.	A	L
10.690.431	CK1	10.690.811	2	1.8	M4xP0.5	.197
10.690.432	CK2	10.690.812	2.5	2.2	M5xP0.5	.250
10.690.433	CK3	10.690.813	3	3.8	M6xP0.75	.335
10.690.434	CK4	10.690.814	4	7.1	M8xP0.75	.433
10.690.435	CK5	10.690.816	5	15	M10xP1.0	.551
10.690.436	CK6	10.690.817	6	29	M12xP1.0	.709
10.690.437	CK7	10.690.808	10	73	M20xP1.5	1.142

DRIVE PIN

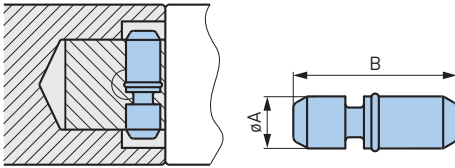

Catalog Number	CK	øA	L
10.691.501	CK1	.157	.531
10.691.502	CK2	.197	.669
10.691.503	CK3	.276	.866
10.691.504	CK4	.335	1.043
10.691.505	CK5	.433	1.300
10.691.506	CK6	.551	1.693
10.691.507	CK7	.709	2.205

ROUGH BORING

B.1

ROUGH BORING **B.1**



ROUGH BORING HEADS**394-411**

ROUGH BORING HEADS OVERVIEW	394
MW ROUGH BORING HEAD	395
SERIES 319 SW	396-398
SMART DAMPER BORING SW	399
SERIES 319 SW INSERT HOLDERS	400-402
FACE GROOVING HOLDERS FOR SW	403
TWN ROUGH BORING HEADS	404-405
OD TURNING WITH SW	406
CKB HEAVY METAL BARS	407
INSERT SELECTION & CUTTING DATA	408-409
GUIDELINES & TROUBLESHOOTING	410-411

MW



Small and powerful rough boring head: The MW comes with cylindrical shank and permits extremely fast roughing of small holes.

ø.630"-.827"
ST20

PG. 394

SW



Super-versatile rough boring head for highest cutting performance: Thanks to its clever design, the SW can be used for stepped and balanced roughing by simply switching the insert holders. Various accessories are available for chamfering, back boring and face grooving.

ø.797"-8.000"
CKB1-CKB7

PG. 396

SW-AL



The fastest solution for deep roughing: SW-AL, built of high quality aluminum, fits perfectly on CKN components. Long tool combinations are therefore up to 50% lighter than similar tools built of steel which enhances the productivity drastically.

ø2.677"-8.000"
CKN6-CKN7

PG. 398

SW SMART DAMPER



The solution for vibration-free rough boring. Its built-in patented Smart Damper technology is located close to the cutting edge and lifts the performance of rough boring on a new level.

ø1.614"-4.331"
CKB4-CKB6

PG. 399

TWN



The TWN rough boring heads have been developed for economical rough boring.

ø.787"-6.024"
CKB1-CKB7

PG. 406

MW ROUGH BORING HEAD

RANGE: ϕ .630"-.827"

The MW rough boring head permits extremely fast roughing of small holes.

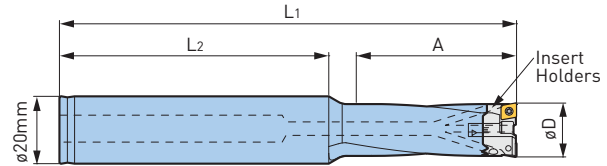
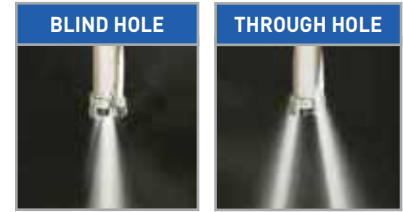

Body	ϕD	Insert Holders	L1	Effective Boring Length A	L2
ST20-MW1619-45	.630-.748	MW1619E	5.354	1.772	3.150
-60			5.945	2.362	
-MW1821-50	.709-.827	MW1821E	5.551	1.969	
-65			6.142	2.559	

- Clamping screw and wrench are included
- Inserts are not included and need to be ordered separately

INDEXABLE INSERTS

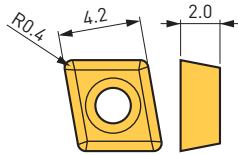

Material	Insert	Explanation of Grade
Steel, Stainless Steel	MW0404F(Z30P)	Substrate similar to P30 TiAlN+AlCrN coating
Cast Iron, Ductile Iron	MW0404S(Z30K)	Substrate similar to K20 TiAlN+AlCrN coating
Nonferrous, Aluminum	MW0404E(D15N)	Substrate similar to K15 DLC coating

- Inserts are sold in packages of 10 pieces
- Order example: MW0404F Z30P----10 pieces in a package

INSERT CLAMPING SCREW SET



Set Model	Screw Caps	Wrench
S1.6S-T6	M1.6x4.2	FA-T6

- 10 screws and 1 wrench are included in a set

SERIES 319 SW APPLICATION EXAMPLES

ROUGH BORING BALANCE

Insert Holders: Type CC/SP/SC
 ø20-203 mm
 High feed rates

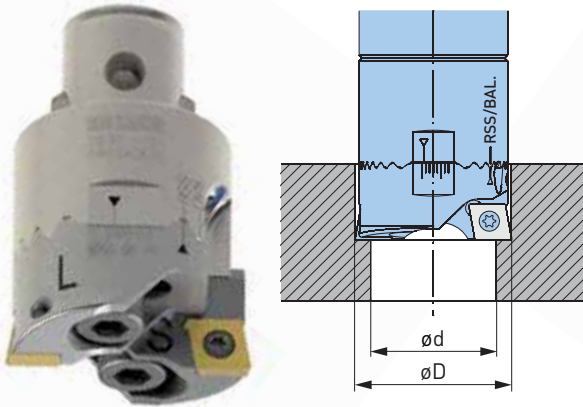

ROUGH BORING STEP

Insert Holders: Type CC
 ø20-203 mm
 Double stock removal, half the feed rate

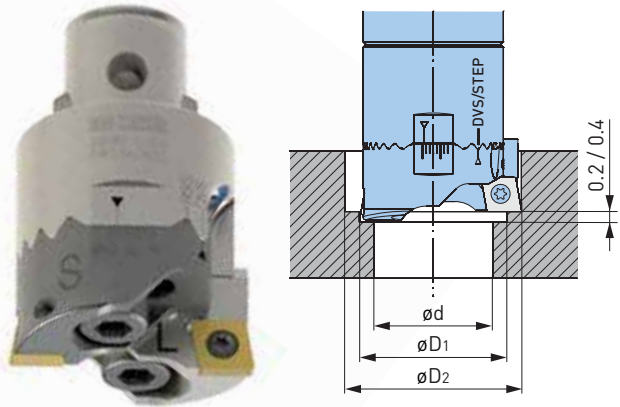
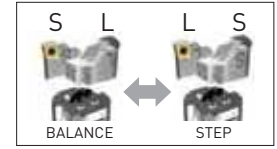

CHAMFERING

ø30-10mm
 Adjustable chamfer angle 15°-75°

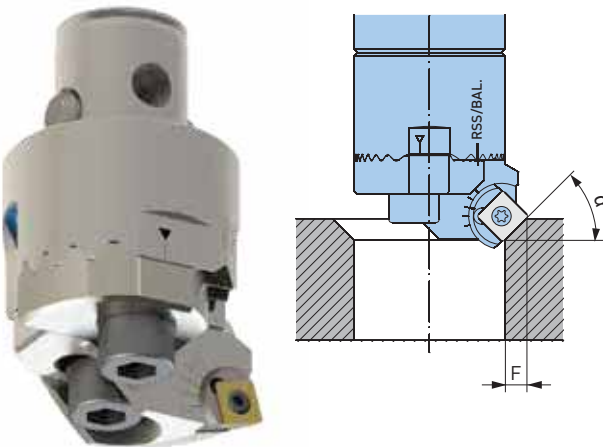

BACK BORING

ø44-211mm
 Lead angle 90°

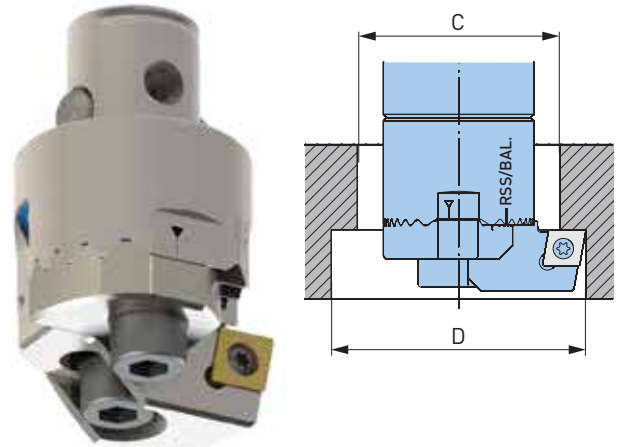

SERIES 319 SW

RANGE: ϕ .787"-8.000"

US PATENT #
8,747,034

The short and compact design of the components combined with a positive and friction locked connection between the tool body and insert holders provide maximum rigidity and highest cutting performance.

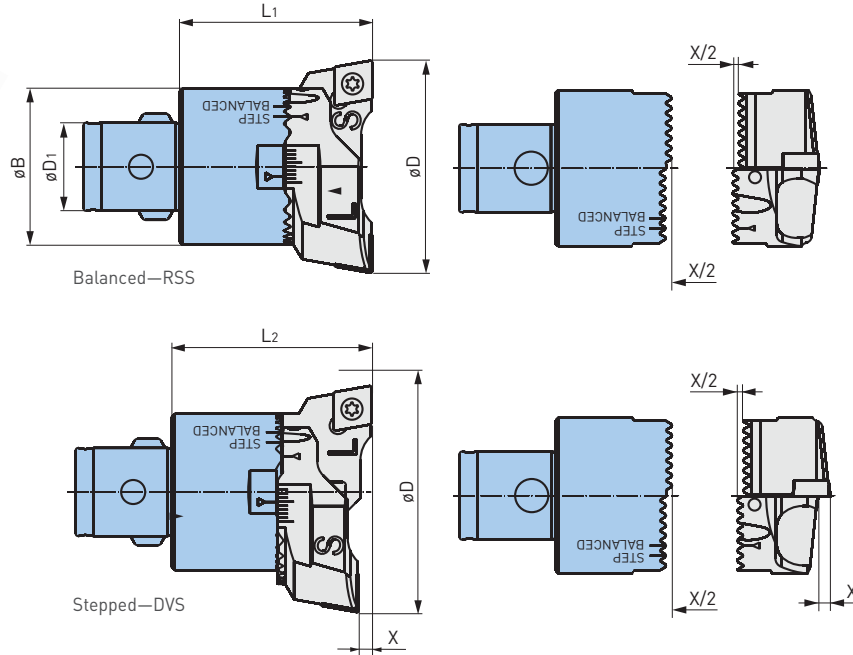

Catalog Number	Reference Number	CK	ϕ D	ϕ D1	L1	L2	X (Step)	Weight (lbs.)
SW20-31CKB1	10.319.101	CKB1	.787-1.220	.748	1.280	1.284	.008	.1
SW25-40CKB2	10.319.201	CKB2	.984-1.575	.945	1.398	1.402	.008	.2
SW32-51CKB3	10.319.301	CKB3	1.260-2.008	1.220	1.575	1.579	.008	.4
SW41-66CKB4	10.319.401	CKB4	1.614-2.598	1.535	1.850	1.858	.016	.8
SW53-86CKB5	10.319.501	CKB5	2.087-3.386	1.969	2.244	2.252	.016	1.5
SW68-110CKB6	10.319.601	CKB6	2.677-4.331	2.500	2.795	2.803	.016	2.6
SW98-153CKB6	10.319.602		3.858-6.024	3.543				4.2
SW148-203CKB6	10.319.603		5.827-8.000	5.512				5.0
SW98-153CKB7-87	10.319.701	CKB7	3.858-6.024	3.543	3.425	3.433	.016	6.3
-153CKB7-117	10.319.702		3.858-6.024		4.606	4.614	.016	9.1
SW148-203CKB7	10.319.703		5.827-8.000	5.512				11.3

ACCESSORIES

 <p>SPARE PARTS PG. 399</p>	 <p>INSERTS PG. 506</p>	 <p>APPLICATION ADVICE PG. 408</p>
--	--	---

SERIES 319 SW ALUMINUM

RANGE: $\phi 2.677''$ - $8.000''$

Tool body made of high strength aluminium with CKN connection.

AVAILABLE IN ALUMINUM

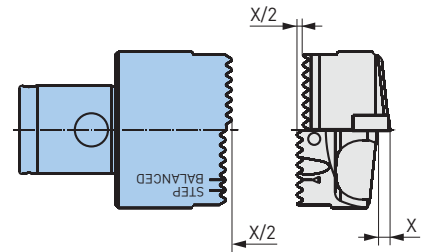
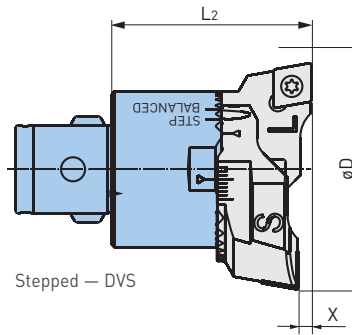
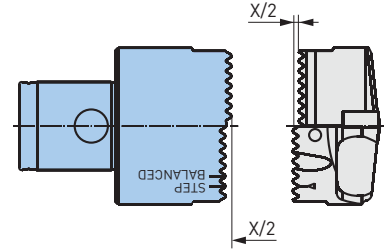
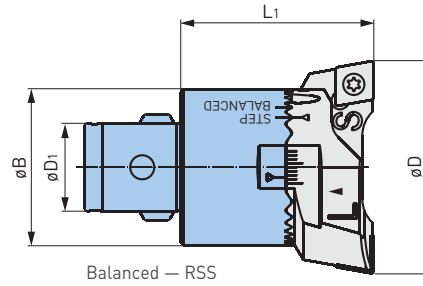

Catalog Number	Reference Number	CK	ϕD	ϕD_1	L_1	L_2	X (Step)	Weight (lbs.)
SW68-110CKN6AL	10.319.604N	CKN6	2.677-4.331	2.500	2.795	2.803	.016	1.1
SW98-153CKN6AL	10.319.605N		3.858-6.024	3.543				2.0
SW148-203CKN6AL	10.319.607N		5.827-8.000	5.512				2.4
SW98-153CKN7-87AL	10.319.705N	CKN7	3.858-6.024	3.543	3.425	3.433	.016	2.9
-153CKN7-117AL	10.319.706N		3.858-6.024		3.4			
SW148-203CKN7AL	10.319.707N		5.827-8.000	5.512	4.606	4.614		4.6

SMART DAMPER BORING SW

The Well Established Dynamic Damper Eliminates Chatter in Heavy Work Loads

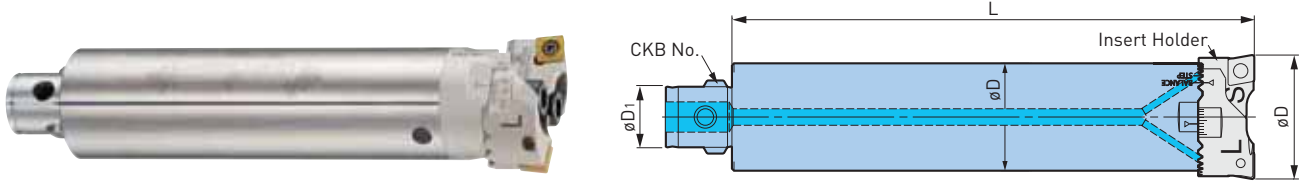

Catalog Number	CK	øD	øD1	L	Weight (lbs.)
CKB4-SW41DP-190	CKB4	1.614-2.598	1.535	7.480	5.3
CKB5-SW53DP-220	CKB5	2.087-3.386	1.969	8.661	9.9
CKB6-SW68DP-245	CKB6	2.677-4.331	2.520	9.646	18.3

- Clamp bolts and bellville springs are included, cartridge and insert must be ordered separately
- Designed to be capable of supplying coolant through body

SPARE PARTS

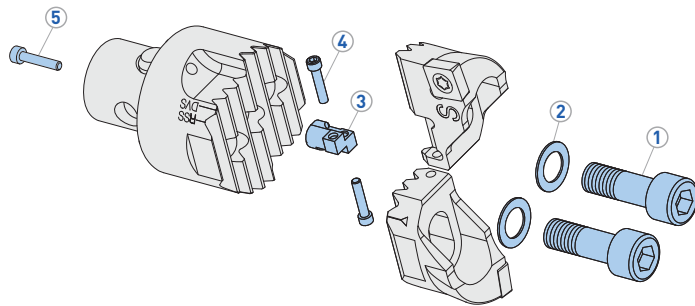

Head Type	Clamping Screw (1)	Washer (2)	Torque (ft-lbs.)	Clamping Screw Wrench	Coolant Port	Adjusting Housing (3)	Adjusting Screw (4)	Adjusting Screw Wrench	Housing Screw (5)
SW20	10.690.188	10.693.175	3	10.690.803	—	10.319.150	10.690.191	10.690.819	10.690.184
SW25	10.690.157	10.693.176	5	10.690.804	—	10.319.250	10.690.192	10.690.819	10.690.186
SW32	10.690.108	10.693.177	9	10.690.805	—	10.319.350	10.690.193	10.690.811	10.690.189
SW41	10.690.163	10.693.178	18	10.690.806	—	10.319.450	10.690.194	10.690.812	10.690.189
SW53	10.690.105	10.693.179	44	10.690.807	10.692.409	10.319.550	10.690.195	10.690.812	10.690.189
SW68	10.690.106	10.693.179	44	10.690.807	10.692.406	10.319.650	10.690.196	10.690.813	10.690.101
SW98/148	10.690.970	10.693.187	59	10.690.810	10.692.406	10.319.750	10.690.197	10.690.814	10.690.108*

*For KAB7/CKN7 heads, use **10.690.173**

SERIES 319 SW INSERT HOLDERS

CC (SOLD IN PAIRS)

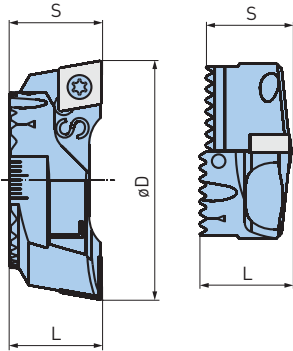

Head Type	Catalog Number	Reference Number	øD	Insert
SW20	IH1SW20C	10.639.413	.787-1.024	CC..06
	IH2SW20C	10.639.417	.984-1.220	
SW25	IH1SW25C	10.639.423	.984-1.299	CC..06
	IH2SW25C	10.639.427	1.260-1.575	
SW32	IH1SW32C	10.639.433	1.260-1.654	CC..09
	IH2SW32C	10.639.437	1.614-2.008	
SW41	IH1SW41C	10.639.443	1.614-2.126	CC..09
	IH2SW41C	10.639.447	2.087-2.598	
SW53	IH1SW53C	10.639.453	2.087-2.756	CC..12
	IH2SW53C	10.639.457	2.717-3.386	
SW68	IH1SW68C	10.639.463	2.677-3.543	CC..12
	IH2SW68C	10.639.467	3.465-4.331	
SW98	IH1SW98C	10.639.473	3.858-4.961	CC..12
	IH2SW98C	10.639.477	4.921-6.024	
SW148	IH1SW148C	10.639.483	5.827-6.929	CC..12
	IH2SW148C	10.639.487	6.890-8.000	

ADDITIONAL INSERT HOLDERS — CC..16

SW68	IH1SW68C	10.639.563	2.677-3.543	CC..16
	IH2SW68C	10.639.567	3.465-4.331	
SW98	IH1SW98C	10.639.573	3.858-4.961	CC..16
	IH2SW98C	10.639.577	4.921-6.024	
SW148	IH1SW148C	10.639.583	5.827-6.929	CC..16
	IH2SW148C	10.639.587	6.890-8.000	

SP & SC (SOLD IN PAIRS)

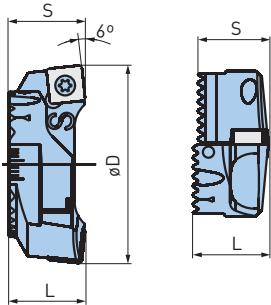

Head Type	Catalog Number	Reference Number	øD	Insert
SW20	IH1SW20S	10.639.113	.787-1.024	SP..06
SW25	IH1SW25S	10.639.123	.984-1.299	SP..06
SW32	IH1SW32S	10.639.133	1.260-1.654	SC..09
	IH2SW32S	10.639.137	1.614-2.008	
SW41	IH1SW41S	10.639.143	1.614-2.126	SC..09
	IH2SW41S	10.639.147	2.087-2.598	
SW53	IH1SW53S	10.639.153	2.087-2.756	SC..12
	IH2SW53S	10.639.157	2.717-3.386	
SW68	IH1SW68S	10.639.163	2.677-3.543	SC..12
	IH2SW68S	10.639.167	3.465-4.331	
SW98	IH1SW98S	10.639.173	3.858-4.961	SC..12
	IH2SW98S	10.639.177	4.921-6.024	
SW148	IH1SW148S	10.639.183	5.827-6.929	SC..12
	IH2SW148S	10.639.187	6.890-8.000	

SERIES 319 SW CHAMFERING INSERT HOLDERS

These insert holders are made for front and back chamfering on the twin cutter roughing heads Series 319 SW41-SW148 and cover the diameter range $\phi 1.299''$ - $8.268''$. The desired chamfering angle is adjustable from 15° - 75° . The set contains one insert holder and one blank piece.

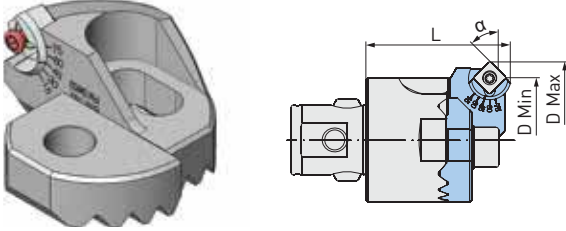

Boring Head	Catalog Number	Reference Number	Insert	15°	30°	45°	60°	75°
SW41	IH1SW41CF	10.639.104	SC..09	1.850-2.362	1.929-2.441	1.968-2.480	1.968-2.480	1.929-2.441
SW53	IH1SW53CF	10.639.105		2.323-2.992	2.402-3.071	2.441-3.110	2.441-3.110	2.402-3.071
SW68	IH1SW68CF	10.639.106		2.953-3.819	3.032-3.898	3.071-3.937	3.071-3.937	3.032-3.898
SW98	IH1SW98CF	10.639.107	SC..12	3.858-4.961	3.936-5.039	3.976-5.079	3.936-5.039	3.897-5.000
	IH2SW98CF	10.639.108		4.921-6.024	4.999-6.102	5.039-6.142	4.999-6.102	4.960-6.063
SW148	IH1SW148CF	10.639.109		5.984-7.087	6.062-7.165	6.102-7.205	6.062-7.165	6.023-7.126
	IH2SW148CF	10.639.110		7.047-8.150	7.125-8.228	7.165-8.268	7.125-8.228	7.086-8.189

*Insert holder must be mounted on RSS/BALANCED side of boring head

RADIAL CHAMFER LENGTH FOR FRONT (F1) AND BACK (F2) CHAMFERING

Applicable for inserts with .016" nose radius.

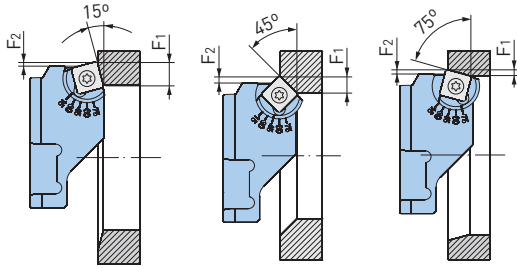

Head Type	Insert	15°		30°		45°		60°		75°	
		F1	F2	F1	F2	F1	F2	F1	F2	F1	F2
SW41	SC..09	.303	.028	.272	.055	.224	.071	.157	.067	.083	.047
SW53											
SW68											
SW98	SC..12	.417	.047	.374	.087	.307	.102	.217	.098	.110	.071
SW148											

SPARE PARTS

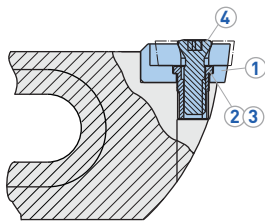

Head Type	1 Pocket	2 Screw	3 Wrench	Insert	4 Pin	Torque (ft.-lbs.)
SW41	10.695.101	10.691.756	10.690.899	SC..09	10.694.138	2.2
SW53	10.695.101	10.691.756	10.690.899		10.694.138	
SW68	10.695.101	10.691.755	10.690.899		10.694.138	
SW98	10.695.102	10.691.757	10.690.804	SC..12	10.694.145	2.2
	10.695.102	10.691.757	10.690.804		10.694.145	
SW148	10.695.102	10.691.757	10.690.804		10.694.145	
	10.695.102	10.691.757	10.690.804		10.694.145	

SERIES 319 SW BACK BORING INSERT HOLDERS

These insert holders are made for back boring with the twin cutter rough boring heads Series 319 SW32-SW148 and cover the diameter range from $\phi 1.732''$ - $8.307''$. The set contains one insert holder and one blank piece.

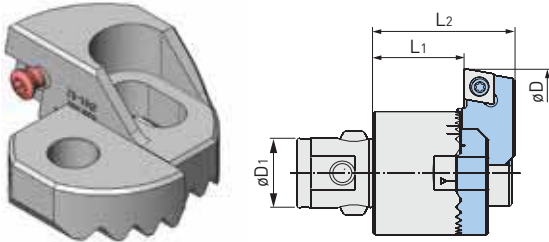

Boring Head	Catalog Number	Reference Number	Insert	ϕD	$\phi D1$	L1*	L2*
SW32	IH1SW32BB	10.639.403	CC..09	1.732-2.126	1.220	.945	1.496
SW41	IH1SW41BB	10.639.404		2.087-2.598	1.535	1.142	1.732
SW53	IH1SW53BB	10.639.405		2.559-3.228	1.969	1.339	2.165
SW68	IH1SW68BB	10.639.406		3.189-4.055	2.500	1.614	2.598
SW98 (CKB6/CKN6)	IH1SW98BB	10.639.407		4.016-5.118	3.543	1.496	2.717
	IH2SW98BB	10.639.408	5.079-6.181				
SW148 (CKB6/CKN6)	IH1SW148BB	10.639.409	CC..12	6.142-7.244	5.512	1.850/3.031	3.071/4.252
	IH2SW148BB	10.639.410		7.205-8.307			
SW98 (CKB7/CKN7)	IH1SW98BB	10.639.407		4.016-5.118	3.543		
	IH2SW98BB	10.639.408		5.079-6.181			
SW148 (CKB7/CKN7)	IH1SW148BB	10.639.409	6.142-7.244	5.512	3.031	4.252	
	IH2SW148BB	10.639.410	7.205-8.307				

*With SW98L x KAB7/CKN7

ROUGH BORING B.1

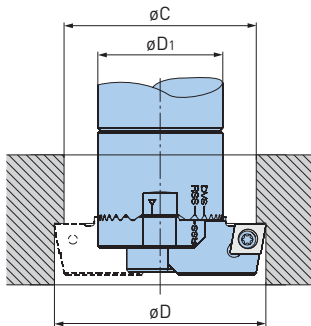

Back Bore & Entry Bore Diameters

Maximum Back Bore Diameter "D"	$D \text{ Max} = [2xC] - D1$
Maximum Body Diameter "D1"	$D1 \text{ Max} = [2xC] - D$
Minimum Entry Bore Diameter "C"	$C \text{ Min} = [D + D1] / 2$

FACE GROOVING HOLDERS FOR SW

Upgrade your existing rough boring heads SW: the face grooving holder provide the possibility to manufacture grooves in the diameter range from $\phi 2.087'' - 7.992''$.

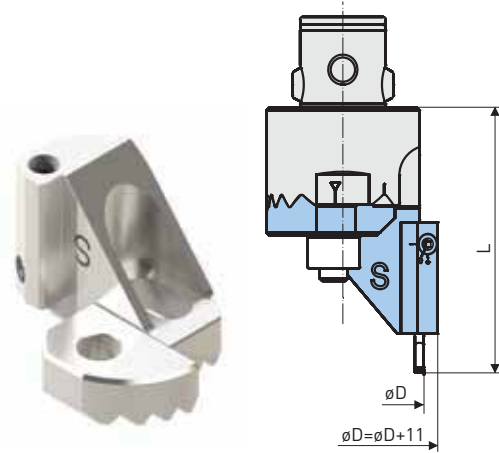
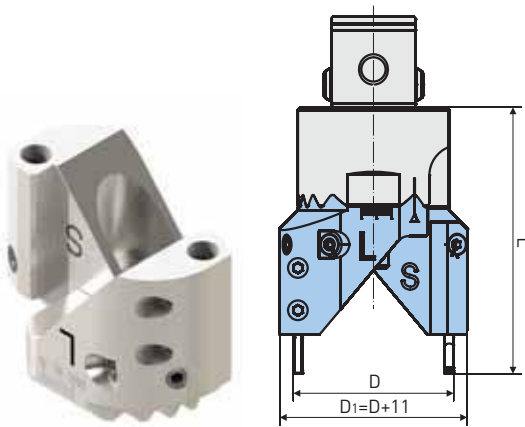

TWIN CUTTER SET

Head Type	Catalog Number	Reference Number	ϕD	L
SW53	IH1SW53FG	10.639.653	2.087-2.756	3.465
SW68	IH1SW68FG	10.639.663	2.677-3.543	3.740
	IH2SW68FG	10.639.667	3.465-4.331	
SW98	IH1SW98FG	10.639.673	3.858-4.961	4.449
	IH2SW98FG	10.639.677	4.921-6.024	
SW148	IH1SW148FG	10.639.683	5.827-6.929	5.630
	IH2SW148FG	10.639.687	6.890-8.000	

SINGLE CUTTER SET

Head Type	Catalog Number	Reference Number	ϕD	L
SW53	IH1SW53FG-S	10.639.654	2.087-2.756	3.465
SW68	IH1SW68FG-S	10.639.664	2.677-3.543	3.740
	IH2SW68FG-S	10.639.668	3.465-4.331	
SW98	IH1SW98FG-S	10.639.674	3.858-4.961	4.449
	IH2SW98FG-S	10.639.678	4.921-6.024	
SW148	IH1SW148FG-S	10.639.684	5.827-6.929	5.630
	IH2SW148FG-S	10.639.688	6.890-8.000	

CUTTERS

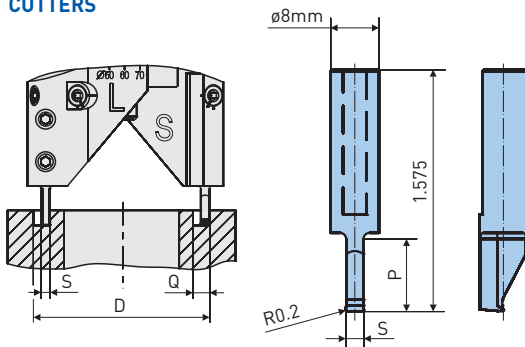

Catalog Number	Reference Number	S	Q Max	Insert Grade	P Max
FG2-ST8-40K40	10.958.601	2mm	.138	Uncoated K40	.472
FG3-ST8-40K40	10.958.602	3mm	.217		
FG4-ST8-40K40	10.958.603	4mm	.295		
FG5-ST8-40K40	10.958.604	5mm	.375		
FG2-ST8-40K40C	10.958.611	2mm	.138	Coated P40C	
FG3-ST8-40K40C	10.958.612	3mm	.217		
FG4-ST8-40K40C	10.958.613	4mm	.295		
FG5-ST8-40K40C	10.958.614	5mm	.375		

TWN ROUGH BORING HEADS

RANGE: ϕ .787"-6.024"

The heads of the TWN series have been developed for economical heavy duty rough boring.

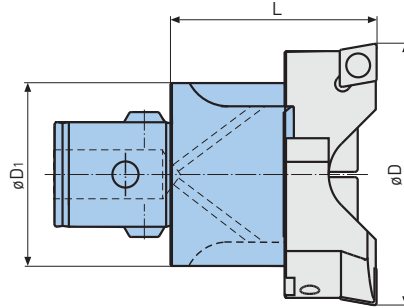

Catalog Number	Reference Number	CK	ϕ D	ϕ D1	L	Weight (lbs.)
TWN20-31CKB1	10.315.101	CKB1	.787-1.220	.728	1.280	.1
TWN25-40CKB2	10.315.201	CKB2	.984-1.575	.921	1.398	.2
TWN32-51CKB3	10.315.301	CKB3	1.260-2.008	1.181	1.575	.4
TWN41-66CKB4	10.315.401	CKB4	1.614-2.598	1.535	1.850	.8
TWN53-86CKB5	10.315.501	CKB5	2.087-3.386	1.929	2.244	1.4
TWN68-110CKB6	10.315.601	CKB6	2.677-4.331	2.480	2.795	2.9
TWN98-153CKB6	10.315.602	CKB6	3.858-6.024	3.543	2.795	4.1
-153-CKB7	10.315.701	CKB7	3.858-6.024		3.425	6.8

ACCESSORIES



INSERT HOLDERS—TYPE CC (SOLD IN PAIRS)

Standard insert holders for CC- type inserts with 90° lead angle. For through- and blind holes. Symmetrical and double offset cutting edge arrangement possible.

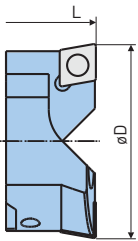

Head Type	Catalog Number	Reference Number	ϕ D	Insert
TW20	IH1TW20C	10.638.411	.787-1.024	CC..06
	IH2TW20C	10.638.412	.984-1.220	
TW25	IH1TW25C	10.638.421	.984-1.300	CC..09
	IH2TW25C	10.638.422	1.260-1.575	
TW32	IH1TW32C	10.638.431	1.260-1.654	CC..12
	IH2TW32C	10.638.432	1.614-2.008	
TW41	IH1TW41C	10.638.441	1.614-2.126	CC..12
	IH2TW41C	10.638.442	2.087-2.598	
TW53	IH1TW53C	10.638.451	2.087-2.756	CC..12
	IH2TW53C	10.638.452	2.717-3.386	
TW68	IH1TW68C	10.638.461	2.677-3.543	CC..12
	IH2TW68C	10.638.462	3.465-4.331	
TW98	IH1TW98C	10.638.471	3.858-4.961	CC..12
	IH2TW98C	10.638.472	4.921-6.024	

ACCESSORIES



SPARE PARTS — SERIES 315 TWN

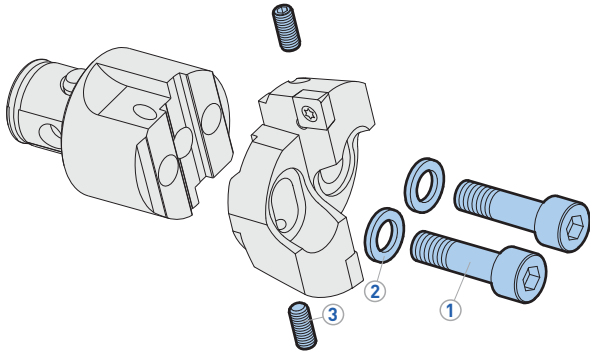

Head Type	Clamping Screw (1)		Clamping Screw Wrench	Washer (2)	Adjusting Screw (3)	
	Catalog Number	Torque (ft-lbs)			Catalog Number	Torque (in-lbs)
TW20	10.315.160	3	10.690.803	10.693.180	10.690.529	1.5
TW25	10.315.250	5	10.690.804	10.693.181	10.690.538	1.8
TW32	10.315.350	9	10.690.805	10.693.182	10.690.426	3
TW41	10.315.450	22	10.690.806	10.693.183	10.690.537	7
TW53	10.315.550	44	10.690.807	10.693.184	10.690.586	13
TW68	10.315.650	44	10.690.807	10.693.184	10.690.584/587	18
TW98	10.315.750	59	10.690.810	10.693.185	10.690.585/588	18
TW148	10.315.750	59	10.690.810	10.693.185	10.690.585/588	18

OD TURNING WITH SW

RANGE: $\varnothing 16$ -120mm

This program consists of tool holders with CKB5 and CKB6 connectors, made for different turning ranges and with tool connections in the sizes CKB3, CKB4 and CKB5. The corresponding precision finish or rough boring heads and counterweights can be mounted on the tool holder either directly or by means of an extension. With this program, outer diameters in the range from $\varnothing 16$ -120mm can be machined.

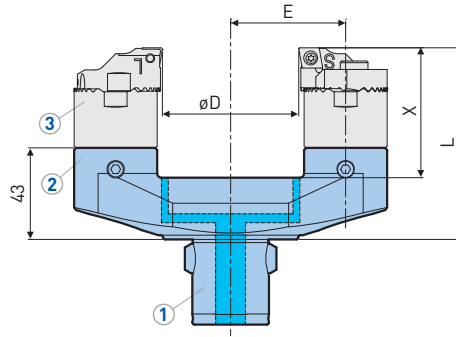

Catalog Number	Reference Number	CK (1)	CK (2)	$\varnothing D1$	E	L*	X*	Weight (lbs.)
OD16-44CKB5-CKB3	10.335.906	CKB5	CKB3	4.213	1.496	3.268 [4.449] [5.039]	2.008 [3.189] [3.780]	5.9
-44CKB6-CKB3	10.335.905	CKB6	CKB3	4.213	1.496	3.268 [4.449] [5.039]	2.008 [3.189] [3.780]	3.2
OD34-67CKB6-CKB4	10.335.904	CKB6	CKB4	5.787	2.126	3.543 [5.118] [5.906]	2.283 [3.858] [4.646]	3.9
OD57-90CKB6-CKB4	10.335.903	CKB6	CKB4	6.693	2.579	3.543 [5.118] [5.906]	2.283 [3.858] [4.646]	4.6
OD78-120CKB6-CKB5	10.335.902	CKB6	CKB5	8.740	3.406	3.937 [6.299] [7.480]	2.677 [5.039] [6.220]	6.1

*The numbers in brackets indicate the tool length (L) and the max. pin length (X) with the use of the corresponding extensions.

ACCESSORIES



CAUTION

Counter-clockwise rotation of spindle!
Vc max 1,500 SFM

INSERT HOLDERS—ROUGH BORING

Turning Adapter		Boring Head (x2)		Insert Holders (1 pair)		Turning Range
Catalog Number	Reference Number	Catalog Number	Reference Number	Catalog Number	Reference Number	
OD16-44CKB5-CKB3	10.335.906	SW32-51CKB3	10.319.301	IH2SW32C	10.639.437	.984-1.378
				IH1SW32C	10.639.433	1.339-1.732
OD16-44CKB6-CKB3	10.335.905	SW32-51CKB3	10.319.301	IH2SW32C	10.639.437	.984-1.378
				IH1SW32C	10.639.433	1.339-1.732
OD34-67CKB6-CKB4	10.335.904	SW41-66CKB4	10.319.401	IH2SW41C	10.639.447	1.654-2.165
				IH1SW41C	10.639.443	2.126-2.638
OD57-90CKB6-CKB4	10.335.903	SW41-66CKB4	10.319.401	IH2SW41C	10.639.447	2.559-3.071
				IH1SW41C	10.639.443	3.031-3.543
OD78-120CKB6-CKB5	10.335.902	SW53-86CKB5	10.319.501	IH2SW53C	10.639.457	3.425-4.094
				IH1SW53C	10.639.453	4.055-4.724

CKB HEAVY METAL BARS

For Roughing

Tool combinations with heavy metal boring bars give higher rigidity and damping of vibration over conventional steel shank tools when roughing long bores over 5:1. Their dense structure and machinability gives higher toughness over carbide.

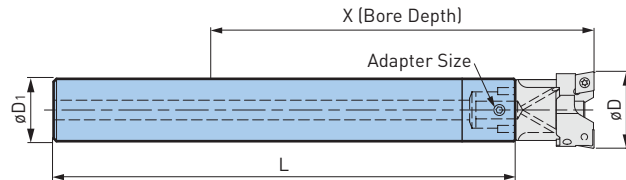

Catalog Number	Reference Number	Size	ϕD_1	L	X	ϕD		Weight (lbs.)
						Min	Max	
ST.750-CKB1-190TM	11.370.321	CKB1	.750	7.480	6.889	.787	1.220	1.6
-240TM	11.370.322			9.450	8.559	.787	1.220	2.1
ST24-CKB2-218TM	11.370.324	CKB2	24mm	8.580	7.793	.984	1.575	2.4
-290TM	11.370.325			11.420	10.633	.984	1.575	4.0
ST1.250-CKB3-235TM	11.370.328	CKB3	1.250	9.250	8.266	1.260	2.008	5.8
-350TM	11.370.327			13.780	12.796	1.260	2.008	8.0
ST1.500-CKB4-254TM	11.370.330	CKB4	1.500	10.000	8.622	1.614	2.598	8.8
-375TM	11.370.101			14.750	13.372	1.614	2.598	13.3

ACCESSORIES

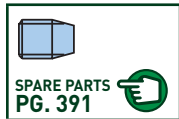

Use HMC Chucks for Optimal Holding



INSERT SELECTION & CUTTING DATA

Recommended Inserts & Cutting Data for Rough Boring Under Optimal Conditions

- Rigid fixturing and workpiece
- Good machine spindle with adequate hp and thrust
- Setup not chatter prone



Material	Nose Radius	CC..06 (1/4" I.C.)						CC..09 (3/8" I.C.)				CC..12 (1/2" I.C.)					
		Catalog Number	Balanced Cutting		Step Cutting		Catalog Number	Balanced Cutting		Step Cutting		Catalog Number	Balanced Cutting		Step Cutting		
			Feed (IPR)	Max ø D.O.C.	Feed (IPR)	Max ø D.O.C.		Feed (IPR)	Max ø D.O.C.	Feed (IPR)	Max ø D.O.C.		Feed (IPR)	Max ø D.O.C.	Feed (IPR)		Max ø D.O.C.
Mild Steels 10XX-15XX 1018, 1020, 1551	.016	11.654.850	.012	.200	.006	.300	11.654.940	.014	.300	.008	.500	11.654.993	.014	.350	.008	.600	
	.031	11.654.860	.014	.200	.007	.300	11.654.952	.018	.300	.010	.500	11.654.990	.020	.400	.012	.800	
High Carbon Alloy Steels 23XX-92XX 4130, 4340, 8620	.016	11.654.850	.010	.200	.005	.300	11.654.940	.012	.300	.006	.500	11.654.993	.012	.350	.008	.600	
	.031	11.654.860	.012	.200	.006	.300	11.654.952	.016	.300	.008	.500	11.654.990	.018	.400	.012	.800	
300 Series Stainless Steel 304, 316, 17-4ph	.016	11.654.853	.010	.170	.005	.250	11.654.943	.012	.250	.006	.450	—	—	—	—	—	
	.031	11.654.869	.012	.170	.006	.250	11.654.953	.016	.250	.008	.450	11.654.983	.018	.325	.010	.600	
400 Series Stainless Steel Martensitic	.016	11.654.850	.010	.200	.005	.300	11.654.940	.012	.300	.006	.500	11.654.993	.012	.350	.008	.600	
	.031	11.654.860	.012	.200	.006	.300	11.654.952	.016	.300	.008	.500	11.654.990	.018	.400	.012	.800	
Grey Cast Iron Class 30	.016	11.654.850	.012	.250	.006	.400	11.654.940	.014	.400	.008	.750	11.654.993	.014	.500	.008	.800	
	.031	11.654.850	.014	.250	.007	.400	11.654.952	.018	.400	.010	.750	11.654.990	.020	.600	.012	1.00	
Ductile/Nodular Cast Iron	.016	11.654.850	.010	.225	.005	.350	11.654.940	.012	.350	.006	.625	11.654.993	.012	.450	.008	.700	
	.031	11.654.860	.012	.225	.006	.350	11.654.952	.016	.350	.008	.625	11.654.990	.018	.500	.012	.900	
High Temp. Alloys Titanium, Inconel, Monel, etc.	.016	11.654.868	.008	.140	.004	.200	11.654.968	.010	.180	.005	.350	—	—	—	—	—	
	.031	—	—	—	—	—	11.654.969	.012	.200	.006	.400	11.654.978	.014	.280	.007	.500	
Brass and Bronze	.016	11.654.858	.012	.250	.006	.400	11.654.957	.014	.400	.008	.750	11.654.989	.014	.500	.008	.800	
	.031	11.654.864	.014	.250	.007	.400	11.654.958	.018	.400	.010	.750	11.654.991	.020	.600	.012	1.000	
Aluminum and Non-Ferrous	.016	10.654.888	.012	.300	.006	.500	10.654.977	.014	.500	.008	.900	10.654.995	.016	.550	.010	1.000	
	.031	11.654.898	.014	.300	.008	.500	10.654.987	.018	.500	.010	.900	10.654.992	.022	.650	.012	1.250	

CAUTION

Maximum cutting speed: 4,000 SFM. All cutting data without guarantee.

Cutting Speed:

$$RPM = \frac{SFM \times 3.82}{Bore \ \phi}$$

Feed Rate:

$$IPM = RPM \times IPR$$



Catalog Number	CC..16 [5/8" I.C.]					SP..08 [5/16" I.C.]			SC..09 [3/8" I.C.]			SC..12/SD..12 [1/2" I.C.]			Speed (SFM)
	Balanced Cutting		Step Cutting			Catalog Number	Balanced Cutting		Catalog Number	Balanced Cutting		Catalog Number	Balanced Cutting		
	Feed (IPR)	Max ø D.O.C.	Feed (IPR)	Max ø D.O.C.			Feed (IPR)	Max ø D.O.C.		Feed (IPR)	Max ø D.O.C.		Feed (IPR)	Max ø D.O.C.	
—	—	—	—	—	—	10.654.150	.014	.175	11.654.240	.016	.280	11.654.340	.016	.350	850-1200
11.654.996	.024	.600	.014	1.120		—	—	—	11.654.250	.020	.280	11.654.350	.022	.380	
—	—	—	—	—	—	10.654.150	.012	.175	11.654.240	.014	.280	11.654.340	.014	.350	700-1000
11.654.996	.022	.600	.012	1.120		—	—	—	11.654.250	.018	.280	11.654.350	.020	.380	
—	—	—	—	—	—	10.654.150	.012	.125	11.654.247	.014	.230	—	—	—	375-600
10.654.996	.022	.400	.012	.800		—	—	—	11.654.200	.018	.230	11.654.353	.020	.300	
—	—	—	—	—	—	10.654.150	.012	.175	11.654.240	.014	.280	11.654.340	.014	.350	500-750
10.654.996	.022	.600	.012	1.120		—	—	—	11.654.250	.018	.280	11.654.350	.020	.380	
—	—	—	—	—	—	10.654.152	.014	.200	11.654.240	.016	.380	11.654.340	.016	.480	450-750
11.654.996	.024	.750	.014	1.400		—	—	—	11.654.250	.020	.380	11.654.350	.022	.580	
—	—	—	—	—	—	10.654.152	.012	.175	11.654.240	.014	.330	11.654.340	.014	.420	300-425
11.654.996	.022	.675	.012	1.250		—	—	—	11.654.250	.018	.330	11.654.350	.020	.480	
—	—	—	—	—	—	10.654.152	—	—	11.654.249	.010	.160	—	.010	.200	100-225
10.654.997	.016	.380	.008	.700		—	—	—	11.654.259	.012	.180	11.654.359	.014	.250	
—	—	—	—	—	—	10.654.152	.014	.200	11.654.249	.016	.380	—	.016	.480	750-1000
10.654.997	.024	.750	.014	1.400		—	—	—	11.654.259	.020	.380	11.654.359	.022	.580	
—	—	—	—	—	—	10.654.168	.014	.200	10.654.277	.016	.500	—	—	—	1100-1600
10.654.998	.030	.900	.015	1.625		—	—	—	10.654.287	.020	.500	10.654.387	.022	.650	

ROUGH BORING GUIDELINES

Insert Selection & Stock Allowance

KAISER indexable inserts outlined in the Insert Selection & Cutting Data tables have been selected to give optimum results. Grades and geometry do not have to be specified at time of order.

Insert radius is based upon 2 major factors:

1. Length/Diameter ratio of tool
2. Depth of cut or material allowance
 - Select the largest nose radius available for cutting edge strength & higher feeds
 - Use small nose radius for light depth of cut & extreme L/D ratio

Insert Radius	Minimum D.O.C.	Maximum D.O.C.	L/D Ratio
.008 (0)	.010	.060	>6:1
.016 (1)	.020	.120	≤5:1
.031 (2)	.040	.200	≤4:1
.047 (3)	.060	.325	≤4:1

• D.O.C. is stock allowance/side (radius)

Feed

1. Feed: Based on effective number of inserts, depending on roughing method
 - Balanced Cutting: 2 effective inserts
 - Stepped Cutting: 1 effective insert
 - Full Profile Cutting: 1 effective insert
2. Under normal rough boring operations, the effective feed rate is about 50% of nose radius

Nose Radius	Feed/IPR	
	Balanced Cutting	Stepped Cutting
.008 (0)	.008-.012	.004-.006
.016 (1)	.014-.016	.006-.008
.031 (2)	.020-.026	.012-.016
.047 (3)	.020-.030	.012-.020

Power Consumption

The power curve of the machine should be consulted and cutting data values adjusted accordingly.

- HP Requirements = MRR x K
- MRR = $d \times \text{SFM} \times \text{IPR} \times 12$
- MRR = metal removal rate, inches³
- d = radial depth of cut, inches
- SFM = surface feet/minute
- IPR = inches/rev

Material	K Factor*
Steel	.750
Alloy Steel	1.000
Cast Iron	.650
Aluminum	.430
High Temp Alloys	2.000

*With positive cutting geometry only

General Rule:

Boring bar should always be smaller than original hole size.

CAUTION

It is very important to allow for clearance between boring bar and rough bore diameter.

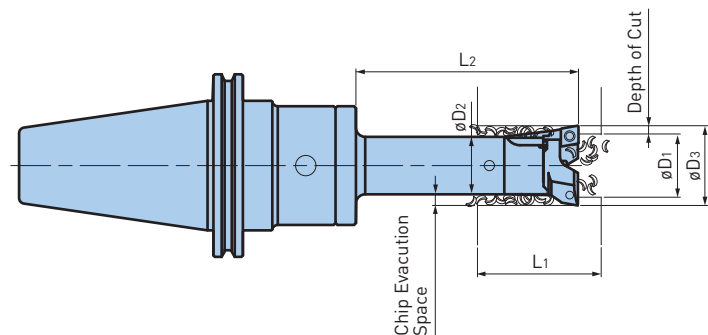

ROUGH BORING TROUBLESHOOTING

Under certain conditions, it may be necessary to modify or adapt recommended cutting data and/or tooling configurations of the application. Below are general solutions to common problems.

Problem	Possible Cause	Remedy
Poor Chip Control	Feed rate too low	Increase feed rate
	Excessive height variation of inserts	Preset tool to max. .0002" variation of both inserts
	Width of chip excessive (D.O.C.)	Preset tool for stepped cutting method
	Excessive stock allowance	Consult cutting data tables
Chatter & Vibration	Excessive speed	Reduce SFM, check cutting data tables
	Extreme length/diameter ratio	Shorten tool to increase stiffness
		Increase boring bar diameter to larger size
		Change boring bar to carbide or heavy metal
	Insert radius too large	Reduce nose radius of insert
	Unstable workpiece	Improve fixture and clamping support
Lead angle on insert holders	Change to 90 degree insert holders (type CC)	
Inserts Chipping or Breaking	Wrong insert	Change to tougher grade of carbide insert
		Use larger radius if available
	Severe interruption	Increase speed, decrease feed
	Chips packing and re-cutting	Check for boring bar/bore diameter clearance
Improve chip control, increase feed		
Poor Tool Life	Wrong insert	Change to higher wear resistant grade
	Excessive cutting speed	Reduce speed
	Inserts chipping	Check stock allowance and feed rate
	Coolant pressure too low	Increase through tool coolant pressure
		Adjust coolant ports of head if available
Chips Not Evacuating	Boring bar diameter too large	Reduce to smaller head and extended range holder
	Excessive stock allowance	Re-set tool for stepped cutting
	Inadequate space below bore	Elevate workpiece from table more
	Poor chip control	See above problem
Insufficient Machine Power	Excessive feed rate	Reduce feed; minimum 25% of insert radius
	Stock allowance excessive	Reset tool for stepped cutting method
	Low machine torque	RPM in area of low spindle torque; increase speed
		RPM in area of gear change; adjust RPM
		Change insert to higher rake angle
	Reduce depth of cut	
Excessive Exit Burr	Excessive feed rate	Reduce feed rate
	CC type insert holders	Use square insert holders with 6 degree lead
	Cutting forces too high	Reduce depth of cut
		Reduce insert radius

CENTRIC CUTTING EDGE

FINE BORING

B.2



FINE BORING **B.2**

FINE BORING HEADS
414-450

FINE BORING HEADS OVERVIEW	414
EWE 2-152E DIGITAL FINE BORING HEAD	416
EWN 2-152E FINE BORING HEAD	417
ACCESSORIES FOR EWE/EWN 2-152 & EWB 2-50	418-425
EWN/EWE INSERT HOLDERS	426-427
OD TURNING HOLDER FOR EWN/EWE	428
SERIES 112 BORING KIT	429
EWE 2-32E DIGITAL FINE BORING HEAD	430
EWN 2-32E & 04-22E FINE BORING HEAD	431
ACCESSORIES EWE/EWN/EWB 2-32	432-437
ACCESSORIES EWN 04-22	438-441
EWN 04-15E FINE BORING HEAD	442
EWN 04-7E FINE BORING HEAD	443
SERIES 112 SPARE PARTS	444-445
SETTING JIG	446
INSERT SELECTION & CUTTING DATA	447-449
GUIDELINES	450

EWE 2-152E DIGITAL



**MAX
10,000
RPM**

Wireless communication for easy readout with the BIG KAISER app: The brandnew EWE fine boring head revolutionates fine boring process. Less operator mistakes, easier setup and a huge diameter range. Accessories of EWE and EWN are fully compatible.

ø.079"-6.000"
CK6



PG. 416

EWN 2-152E

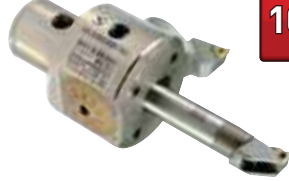

**MAX
10,000
RPM**

Fine boring head with centric boring bars in modular and integral execution for accurate, high performance operations. The head comes with variable length adjustment of the boring bar and large dial disc for parallax-free readout.

ø.079"-6.000"
CK6/CV40/BT40

PG. 417

EWE 2-32E DIGITAL



**MAX
14,000
RPM**

Smallest digital fine boring head with wireless communication to the BIG KAISER app and centric boring bar. Especially manufactured for the use on small machine tools. Accessories of EWN and EWE are fully compatible.

ø.079"-1.260"
CK5



PG. 430

EWN 2-32E



**MAX
14,000
RPM**

Fine boring head with centric boring bar in integral, modular and screw-on execution for precise machining. Developed for the use on machine tools with spindles 30 taper, HSK-A50 and bigger, as well as on lathe machines with driven tools.

ø.079"-1.260"
CK5/ER32

PG. 431

EWN 04-15E



**MAX
20,000
RPM**

Machining of small bores with high speeds on machine tools with spindles HSK-E32 and bigger.

ø.016"-.590"
CK3/ST16

PG. 442

EWN 04-7E



**MAX
30,000
RPM**

World's smallest fine boring head: Thanks to its body diameter of only ø.73", the EWN 04-7E is the perfect solution for micro machining applications.

ø.016"-.276"
CK1/ST6/ST10

PG. 443

CAUTION

Max through-tool coolant pressure is 300 psi.



EWE 2-152E DIGITAL FINE BORING HEAD

RANGE: $\phi.079''$ - $6.000''$

Digital fine boring head in modular and integral execution for accurate, high performance boring operations. With wireless communication to the BIG KAISER app.

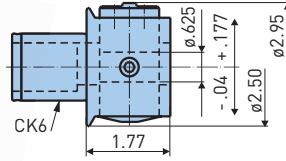

Catalog Number	Reference Number
EWE2-152ECK6	10.112.120

BIG KAISER APP

Enhances user friendliness while assembling and running our boring tools. The app helps operators to determine optimal cutting parameters, manuals and provides a history of all adjustments made with an EWE boring head.

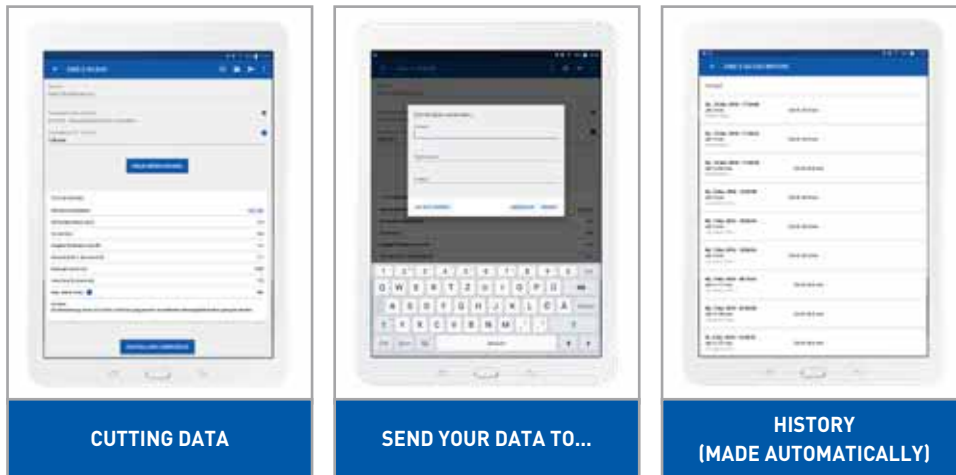

Ways the App Will Support Your Daily Challenges

- Choose your tool
- Type in your application values
- Calculate cutting data
- Adjust machine and make a measuring bore
- Infeed tool with the diameter of the measuring bore
- Make the bore

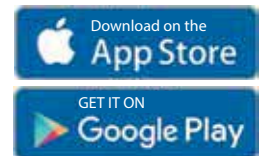

EWN 2-152 FINE BORING HEAD

RANGE: $\phi.079''$ - $6.000''$

Fine boring heads in modular and integral execution for accurate, high performance boring operations on machine tools with spindles ISO 40, HSK-A63, BIG CAPTO C6 and bigger.

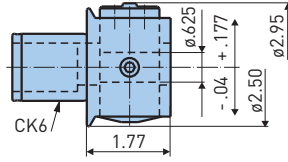

Catalog Number	Reference Number
EWN2-152ECK6	10.112.118

OTHER EXECUTIONS

<p>EWN2-152ECV40 10.112.134</p> 	<p>EWN2-152EBT40 10.112.132</p> 	<p>EWB2-50ECK6 10.112.117</p>  <p>Balanceable Max Bore Diameter: 1.970"</p>
<p>EWN2-152EHSK-A63 10.112.133</p> 	<p>EWN2-152EC6 10.470.118</p> 	

BORING HEAD CATALOG NUMBER

REFERENCE NUMBER

EWE2-152CK6

10.112.120

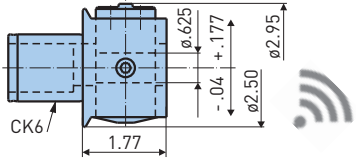

EWN2-152ECK6

10.112.118

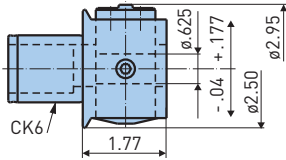

EWN2-152ECV40

10.112.134

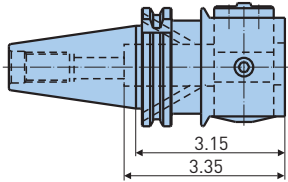

EWN2-152EBT40

10.112.132

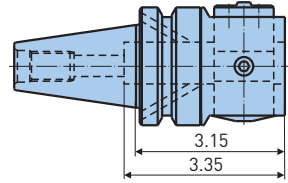

EWB2-50ECK6

10.112.117

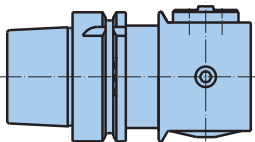
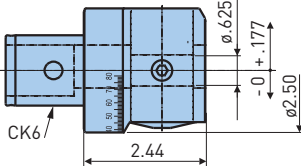

- Additional integral types with HSK and C6 available upon request consult BIG KAISER engineering for information & technical specification
- $\phi D = \text{full range } +.35"/\phi$

 Carbide tool holders

- Items marked \spadesuit are recommended for EWB 2-50E

ACCESSORIES

		APPLYING	
INSERTS	PG. 506	ADVICE	PG. 447

RB5/8"-4-100
10.613.524 \spadesuit

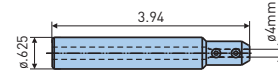

RB5/8"-4
10.613.504

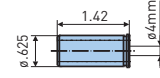

RB5/8"-3.5-100
10.613.522 \spadesuit

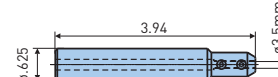

RB5/8"-4.5-100
10.613.523 \spadesuit

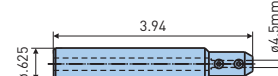

RB5/8"-5-100
10.613.525 \spadesuit

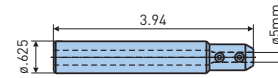

RB5/8"-5
10.613.505

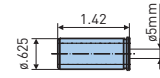

RB5/8"-6-100
10.613.526 \spadesuit

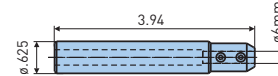

RB5/8"-6
10.613.506

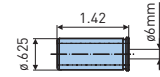

RB5/8"-7-100
10.613.527 \spadesuit

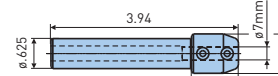

RB5/8"-7
10.613.507

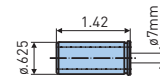

RB5/8"-8-100
10.613.528 \spadesuit

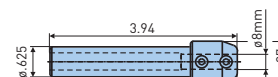

RB5/8"-8
10.613.508

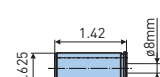

RB5/8"-9-100
10.613.529 \spadesuit

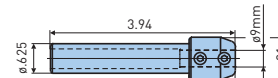

RB5/8"-9
10.613.509

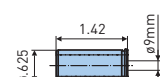

RB5/8"-10-100
10.613.530 \spadesuit

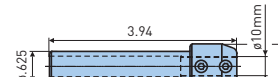

RB5/8"-10
10.613.510

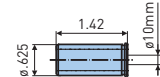

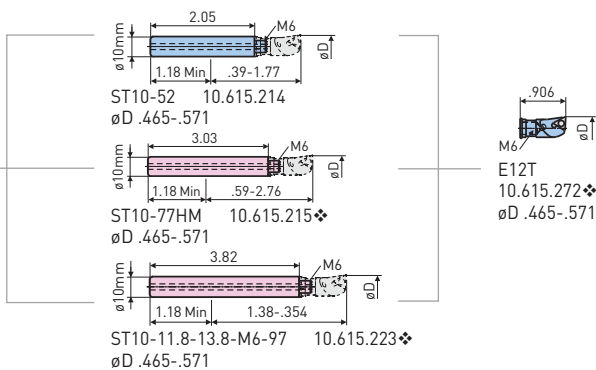
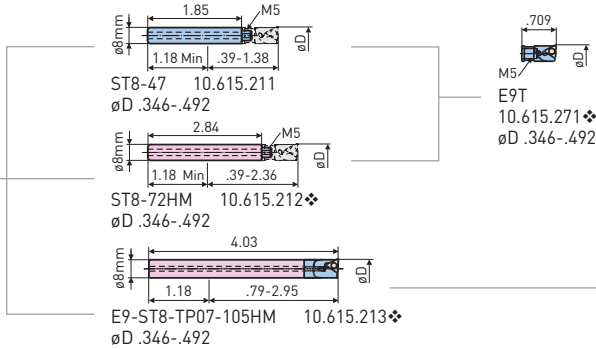
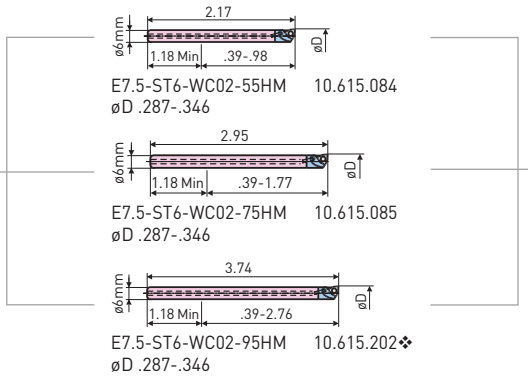
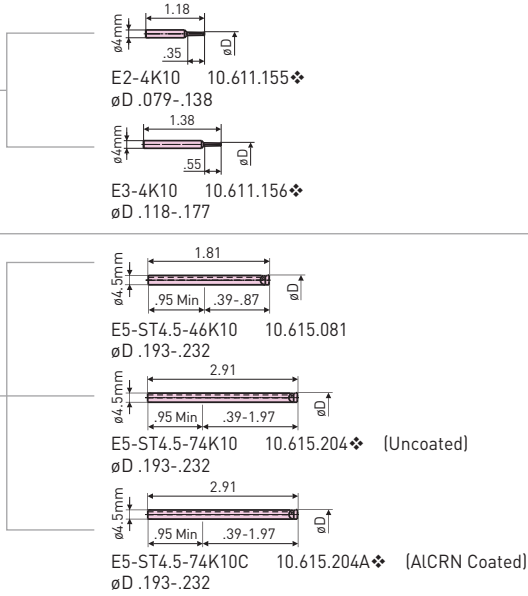
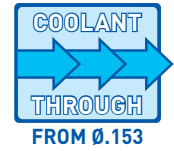

FIXED TOOL HOLDER

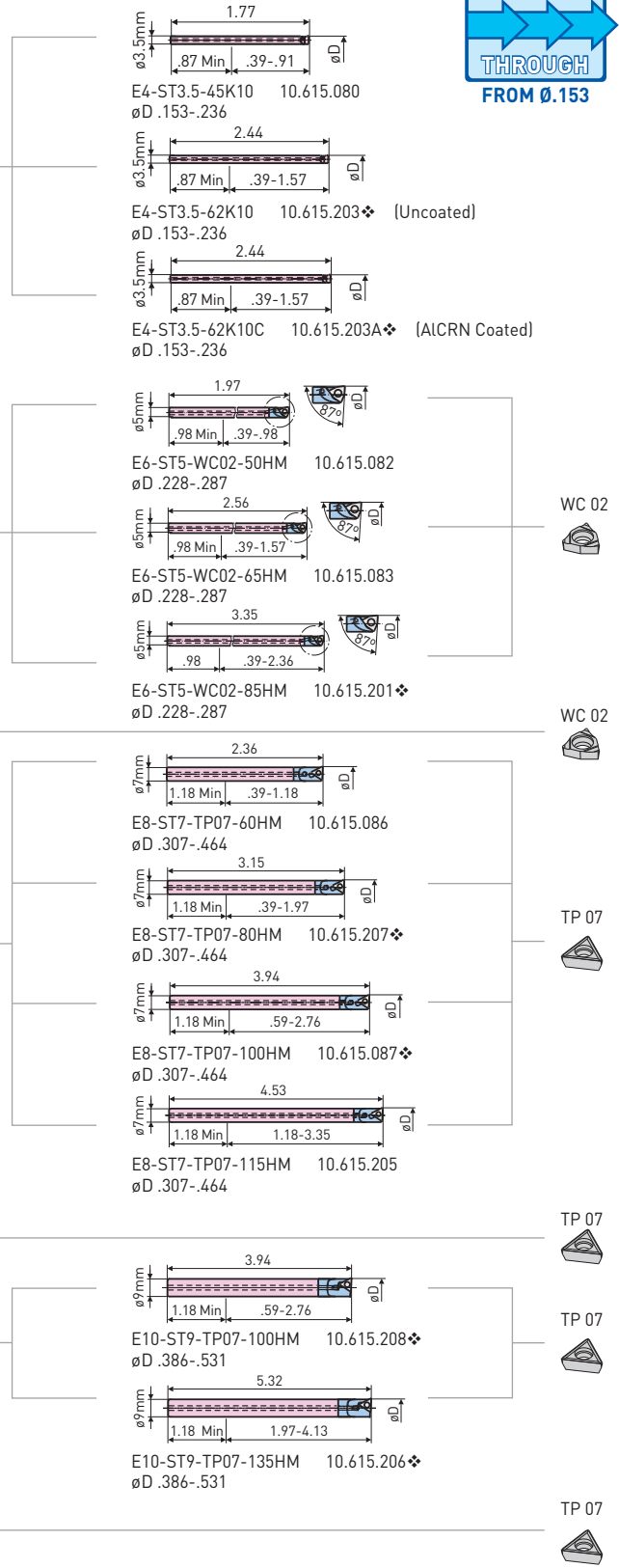

WC 02

WC 02

TP 07

TP 07

TP 07

TP 07

BORING HEAD CATALOG NUMBER **REFERENCE NUMBER**

EWE2-152CK6 10.112.120

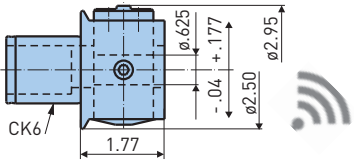

EWN2-152ECK6 10.112.118

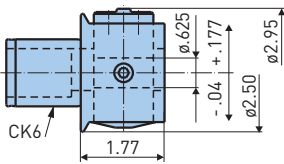

EWN2-152ECV40 10.112.134

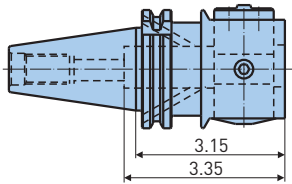

EWN2-152EBT40 10.112.132

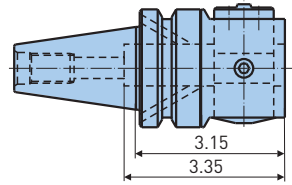

EWB2-50ECK6 10.112.117

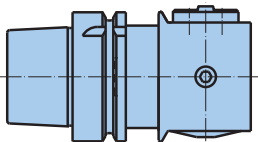
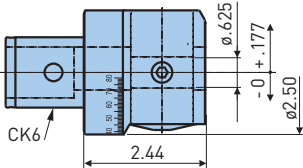

- Additional integral types with HSK and C6 available upon request consult BIG KAISER engineering for information & technical specification
- ϕD = full range $+0.35"/\phi$

 Carbide tool holders

• Items marked  are recommended for EWB 2-50E

ACCESSORIES

 INSERTS PG. 506	APPLICATION ADVICE PG. 447
---	----------------------------------

RB5/8"-9
10.613.509

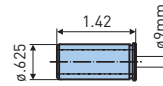

RB5/8"-11
10.613.511

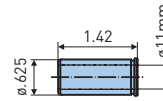

RB5/8"-13
10.613.513

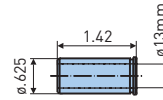

ADJUSTABLE TOOL HOLDER

The adjustable tool holder allows the coarse diameter setting on the insert holder. This leads to the possibility to machine bores from $\phi .386$ - 2.13 with the tool holder in the center position and as a result, with the best possible balancing of the tool combination.

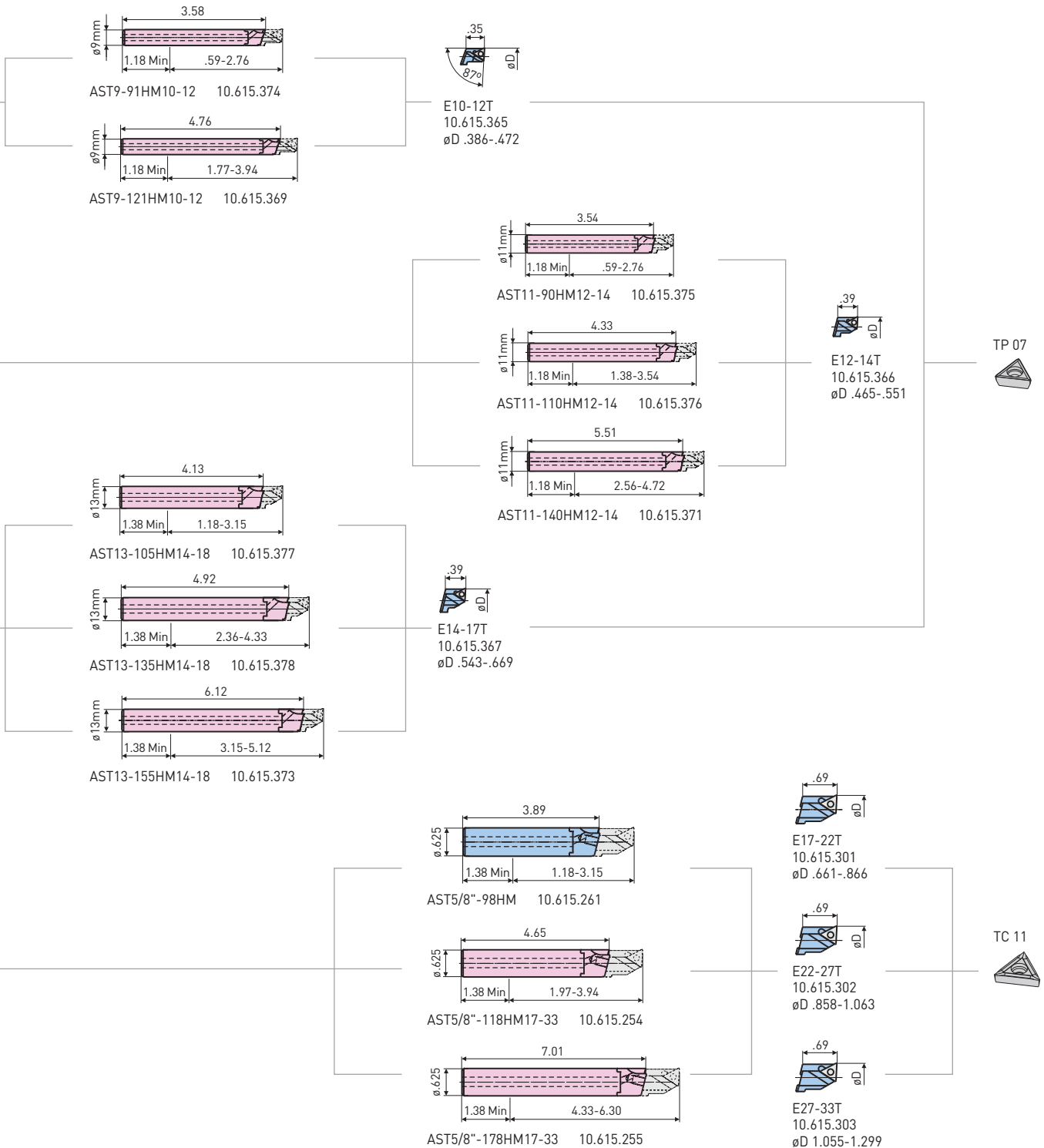

BORING HEAD CATALOG NUMBER **REFERENCE NUMBER**

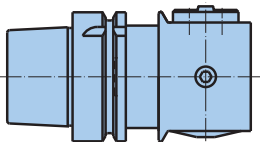
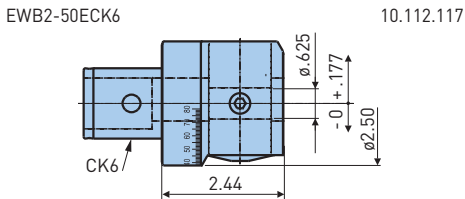
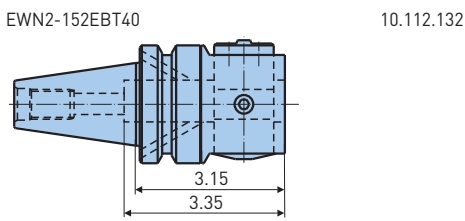
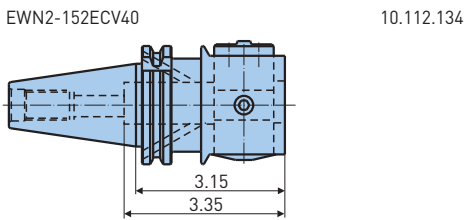
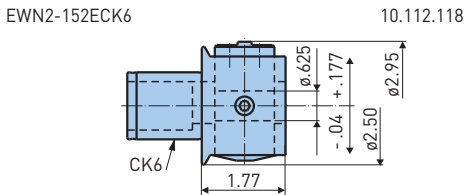
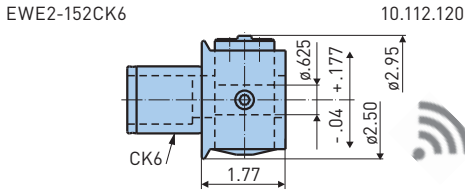

- Additional integral types with HSK and C6 available upon request consult BIG KAISER engineering for information & technical specification
- $\phi D = \text{full range } +.35''/\phi$

 Carbide tool holders

- Items marked  are recommended for EWB 2-50E

ACCESSORIES

 INSERTS PG. 506	APPLICATION ADVICE PG. 447
---	----------------------------------

RB5/8"-11
10.613.511 

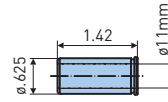

RB5/8"-12
10.613.512 

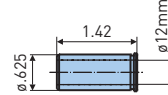

RB5/8"-13
10.613.513 

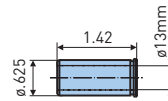

RB5/8"-14
10.613.514 

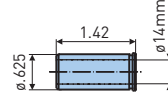

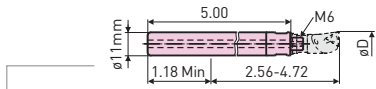

ST11-127HM 10.615.250❖
øD .465-.571

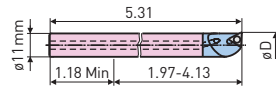

E12-ST11-TP07-135HM 10.615.209❖
øD .465-.571

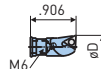

E12T
10.615.272❖
øD .465-.571

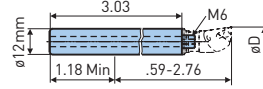

ST12-77 10.615.218
øD .543-.650

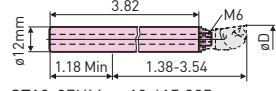

ST12-97HM 10.615.225
øD .543-.650

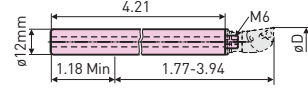

ST12-107HM 10.615.219❖
øD .543-.650

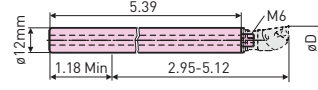

ST12-137HM 10.615.224❖
øD .543-.650

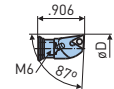

E14T
10.615.273❖
øD .543-.650

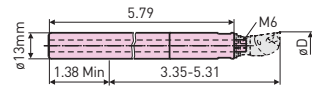

ST13-147HM 10.615.251❖
øD .543-.650

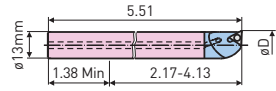

E14-ST13-TP07-140HM 10.615.210❖
øD .543-.650

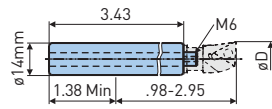

ST14-87 10.615.232
øD .582-.701

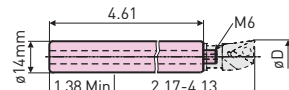

ST14-117HM 10.615.233❖
øD .582-.701

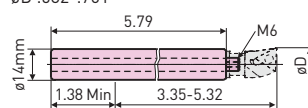

ST14-147HM 10.615.221
øD .582-.701

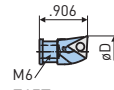

E15T
10.615.280❖
øD .582-.689

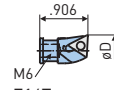

E16T
10.615.281❖
øD .622-.701

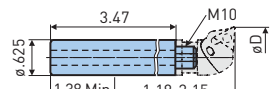

ST5/8"-88 10.615.236
øD .701-1.97

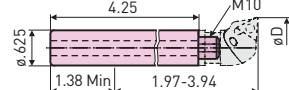

ST5/8"-88HM 10.615.237❖
øD .701-1.97

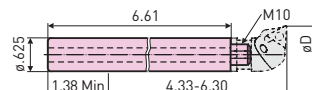

ST5/8"-168HM 10.615.238❖
øD .701-1.97

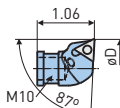

E18T
10.615.282❖
øD .701-.780

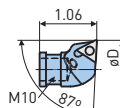

E24T
10.615.290❖
øD .937-.976

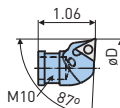

E28T
10.615.284❖
øD 1.094-1.252

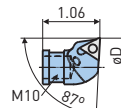

E40T
10.615.287❖
øD 1.567-1.764

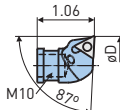

E20T
10.615.289❖
øD .780-.858

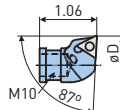

E25T
10.615.288❖
øD .976-1.016

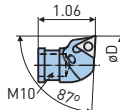

E32T
10.615.285❖
øD 1.252-1.409

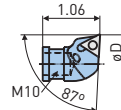

E45T
10.615.292❖
øD 1.764-2.126

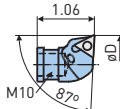

E22T
10.615.283❖
øD .858-.937

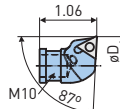

E26T
10.615.291❖
øD 1.016-1.094

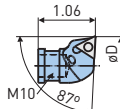

E36T
10.615.286❖
øD 1.409-1.567

AST5/8"-103 10.615.263
 øD 1.252-2.125

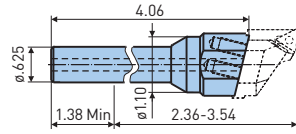

AST5/8"-123HM40-54 10.615.259
 øD 1.252-2.125

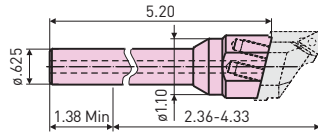

AST5/8"-173HM40-54 10.615.260
 øD 1.252-2.125

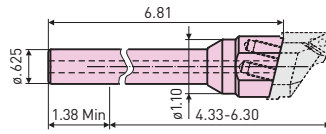

AST5/8"-72 10.615.389
 øD 2.125-3.150

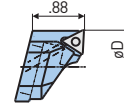
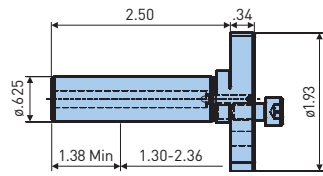

E32-40T
 10.615.304
 øD 1.252-1.575

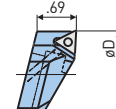

E40-54T
 10.615.305
 øD 1.567-2.125

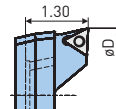

E54-80T
 10.615.306
 øD 2.125-3.150

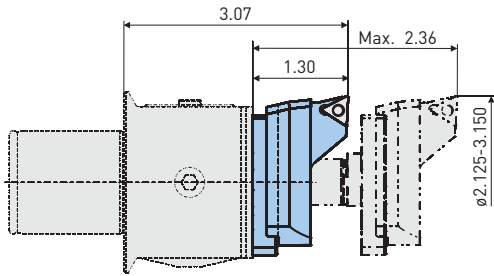

Carbide tool holders

ACCESSORIES

INSERTS
 PG. 506

APPLICATION
ADVICE
 PG. 447

CHAMFERING RINGS

Chamfering rings for tool holders made of steel and carbide ø12mm and ø.625, for 45° chamfering right after boring, without tool change.

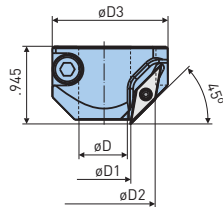

Catalog Number	Reference Number	Dimensions				
		øD	øD1	øD2	øD3	
CR13-27ST12V	10.615.394	12mm	.496	1.090	1.38	VC 11
CR17-31ST5/8"	10.615.393	.625	.654	1.250	1.56	

ACCESSORIES

INSERTS
 PG. 506

APPLICATION
ADVICE
 PG. 447

90° INSERT HOLDERS, CC TYPE

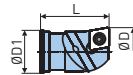

Catalog Number	Reference Number	øD1	L	øD	
E12C	11.689.810	10mm	.906	.465-.571	CC 06
E14C	11.689.811	12mm	.906	.543-.650	
E16C	11.689.812	14mm	.906	.622-.728	
E18C	11.689.813	.625	1.06	.701-.807	CC 09
E20C	11.689.814	.625	1.06	.780-.886	
E22C	11.689.815	.625	1.06	.858-.965	CC 09
E24C	11.689.816	.625	1.06	.937-1.043	
E26C	11.689.818	.625	1.06	1.016-1.122	
E28C	11.689.819	.625	1.06	1.094-1.280	
E30C	11.689.820	.625	1.06	1.173-1.358	
E32C	11.689.821	.625	1.06	1.252-1.437	
E36C	11.689.822	.625	1.06	1.409-1.594	
E40C	11.689.823	.625	1.06	1.567-1.772	
E45C	11.689.824	.625	1.06	1.764-2.126	

ACCESSORIES

INSERTS
 PG. 506

APPLICATION
ADVICE
 PG. 447

BACK BORING CATALOG NUMBER

ST10-52 10.615.214
øD .622-.807

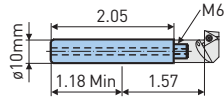

ST10-77HM 10.615.215
øD .622-.807

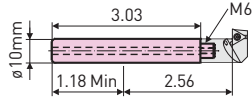

ST10-97HM 10.615.223
øD .622-.807

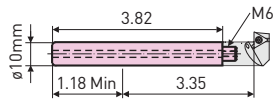

ST12-77HM 10.615.218
øD .780-1.016

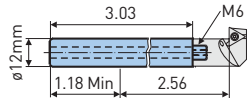

ST12-107HM 10.615.219
øD .780-1.016

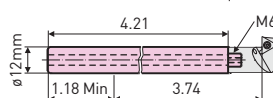

ST12-137HM 10.615.224
øD .780-1.016

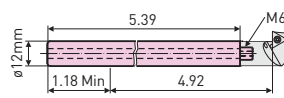

ST14-87HM 10.615.232
øD 1.016-1.134

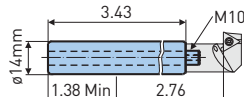

ST14-117HM 10.615.233
øD 1.016-1.134

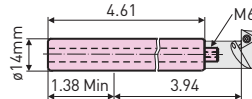

ST14-147HM 10.615.221
øD 1.016-1.134

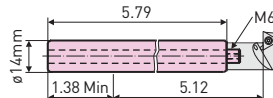

ST5/8"-88 10.615.236
øD 1.134-1.752

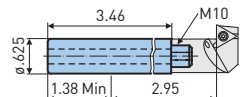

ST5/8"-108HM 10.615.237
øD 1.134-1.752

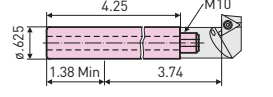

ST5/8"-168HM 10.615.238
øD 1.134-1.752

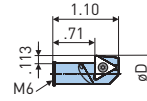
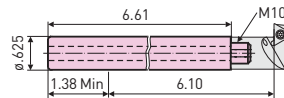

E16T-BB
11.689.801
øD .622-.728
Min Entry Dia. .512

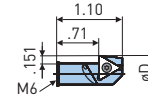

E18T-BB
11.689.802
øD .701-.807
Min Entry Dia. .547

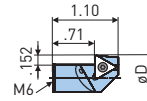

E20T-BB
11.689.803
øD .780-.898
Min Entry Dia. .626

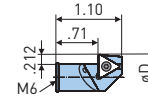

E20T-BB
11.689.804
øD .898-1.016
Min Entry Dia. .685

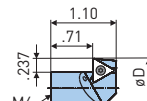

E26T-BB
11.689.805
øD 1.016-1.134
Min Entry Dia. .783

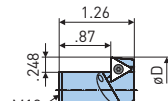

E29T-BB
11.689.806
øD 1.134-1.319
Min Entry Dia. .882

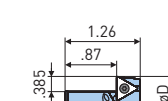

E36T-BB
11.689.808
øD 1.409-1.594
Min Entry Dia. 1.020

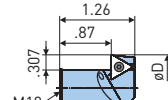

E32T-BB
11.689.807
øD 1.252-1.437
Min Entry Dia. .941

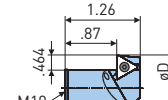

E40T-BB
11.689.809
øD 1.567-1.752
Min Entry Dia. 1.098

TC 11



ACCESSORIES



REDUCTIONS

Catalog Number	Reference Number	øD	Catalog Number	Reference Number	øD
ST16-10-32	10.615.230	.465-.571	ST16-12-32	10.615.231	.543-.728

EXTENSIONS

Catalog Number	Reference Number	øD	Catalog Number	Reference Number	øD
ST12-18	10.615.220	.543-.650	ST16-25	10.615.228	.701-1.969

INSERT HOLDERS FOR EWN/EWE

RANGE: $\varnothing 3.150''$ - $6.000''$

EWE2-152ECK6

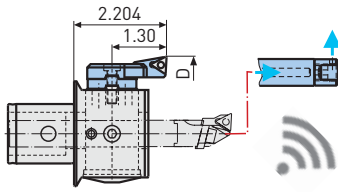

EWN2-152ECK6

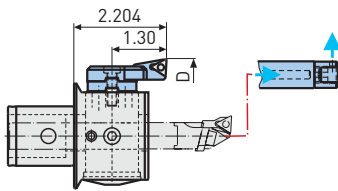

EWN2-152ECV40

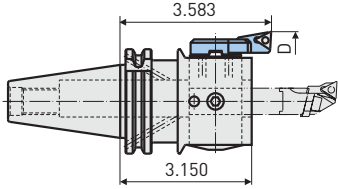

EWN2-152EBT40

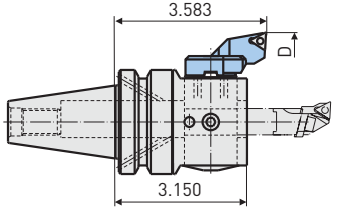

ACCESSORIES



	Parts	Catalog Number	Reference Number	Insert	$\varnothing D$
	Insert Holder	EK80-104T	10.626.908		3.150-3.622
	Spacer	DD30-6	10.626.907		3.622-4.094
	Insert Holder	EK80-104T	10.626.908		
	Insert Holder*	EK104-128T	10.626.909		4.094-4.567
	Spacer*	DD30-6	10.626.907		4.567-5.039
	Insert Holder	EK104-128T	10.626.909		
	Insert Holder*	EK128-152T	10.626.910		5.039-5.512
	Spacer*	DD30-6	10.626.907		
	Insert Holder	EK128-152T	10.626.910		5.512-6.000
	Tool Holder	ST5/8"-88	10.615.236		
	Coolant Nozzle	CN2-50	10.615.392		

*Also suitable for back boring.

BALANCING RINGS

After removing the front cover plate, the balancing rings can be mounted on to the boring heads. The imbalance has to be measured on a balancing machine. The correction of the imbalance is done by moving the scale rings.

Catalog Number	Reference Number
BR2-152	10.112.806

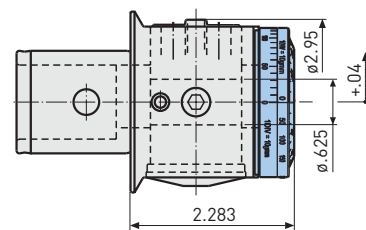
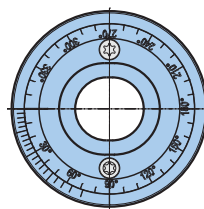
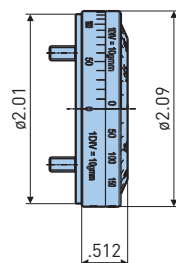

FACE GROOVING HOLDERS FOR EWN/EWE

RANGE: ϕ .551"-2.083"

Tool holder, insert holder, and grooving insert are made for face grooving with the fine boring head EWN/EWE 2-152.

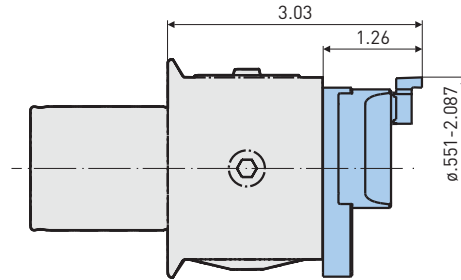

TOOL & INSERT HOLDER

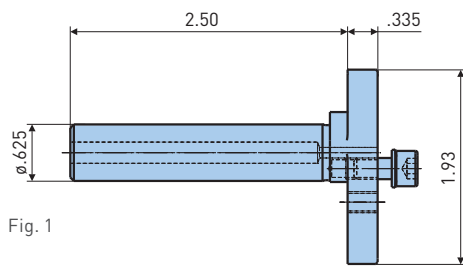

Fig. 1

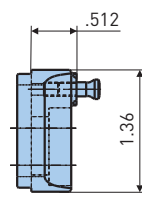
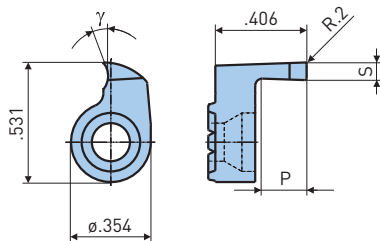

Fig. 2

Catalog Number	Reference Number	Fig.	ϕ D
AST5/8"-72	10.615.389	1	.551-2.087
FGH14-54	10.615.388	2	

GROOVING INSERTS

For all materials



Catalog Number	Reference Number	S	P	γ
RD1420P30C	10.958.501	.079	.197	20°
RD1425P30C	10.958.502	.098		
RD1430P30C	10.958.503	.118		

SERIES 112 BORING KIT

DIAMETER RANGE: \varnothing .350"-1.000"

Series 112 high precision boring head kit contains all components needed for small diameter bores from \varnothing .350" to \varnothing 1.000", including inserts and wrenches. The entire kit, including molded plastic carrying case with foam inlay to protect the precision instruments, provides considerable savings over what the boring head, reduction bushings, shanks and other components cost when ordered separately.



Adapter Size	Catalog Number	Reference Number	Boring Head	
			Analog Dial	Digital Display
CK6	EWN2-152ECK6-9-26SET	11.112.911*	10.112.118	—
	EWE2-152ECK6-9-26SET	11.112.919**	—	10.112.120
BT40	EWN2-152EBT40-9-26SET	11.112.914	10.112.132	—
CAT40	-152ECV40-9-26SET	11.112.913	10.112.134	—
HSK-A63	-152EHSKA63-9-26SET	11.112.912	10.112.133	—

*Order shank separately for this kit

**Digital option

CONTENTS

REDUCTION BUSHING

Catalog Number	Reference Number
RB5/8"-8	10.613.508
-10	10.613.510
-12	10.613.512
-14	10.613.514

INSERT HOLDERS

Catalog Number	Reference Number
E9T	10.615.271
E12T	10.615.272
E14T	10.615.273
E16T	10.615.281
E18T	10.615.282
E22T	10.615.283

STEEL BORING BARS

Catalog Number	Reference Number
ST8-47	10.615.211
ST10-52	10.615.214
ST12-77	10.615.218
ST14-87	10.615.232
ST5/8"-88	10.615.236

INSERTS (5 PIECES)

Catalog Number	Reference Number
TPGT070202-P10CT	10.651.802
TCMT110202-P10CT	11.655.322

SERIES 112 BORING KIT

DIAMETER RANGE: \varnothing .700"-6.000"

Enormous boring range with just one boring head! Thanks to a new insert holder as well as carefully selected accessories the latest "ready to go" tool kit enables precise boring in the diameter range of \varnothing .700"-6.000".



Catalog Number	Reference Number	Boring Head
EWN2-152E-18-152SET	10.112.937A	Analog Head
EWE2-152E-18-152SET	10.112.937E	Digital Head

CONTENTS

BORING HEAD

Catalog Number	Reference Number
EWN2-152E-18-152SET	10.112.118
EWE2-152E-18-152SET	10.112.120

STEEL BORING BARS

Catalog Number	Reference Number
ST5/8"-88	10.615.389
AST5/8"-72	10.615.236

INSERT HOLDERS

Catalog Number	Reference Number
E18T	10.615.282
E25T	10.615.288
E32T	10.615.285
E40T	10.615.287
E45T	10.615.292
E54-80T	10.615.306

OUTBOARD HOLDERS & ACCESSORIES

Catalog Number	Reference Number
DD30-6	10.626.907
EK80-104T	10.626.908
EK104-128T	10.626.909
EK128-152T	10.626.910
CN2-50	10.615.392

INSERTS (10 PIECES)

Catalog Number	Reference Number
TCGT110204-M10C	10.655.389

CASE

Catalog Number	Reference Number
CASE-EWN2-150CK6	10.671.150

EWE 2-32E Digital Fine Boring Head

RANGE: ϕ .079"-1.260"

The EWE 2-32 is the smallest digital fine boring head with centre insert holder. It is especially suitable for the use on small machines.

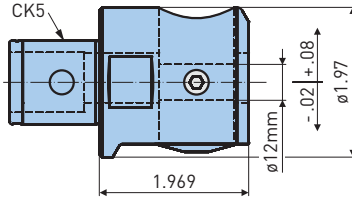

Catalog Number	Reference Number
EWE2-32ECK5	10.112.320

BIG KAISER APP

Enhances user friendliness while assembling and running our boring tools. The app helps operators to determine optimal cutting parameters, manuals and provides a history of all adjustments made with an EWE boring head.

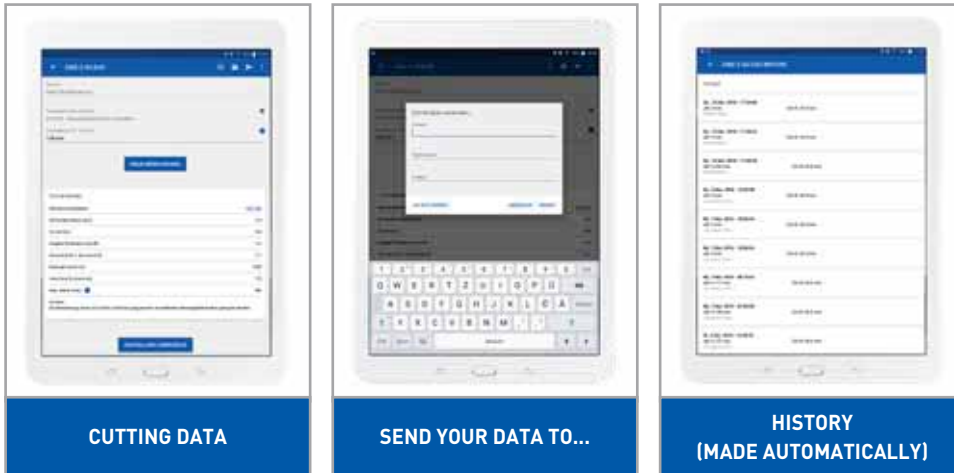

FINE BORING B.2

Ways the App Will Support Your Daily Challenges

- Choose your tool
- Type in your application values
- Calculate cutting data
- Adjust machine and make a measuring bore
- Infeed tool with the diameter of the measuring bore
- Make the bore

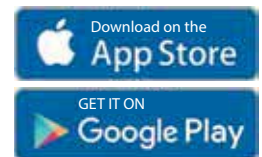

EWN 2-32E FINE BORING HEAD

RANGE: ϕ .079"-1.260"

Fine boring head in integral, modular, and screw-on execution for the precise machining of bores.

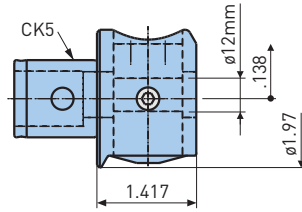

Catalog Number	Reference Number
EWN2-32ECK5	10.112.313

OTHER EXECUTIONS

EWB2-32ECK5
10.112.315



Balanceable

EWN2-32ES32
10.112.317



ER25

EWN 04-22E FINE BORING HEAD

RANGE: ϕ .016"-.866"

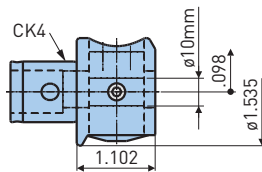

Catalog Number	Reference Number
EWN04-22ECK4	10.112.216

OTHER EXECUTIONS

EWN04-22EES25
10.112.215



ER25

BORING HEAD CATALOG NUMBER

REFERENCE NUMBER

EWE2-32ECK5

10.112.320

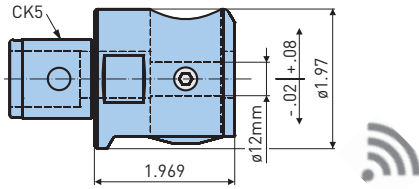

EWN2-32ECK5

10.112.313

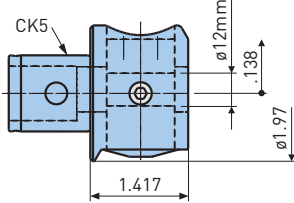

EWB2-32ECK5

10.112.315

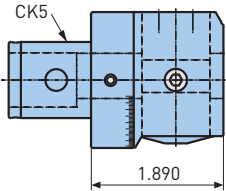

EWN2-32EES32 (ER32)

10.112.317

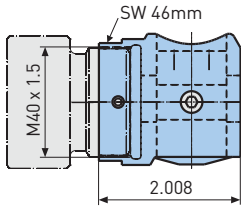

SLEEVE FOR ER TOOL HOLDER

	Catalog Number	Reference Number	A1	ER
	TB-ES32-ES25	10.112.353	M25 x 1.5	ER25
	-ES16	10.112.385	M22 x 1.5	ER16

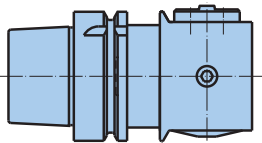

- Additional integral types with HSK and C6 available upon request consult BIG KAISER engineering for information & technical specification
- EWN2-32E: $\phi D = \text{full range} + .276/\phi$
- EWE2-32E: $\phi D = \text{full range} + .157/\phi$

Carbide tool holders

- For EWB2-32E only use items marked \diamond

RB12-4-84
10.613.324 \diamond

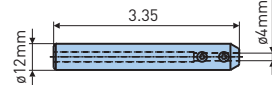

RB12-4
10.613.304 \diamond

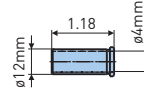

RB12-3.5-85
10.613.323 \diamond

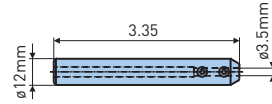

RB12-4.5-85
10.613.326 \diamond

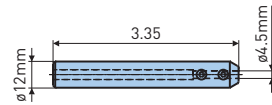

RB12-5-85
10.613.325 \diamond

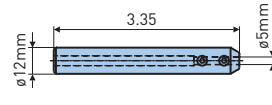

RB12-5
10.613.305 \diamond

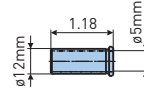

RB12-6-85
10.613.327 \diamond

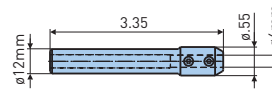

RB12-6
10.613.306 \diamond

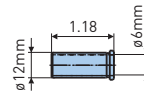

RB12-7
10.613.307 \diamond

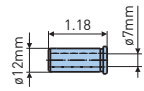

RB12-8
10.613.308 \diamond

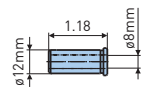

ACCESSORIES



INSERTS
PG. 506



APPLICATION
ADVICE
PG. 447



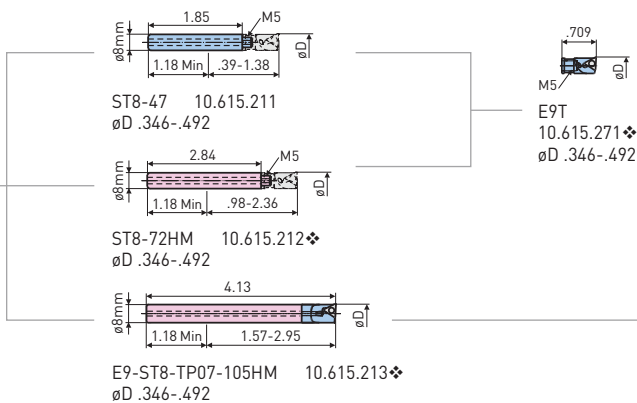
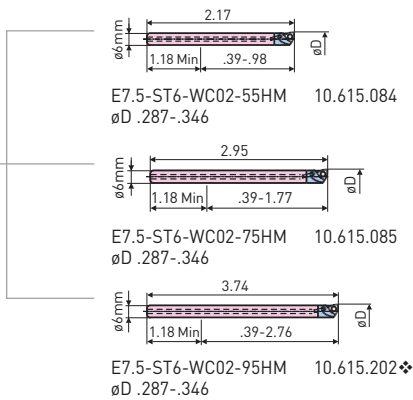
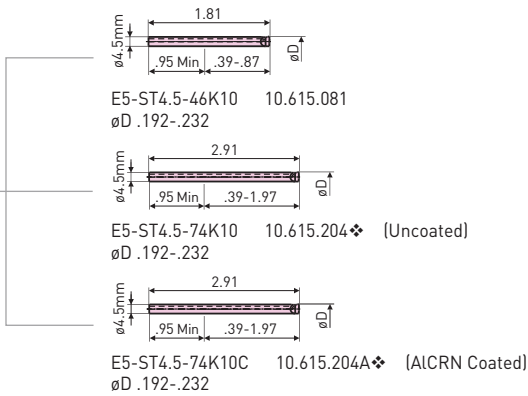
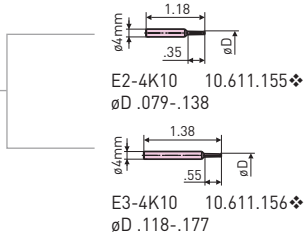

FIXED TOOL HOLDER

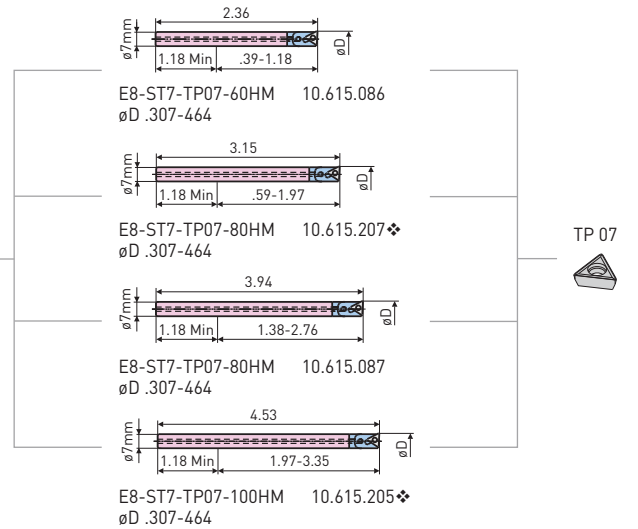
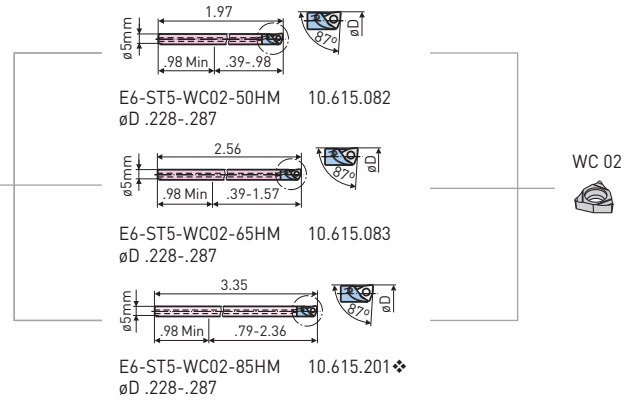
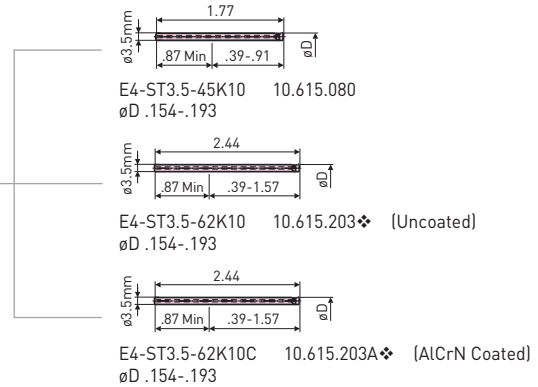

BORING HEAD CATALOG NUMBER

REFERENCE NUMBER

EWE2-32ECK5

10.112.320

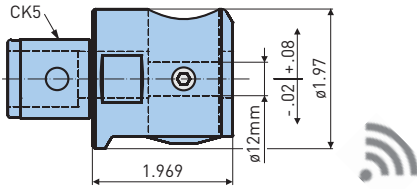

EWN2-32ECK5

10.112.313

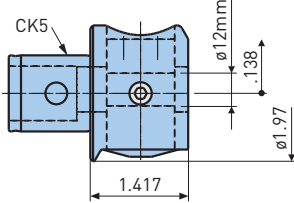

EWB2-32ECK5

10.112.315

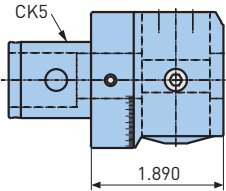

EWN2-32EES32 (ER32)

10.112.317

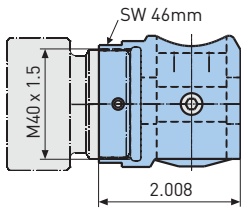

RB12-9
10.613.309

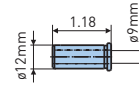

RB12-10
10.613.310

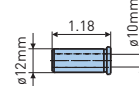

SLEEVE FOR ER TOOL HOLDER

	Catalog Number	Reference Number	A1	ER
	TB-ES32-ES25	10.112.353	M25 x 1.5	ER25
	-ES16	10.112.385	M22 x 1.5	ER16

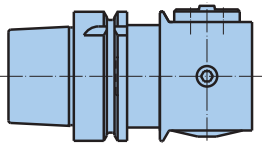

- Additional integral types with HSK and C6 available upon request consult BIG KAISER engineering for information & technical specification
- EWN2-32E: $\phi D = \text{full range} + .27/\phi$
- EWE2-32E: $\phi D = \text{full range} + .157/\phi$

Carbide tool holders

- For EWB2-32E only use items marked

ACCESSORIES

INSERTS PG. 506	APPLICATION ADVICE PG. 447

ADJUSTABLE TOOL HOLDER

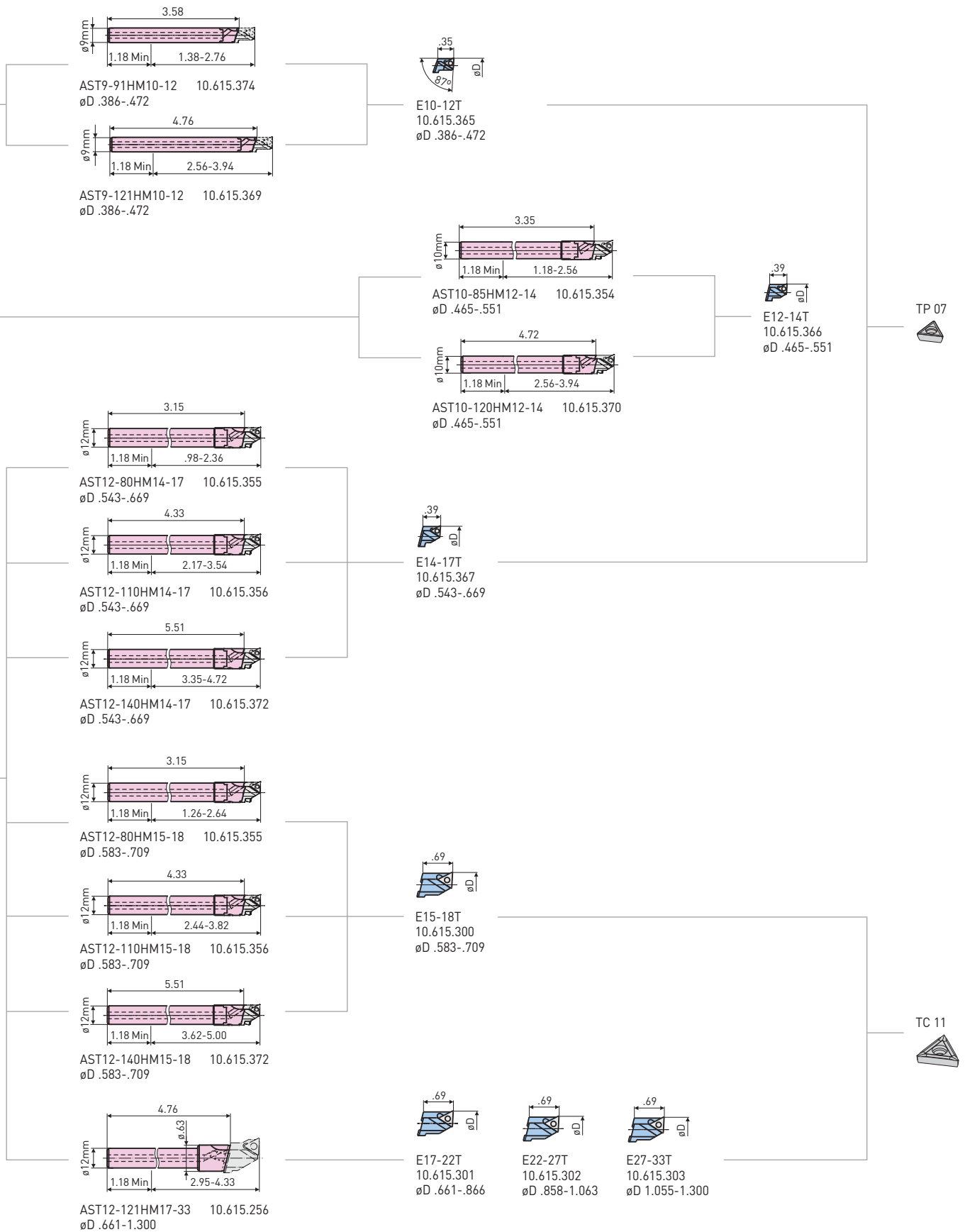

BORING HEAD CATALOG NUMBER

REFERENCE NUMBER

EWE2-32ECK5

10.112.320

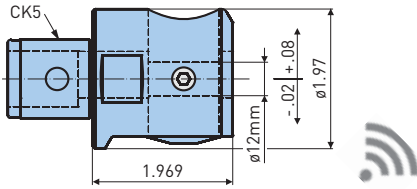

RB12-9
10.613.309

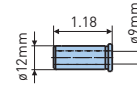

EWN2-32ECK5

10.112.313

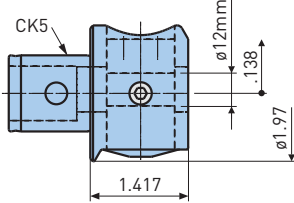

RB12-10
10.613.310

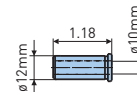

EWB2-32ECK5

10.112.315

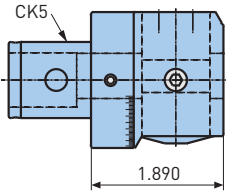

EWN2-32EES32 (ER32)

10.112.317

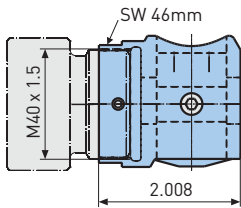

SLEEVE FOR ER TOOL HOLDER

	Catalog Number	Reference Number	A1	ER
	TB-ES32-ES25	10.112.353	M25 x 1.5	ER25
-ES16	10.112.385	M22 x 1.5	ER16	

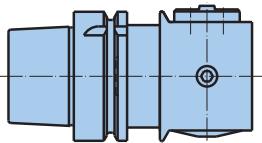

- Additional integral types with HSK and C6 available upon request consult BIG KAISER engineering for information & technical specification
- EWN2-32E: $\phi D = \text{full range} + .276/\phi$
- EWE2-32E: $\phi D = \text{full range} + .157/\phi$

Carbide tool holders

- For EWB2-32E only use items marked

ACCESSORIES

 INSERTS PG. 506	 APPLICATION ADVICE PG. 447
-------------------------------	---

FIXED TOOL HOLDER

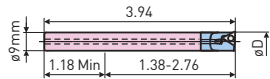

E10-ST9-TP07-100HM 10.615.208❖
øD .394-.465

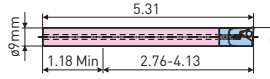

E10-ST9-TP07-135HM 10.615.206❖
øD .394-.465

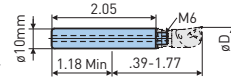

ST10-52 10.615.214
øD .465-.543

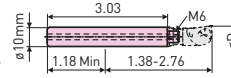

ST10-77HM 10.615.215❖
øD .465-.543

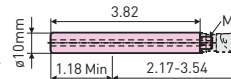

ST10-97HM 10.615.223❖
øD .465-.543

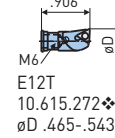

E12T 10.615.272❖
øD .465-.543

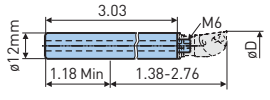

ST12-77 10.615.218
øD .465-.622

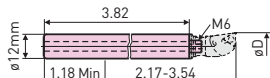

ST12-97HM 10.615.225❖
øD .465-.622

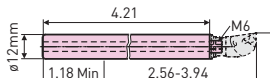

ST12-107HM 10.615.219
øD .583-.701

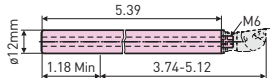

ST12-137HM 10.615.224❖
øD .583-.701

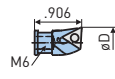

E14T 10.615.273❖
øD .543-.622

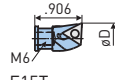

E15T 10.615.280❖
øD .583-.661

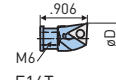

E16T 10.615.281❖
øD .622-.701

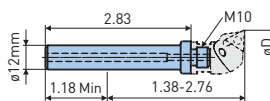

ST12-16-72 10.615.234
øD .701-1.260

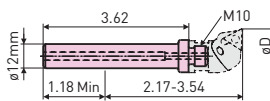

ST12-16-92HM 10.615.243❖
øD .701-1.260

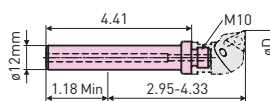

ST12-16-112HM 10.615.239❖
øD .701-1.260

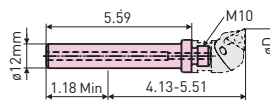

ST12-16-142HM 10.615.240❖
øD .701-1.260

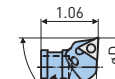

E18T 10.615.282❖
øD .701-.780

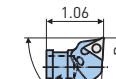

E24T 10.615.290❖
øD .937-.976

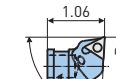

E28T 10.615.284❖
øD 1.094-1.260

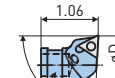

E20T 10.615.289❖
øD .780-.858

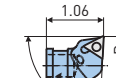

E25T 10.615.288❖
øD .976-1.016

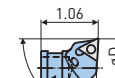

E22T 10.615.283❖
øD .858-.937

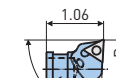

E26T 10.615.291❖
øD 1.016-1.094



BORING HEAD CATALOG NUMBER

REFERENCE NUMBER

EWN04-22ECK4

10.112.216

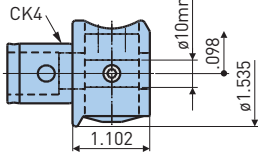

EWN04-22EES25 (ER25)

10.112.215

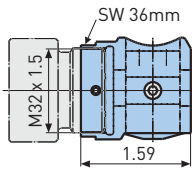

RB10-4
10.613.204

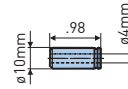

RB10-3.5
10.613.202

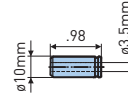

RB10-4.5
10.613.203

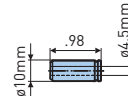

RB10-5
10.613.205

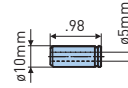

RB10-6
10.613.206

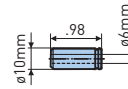

RB10-7
10.613.207

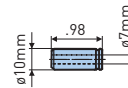

RB10-8
10.613.208

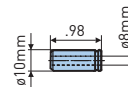

SLEEVE FOR ER TOOL HOLDER

	Catalog Number	Reference Number	A1	ER
	TB-ES25-ES20	10.112.271	M25 x 1.5	ER25
	-ES16	10.112.272	M22 x 1.5	ER16

Carbide tool holders

• For EWB2-32E only use items marked ❖

ACCESSORIES

	INSERTS PG. 506	
	APPLICATION ADVICE PG. 447	

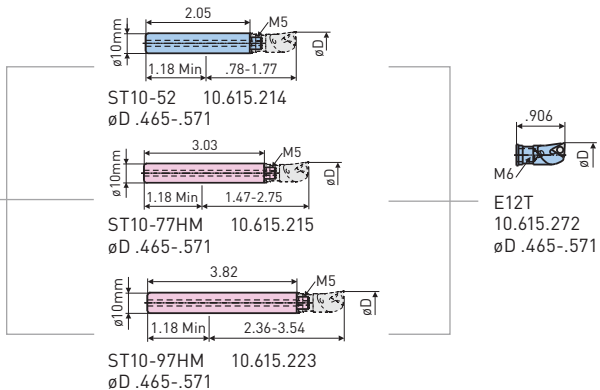
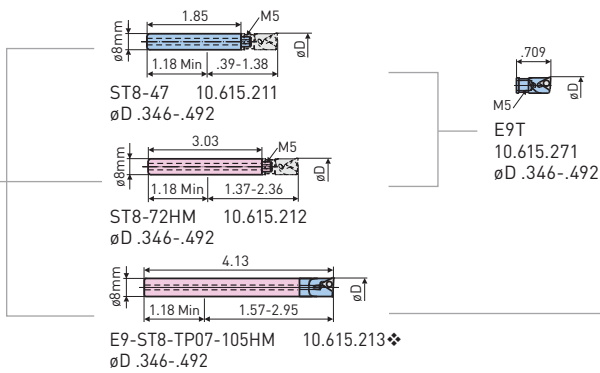
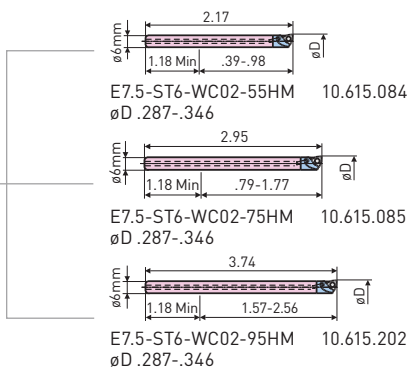
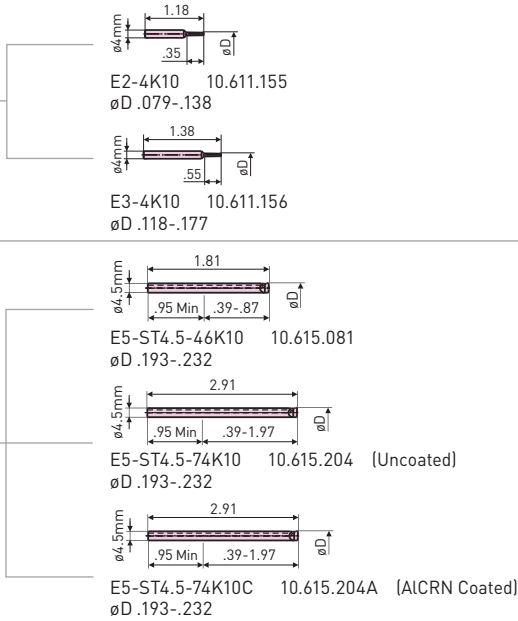

FIXED TOOL HOLDER

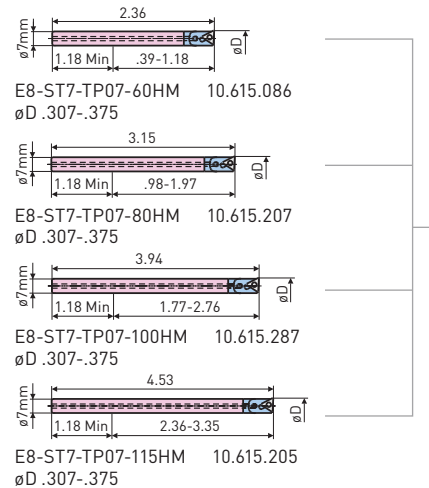
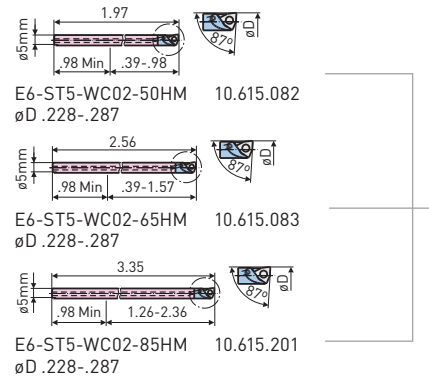
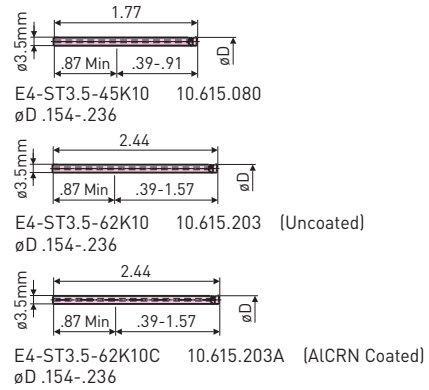

**BORING HEAD
CATALOG NUMBER**

REFERENCE NUMBER

EWN04-22ECK4

10.112.216

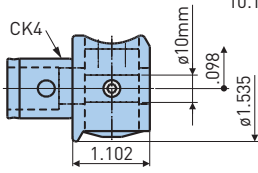

EWN04-22EES25 (ER25)

10.112.215

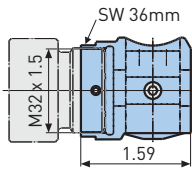

SLEEVE FOR ER TOOL HOLDER

	Catalog Number	Reference Number	A1	ER
	TB-ES25-ES20	10.112.271	M25 x 1.5	ER25
	-ES16	10.112.272	M22 x 1.5	ER16

FIXED TOOL HOLDER

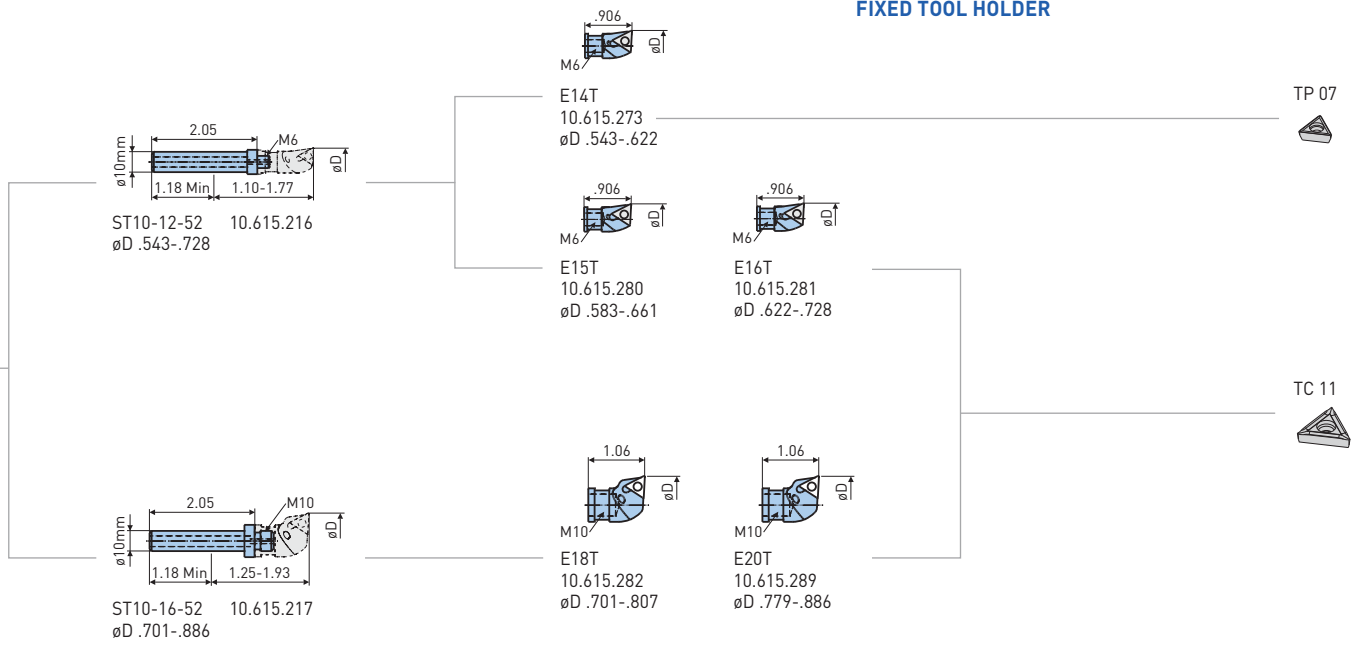

EWN 04-15E FINE BORING HEAD

RANGE: ϕ .016"-.590"

Fine boring heads for the machining of smallest bores with highest spindle speeds on small machine tools. The boring heads are available with both modular CK3 connection and cylindrical shanks ϕ 16mm.



Catalog Number	Reference Number
EWN04-15ECK3	10.112.515

OTHER EXECUTIONS

EWN04-15EST16
10.112.516



BORING HEAD CATALOG NUMBER

REFERENCE NUMBER

EWN04-15ECK3 10.112.515

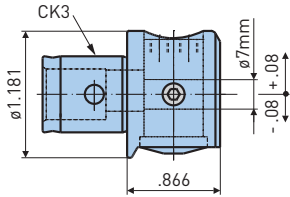

EWN04-15EST16 10.112.516

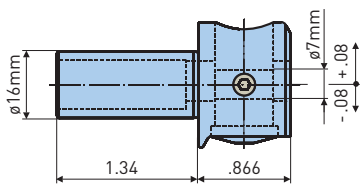

Boring Cutter	Catalog Number	Reference Number	X	Grade	ϕ D
	E0.4-ST7-52K10C	10.615.522	.098	C3 Coated Carbide AICRN	.016-.039
	E0.9-ST7-52K10C	10.615.524	.157		.035-.059
	E1.4-ST7-52K10C	10.615.525	.236		.055-.079
	E2-ST7-52K10C	10.615.501	.275		.075-.118
	E3-ST7-52K10C	10.615.502	.394		.114-.157
	E4-ST7-52K10C	10.615.503	.512		.154-.197
	E5-ST7-52K10C	10.615.504	.630	WC02	.193-.236
	E6-ST7-WC02-52HM	10.615.505	.787		.228-.276
	E7-ST7-WC02-52HM	10.615.506		1.181	TP07
	E8-ST7-TP07-52HM	10.615.507	.307-.354		
	E9-ST7-TP07-52HM	10.615.508	.346-.394		
	E10-ST7-TP07-52HM	10.615.509	.386-.472		
	E12-ST7-TP07-52HM	10.615.511	.465-.590		

ACCESSORIES

<p>SPARE PARTS PG. 444</p>	<p>INSERTS PG. 506</p>	<p>APPLICATION ADVICE PG. 447</p>
--------------------------------	----------------------------	---

OD TURNING

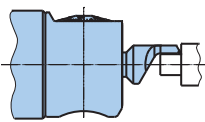

OD Turning Cutter	Catalog Number	Reference Number	X	Grade	ϕ D
	OD-0-3-ST7-52K10C	10.615.530	.098	C3 Coated Carbide AICrN	.008-.118
	OD-2-6-ST7-52K10C	10.615.531	.236		.079-.236

EWN 04-7E Fine Boring Head

RANGE: $\phi.016$ " - $.276$ " World's smallest fine boring head: Thanks to its body diameter of only $\phi.728$ ", the EWN 04-7E is the perfect solution for micro machining applications.



OTHER EXECUTIONS



Catalog Number	Reference Number
EWN04-7ECK1	10.112.513

BORING HEAD CATALOG NUMBER

REFERENCE NUMBER

EWN04-7ECK1

10.112.513

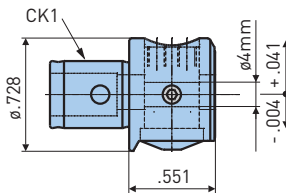

EWN04-7EST10

10.112.514

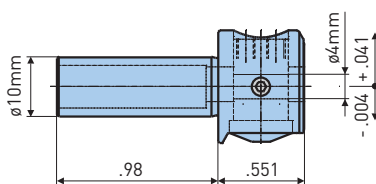

EWN04-7EST6

10.112.518

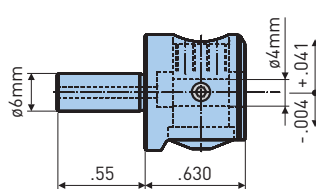

- The boring cutters are made with flat for cutting edge orientation.
- Other lengths and geometries available upon request.

Boring Cutter	Catalog Number	Reference Number	L	X	R	Grade	ϕD			
	E0.4-ST4-30K10C	10.615.541	1.181	.060	.002	C3 Coated Carbide AICRN	.016-.035			
	E0.9-ST4-30K10C	10.615.542		.120			.035-.055			
	E1.4-ST4-30K10C	10.615.543		.197			.055-.078			
	E2-ST4-30K10C	10.615.544		.236			.075-.118			
	E3-ST4-30K10C	10.615.545		.394			.114-.157			
	E4-ST4-30K10C	10.615.546		.512			.154-.197			
	E5-ST4-30K10C	10.615.547		.630			.193-.275			
	E0.4-ST4-25K10C	10.615.561		.984			.043	.004	C3 Coated Carbide AICRN	.016-.024
	E0.6-ST4-25K10C	10.615.562					.059			.024-.031
	E0.8-ST4-25K10C	10.615.563					.079			.031-.047
E1.2-ST4-25K10C	10.615.564	.098	.047-.059							
E1.5-ST4-25K10C	10.615.565	.138	.059-.075							
E1.9-ST4-25K10C	10.615.566	.177	.075-.118							
E0.4-ST4-25K10	10.615.551	.984	.043		.004	C3 Uncoated Carbide	.016-.024			
E0.6-ST4-25K10	10.615.552		.059				.024-.031			
E0.8-ST4-25K10	10.615.553		.079				.031-.047			
E1.2-ST4-25K10	10.615.554		.098				.047-.059			
E1.5-ST4-25K10	10.615.555		.138	.059-.075						
E1.4-ST4-24CBN20	10.615.571		1.071	.138			.004	CBN-20	.055-.078	
E1.9-ST4-24CBN20	10.615.572	.177		.075-.118						
E2.9-ST4-27CBN20	10.615.573	.315		.114-.157						
E3.9-ST4-30CBN20	10.615.574	.433		.154-.197						
E4.9-ST4-30CBN20	10.615.575	.630		.193-.236						

OD TURNING

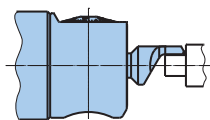

OD Turning Cutter	Catalog Number	Reference Number	L	X	Grade	ϕD
	OD-0.2-2.3-ST4-25K10C	10.615.590	.984	.087	C3 Coated Carbide AICrN	.008-.091

SERIES 112 SPARE PARTS

SERVICE INSTRUCTIONS FOR 112 HEADS

- Clean CK adapters prior to assembly
- Check cutting edge for wear prior to use
- All moving parts must be lubricated monthly using a light machine oil such as Mobil Vactra No. 2, BP Energol HLP-32, or Klueber Isoflex PDP94

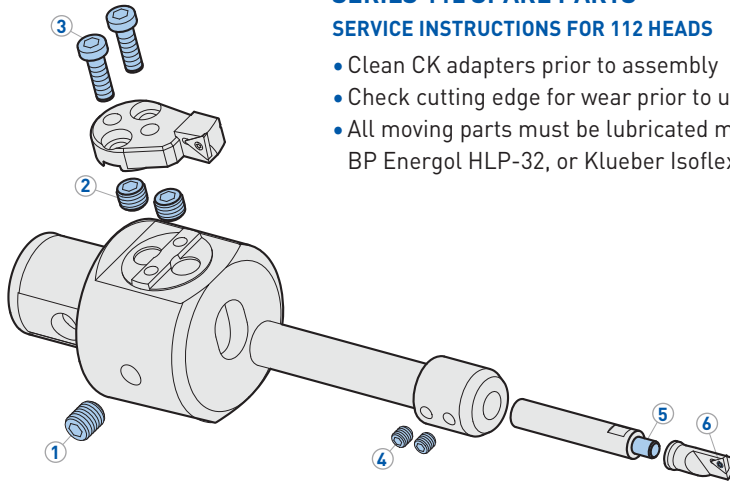

BORING HEADS—EWN

Catalog Number	Locking Screw (1)	Torque (ft-lbs)	Bar Locking Screw (2)	Torque (ft-lbs)	Mounting Screw (3)	Torque (ft-lbs)
EWN 2-50XL	10.690.452	7.5	10.690.595	7.5	10.690.156	9
EWB 2-50	10.690.452	7.5	10.690.595	7.5	—	—
EWN/EWB 2-32	10.690.449	3.8	10.690.460	3.8		
EWN 04-22	10.690.489	1.8	10.690.421	1.8		
EWN 04-15	10.690.418	1.0	10.690.440	1.0		
EWN 04-7	10.690.978	.6	10.690.538	.6		

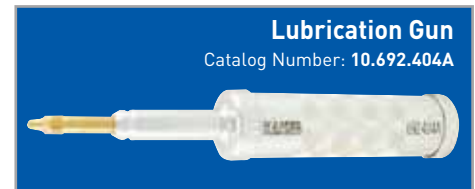

REDUCTION BUSHINGS

ød	Reduction Set Screw (4)	Torque (ft-lbs)
3.5mm	10.690.459	.4
4mm		
4.5mm		
5mm		
6mm	10.690.489	1.8
7mm		
8mm		
9mm		
10mm		

BAR, EXTENSIONS & REDUCTIONS

ød	Component	Thread	Boring Bar Screw
8mm	10.615.211	M5	10.690.486
	10.615.212		
	10.615.222		
10mm	10.615.214	M6	10.690.487A
	10.615.215		
	10.615.223		
11mm	10.615.250	M6	10.690.487A
12mm	10.615.218	M6	10.690.487A
	10.615.219		
	10.615.224		
	10.615.225		
13mm	10.615.251	M6	10.690.487A
14mm	10.615.232	M6	10.690.487A
5/8"	10.615.236	M10	10.690.488
16mm	10.615.226	M10	10.690.488
10mm-12mm	10.615.216	M6	10.690.487A
10mm-16mm	10.615.217	M6	10.690.487A
12mm-16mm	10.615.239	M10	10.690.488
12mm-16mm	10.615.240	M10	10.690.488
12mm-16mm	10.615.243	M10	10.690.488
12mm	10.615.220	M6	10.690.487A
16mm-10mm	10.615.230	M6	10.690.487A
16mm-10mm	10.615.231	M6	10.690.487A

INSERT SCREWS

Insert Type	Insert Screw (6)	Wrench
WC..02	10.694.101	10.694.806
TP..07	10.694.103*	10.694.806
TC..11	10.694.122	10.694.807
CC..06	10.694.122	10.694.807
CC..09	10.694.141	10.694.815

*For boring bars 10.615.205/207/507 use insert screw 10.694.102

BORING HEADS—EWD & EWE

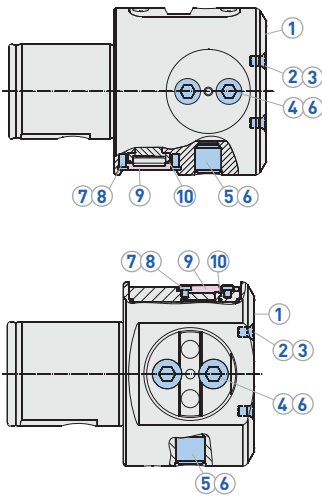

Head Type					Torque (ft.-lbs.)		Torque (ft.-lbs.)
	(1)	Screw (2)	Wrench (3)	Screw (4)		Screw (5)	
EWD 2-54E	10.195.081*	10.690.981*	10.690.843	10.690.457	7.4	10.690.469*	7.4
	10.195.127**	10.690.614**				10.690.995**	
EWD 2-32E	10.112.371	10.690.611	10.690.836	10.690.460	3.7	10.690.996	3.7
EWE 2-152E	10.112.804	10.690.614	10.690.843	10.690.457	7.4	10.690.995	7.4
EWE 2-32E	10.112.371	10.690.611	10.690.836	10.690.460	3.7	10.690.996	3.7

Head Type			Torque (ft.-lbs.)			
	Wrench (6)	Screw (7)		Battery (9)	O-Ring (10)	Wrench (8)
EWD 2-54E	10.690.816	10.690.320*	3.0	10.112.080*	10.692.296*	10.690.843
		10.690.994**	.7	10.310.905**	10.692.381*	10.694.808
EWD 2-32E	10.690.814	10.690.994	.7	10.310.905	10.692.381	10.694.808
EWE 2-152E	10.690.816	10.690.326	.7	10.395.170	10.395.161	10.694.808
EWE 2-32E	10.690.814	10.690.326	.7	10.395.170	10.395.161	10.694.808

*Spare parts for boring heads with Order No. 112.109A
 **Spare parts for boring heads with Order No. 112.109B

ADJUSTABLE TOOL HOLDER

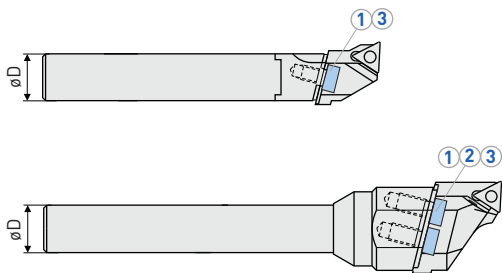

øD	Type			Torque (ft.-lbs.)	
		Screw (1)	Washer (2)		Wrench (3)
9mm	10.615.369	10.690.323	—	.7	10.690.837
	10.615.374	10.690.323	—	.7	10.690.837
11mm	10.615.371	10.690.324	—	1.5	10.690.838
	10.615.375	10.690.324	—	1.5	10.690.838
13mm	10.615.373	10.690.183	—	3.0	10.690.803
	10.615.377	10.690.183	—	3.0	10.690.803
5/8"	10.615.254	10.690.113	—	7.4	10.690.804
	10.615.255	10.690.113	—	7.4	10.690.804
16mm	10.615.252	10.690.113	—	7.4	10.690.804
	10.615.253	10.690.113	—	7.4	10.690.804
5/8"	10.615.259	10.690.150	10.615.904	12.5	10.690.805
	10.615.260	10.690.150	10.615.904	12.5	10.690.805
16mm	10.615.257	10.690.150	10.615.904	12.5	10.690.805
	10.615.258	10.690.150	10.615.904	12.5	10.690.805

SETTING JIG

The setting jig can be easily assembled on the front face of the boring heads EWN/EWB 2-50.

Set the measuring slide to the required projection length. Pull the tool holder until the cutting edge touches the lower end of the measuring slide. Align the cutting edge with the edge of the measuring slide.

The scale on the measuring slide provides a coarse diameter setting.

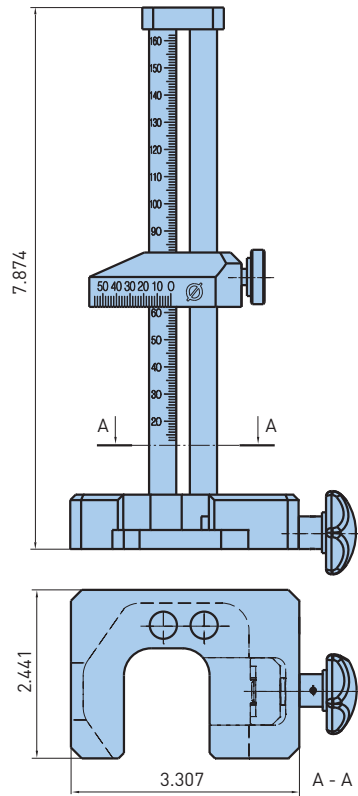

Catalog Number	Description
10.112.817	Setting Jig EWN2-50
10.112.819	Setting Jig EWN2-50 Inch

SERIES 112—INSERT SELECTION & CUTTING DATA

BORING RANGE: ø.228"-.650"



OPTIMAL CONDITIONS:

- Length to diameter ratio less than 4:1
- Rigid fixture and workpiece
- Good machine spindle

CRITICAL CONDITIONS:

- Length to diameter ratio over 4:1
- Unstable fixture and/or workpiece
- Worn machine spindle/poor runout

Material	Insert Radius	Stock Allow "/Dia.	Inserts & Cutting Speeds						Feed (IPR)
			Optimal Conditions			Critical Conditions			
			WC..02	TP..07	Speed [SFM]	WC..02	TP..07	Speed [SFM]	
Mild, Low-Carbon Steels 10xx-15xx 1018,1020, 1551, A36	.004	.004-.008	10.655.604	10.651.824	500-800	10.655.604	10.651.824	300-450	.0015-.0020
	.008	.008-.012	10.655.600	10.651.802		10.655.601	10.651.835		.0020-.0030
	.016	.012-.016	11.655.606	10.651.702		—	10.651.736		.0025-.0030
High Carbon Alloy Steels 23xx-92xx, Tool Steel 4140, 4340, 8620	.004	.004-.008	10.655.604	10.651.824	400-650	10.655.604	10.651.824	250-400	.0015-.0020
	.008	.008-.012	10.655.600	10.651.802		10.655.601	10.651.835		.0020-.0030
	.016	.012-.016	11.655.606	10.651.702		—	10.651.736		.0025-.0030
300 Stainless Steels Austenitic 303, 304, 316, 17-4ph	.004	.004-.008	10.655.606	—	250-500	10.655.606	—	200-300	.0010-.0015
	.008	.008-.012	10.655.602	10.651.839		10.655.602	10.651.837		.0015-.0020
	.012	.012-.016	—	10.651.737		—	10.651.737		.0020-.0250
400 Stainless Steels Martensitic 403, 410, 416, 430	.004	.004-.008	10.655.604	10.651.824	500-750	10.655.606	—	250-400	.0015-.0020
	.008	.008-.012	10.655.600	10.651.802		10.655.602	10.651.837		.0020-.0030
	.016	.012-.016	11.655.606	10.651.702		—	10.651.737		.0025-.0030
Grey Cast Iron Malleable Class 20, 30	.004	.004-.008	10.655.605	10.651.824	500-750	10.655.605	10.651.824	300-450	.0015-.0020
	.008	.008-.012	10.655.603	—		10.655.603	10.651.833		.0020-.0030
	.012	.012-.016	—	10.651.735		—	10.651.735		.0025-.0030
CBN-CH, CBN-CHN	—	.008-.012	11.938.863	11.938.872	750-1000	—	—	—	.0020-.0030
Cast Iron Ductile/Nodular/Chilled	.004	.004-.008	10.655.605	10.651.824	375-650	10.655.605	10.651.824	250-400	.0015-.0020
	.008	.008-.012	11.655.607	—		10.655.603	—		.0020-.0030
	.012	.012-.016	—	10.651.632		—	10.651.632		.0025-.0030
High Temp. Alloys Titanium, Inconel, Monel	.004	.003-.006	10.655.606	—	200-325	10.655.606	—	150-225	.0010-.0015
	.008	.006-.010	10.655.602	10.651.837		10.655.602	10.651.837		.0010-.0020
	.012	.008-.012	—	10.651.737		—	10.651.737		.0015-.0025
Copper Alloys Brass, Bronze	.004	.004-.008	—	—	600-1000	—	—	350-500	.0015
	.008	.008-.012	11.655.607	—		10.655.605	—		.0020
	.012	.012-.016	—	10.651.623		—	10.651.623		.0030
Aluminum/Magnesium 6061, 7075 Carbide Inserts	.004	.004-.008	10.655.605	10.651.823	600-1000	10.655.605	10.651.823	350-600	.0015-.0025
	.008	.008-.012	10.655.603	10.651.825		10.655.603	10.651.825		.0020-.0030
	.012	.012-.016	—	10.651.723		—	10.651.723		.0030-.0040
	.016	.016-.020	—	10.651.725		—	10.651.725		.0035-.0045
Aluminum/Magnesium 6061, 7075 PCD Inserts	.008	.010-.014	11.938.845	—	800-1350	—	—	—	.0020-.0030
	.012	.016-.020	—	10.938.840		—	—		.0030-.0040
Tool Steel (Min 50 Rc) CBN Inserts	.008	.004-.008	11.938.846	—	150-225	—	—	—	.0008-.0012
	.012	.004-.008	—	10.938.837		—	—		.0010-.0015

All Cutting Data Without Guarantee

$$\text{RPM} = \frac{\text{SFM} \times 3.82}{\text{Bore } \phi}$$

$$\text{IPM} = \text{RPM} \times \text{IPR}$$

SERIES 112—INSERT SELECTION & CUTTING DATA

BORING RANGE: ø.583"-2.125"



OPTIMAL CONDITIONS:

- Length to diameter ratio less than 4:1
- Rigid fixture and workpiece
- Good machine spindle

CRITICAL CONDITIONS:

- Length to diameter ratio over 4:1
- Unstable fixture and/or workpiece
- Worn machine spindle/poor runout

Material	Insert Radius	Stock Allow "/Dia.	Inserts & Cutting Speeds								Feed (IPR)
			Optimal Conditions				Critical Conditions				
			TC..11	CC..06	CC..09	Speed (SFM)	TC..11	CC..06	CC..09	Speed (SFM)	
Mild, Low-Carbon Steels 10xx-15xx 1018,1020, 1551, A36	.008	.008-.012	11.656.352	11.654.856	—	1000-1450	10.655.372	11.654.840	—	525-675	.0015-.0025
	.016	.016-.020	11.655.322	11.654.865	11.654.959		10.655.381	11.654.850	11.654.940		.0030-.0040
	.031	.024-.040	11.655.332	11.654.867	11.654.960		—	—	—		.0050-.0060
High Carbon Alloy Steels 23xx-92xx, Tool Steel 4140, 4340, 8620	.008	.008-.012	11.656.352	11.654.856	—	800-1100	10.655.372	11.654.840	—	400-550	.0015-.0025
	.016	.016-.020	11.655.322	11.654.865	11.654.959		10.655.381	11.654.850	11.654.940		.0030-.0040
	.031	.024-.040	11.655.332	11.654.867	11.654.960		—	—	—		.0050-.0060
300 Stainless Steels Austenitic 303, 304, 316, 17-4ph	.008	.008-.012	10.655.379	11.654.856	—	550-800	10.655.379	—	—	350-525	.0015-.0025
	.016	.016-.020	10.655.389	11.654.865	11.654.959		10.655.389	11.654.845	11.654.968		.0030-.0040
	.031	.024-.040	10.655.399	11.654.867	11.654.960		—	—	—		.0050-.0060
400 Stainless Steels Martensitic 403, 410, 416, 430	.008	.008-.012	11.656.352	11.654.856	—	650-875	10.655.379	—	—	425-550	.0015-.0025
	.016	.016-.020	11.655.322	11.654.865	11.654.959		10.655.389	11.654.845	11.654.968		.0030-.0040
	.031	.024-.040	11.655.332	11.654.867	11.654.960		—	—	—		.0050-.0060
Grey Cast Iron Malleable Class 20, 30	.008	.008-.012	10.655.373	11.654.840	—	650-1000	10.655.373	—	—	350-500	.0015-.0025
	.016	.016-.020	10.655.383	11.654.850	11.654.940		10.655.383	11.654.868	11.654.968		.0030-.0040
	.031	.024-.050	10.655.393	11.654.860	11.654.952		—	—	—		.0050-.0060
CBN-CH, CBN-CHN	—	.016-.030	11.938.833	11.938.835	11.938.838	1500-2000	—	—	—	—	.0020-.0030
Cast Iron Ductile/Nodular/Chilled	.008	.008-.012	10.655.301	11.654.840	—	375-625	10.655.373	—	—	250-350	.0015-.0025
	.016	.016-.020	10.655.302	11.654.850	11.654.940		10.655.383	11.654.868	11.654.968		.0030-.0040
	.031	.024-.040	10.655.303	11.654.860	11.654.952		—	—	—		.0050-.0060
High Temp. Alloys Titanium, Inconel, Monel	.008	.008-.012	10.655.379	—	—	200-325	10.655.379	—	—	125-250	.0010-.0020
	.016	.016-.020	10.655.389	11.654.868	11.654.968		10.655.389	11.654.963	11.654.957		.0020-.0030
	.031	.024-.040	10.655.399	—	11.654.969		—	—	—		.0030-.0040
Copper Alloys Brass, Bronze	.008	.008-.012	11.655.315	—	—	1100-1800	11.655.315	—	—	400-700	.0015-.0025
	.016	.016-.020	11.655.325	11.654.858	11.654.957		11.655.325	11.654.858	11.654.957		.0030-.0040
	.031	.024-.040	11.655.335	11.654.864	11.654.958		—	—	—		.0050-.0060
Aluminum/Magnesium 6061, 7075 Carbide Inserts	.008	.008-.012	10.655.378	10.654.877	—	1200-1600	10.655.378	10.654.877	—	600-1100	.0015-.0025
	.016	.016-.020	10.655.388	10.654.888	10.654.977		10.655.388	10.654.888	11.654.977		.0030-.0040
	.031	.024-.040	10.655.398	10.654.898	10.654.987		—	—	—		.0050-.0060
Aluminum/Magnesium 6061, 7075 PCD Inserts	.008	.016-.020	11.938.861	11.938.847	—	2000-4000	—	—	—	—	.0015-.0025
	.016	.016-.020	10.938.841	11.938.842	11.938.843		—	—	—		.0030-.0040
	.031	.024-.050	11.938.860	—	11.938.851		—	—	—		.0050-.0060
Tool Steel (Min 50 Rc) CBN Inserts	.016	.016-.020	10.938.834	11.938.835	11.938.838	200-300	—	—	—	—	.0015-.0020
	.031	.024-.040	10.938.865	—	—	—	—	—	—	.0020-.0025	

All Cutting Data Without Guarantee

$$\text{Cutting Speed: } \text{RPM} = \frac{\text{SFM} \times 3.82}{\text{Bore } \phi}$$

$$\text{Feed Rate: } \text{IPM} = \text{RPM} \times \text{IPR}$$

SERIES 112 EWN 2-50XL —INSERT SELECTION & CUTTING DATA

BORING RANGE: ø3.150"-6.000"



Material	Insert Radius	Inserts & Cutting Speeds			
		Inserts	Stock Allowance/Dia.	Speed (SFM)	Feed (IPR)
Mild, Low-Carbon Steels 10xx-15xx 1018, 1020, 1551, A36	.008	11.656.352	.008-.012	450-800	.0020
	.016	11.655.322	.016-.020		.0040
	.031	11.655.332	.024-.040		.0060
High Carbon Alloy Steels 23xx-92xx, Tool Steel 4140, 4340, 8620	.008	11.656.352	.008-.012	400-700	.0020
	.016	11.655.322	.016-.020		.0040
	.031	11.655.332	.024-.040		.0060
300 Stainless Steels Austenitic 303, 304, 316, 17-4ph	.008	10.655.379	.008-.012	350-550	.0020
	.016	10.655.389	.016-.020		.0040
	.031	10.655.399	.024-.040		.0060
400 Stainless Steels Martensitic 403, 410, 416, 430	.008	11.656.352	.008-.012	400-650	.0020
	.016	11.655.322	.016-.020		.0040
	.031	11.655.332	.024-.040		.0060
Grey Cast Iron Malleable Class 20, 30	.008	10.655.373	.008-.012	450-750	.0020
	.016	10.655.383	.016-.020		.0040
	.031	10.655.393	.024-.050		.0060
Cast Iron Ductile/Nodular/Chilled	.008	10.655.301	.008-.012	300-550	.0020
	.016	10.655.302	.016-.020		.0040
	.031	10.655.303	.024-.040		.0060
High Temp. Alloys Titanium, Inconel, Monel	.008	10.655.379	.008-.012	150-300	.0015
	.016	10.655.389	.016-.020		.0020
	.031	10.655.399	.024-.040		.0030
Copper Alloys Brass, Bronze	.008	11.655.315	.008-.012	550-800	.0020
	.016	11.655.325	.016-.020		.0040
	.031	11.655.335	.024-.040		.0060
Aluminum/Magnesium 6061, 7075 Carbide Inserts	.008	10.655.378	.008-.012	650-1000	.0020
	.016	10.655.388	.016-.020		.0040
	.031	10.655.398	.024-.040		.0060
Tool Steel (Min 50 Rc) CBN Inserts	.016	10.938.834	.016-.020	200-300	.0015
	.031	10.938.865	.024-.040		.0020

All Cutting Data Without Guarantee

Cutting Speed:

$$RPM = \frac{SFM \times 3.82}{\text{Bore } \phi}$$

Feed Rate:

$$IPM = RPM \times IPR$$

FINE BORING GUIDELINES

Major Influences of Fine Boring

- The amount of stock to be removed (D.O.C.)
- Feed rate
- Cutting speed

For all of these influences, a balance must be obtained for optimal machining. Too much stock or too heavy of a feed rate will generate excessive cutting forces that can result in inconsistent bore size. When stock or feed rates are too light, the possibility of chatter increases due to deflection.

D.O.C

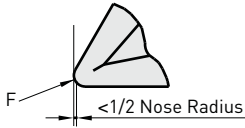

High Possibility for Deflection & Chatter:

When D.O.C. is less than half the insert nose radius, the resulting forces (F) are almost 100% radial.

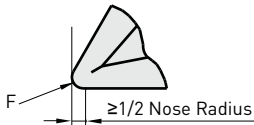

Good Stable Cut:

When D.O.C. is greater than or equal to half the insert nose radius, the resulting forces (F) are almost 100% axial.

FEED RATE

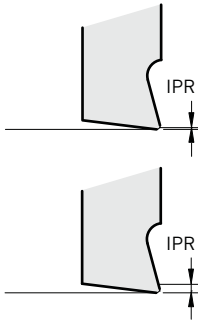

High Possibility for Deflection & Chatter:

When the feed rate is less than the hone on the insert tip, the risk of vibration increases.

Good Stable Cut:

When the feed rate is larger than the hone on the insert tip, full use of the chip breaker is allowed. This results in lower cutting forces.

CUTTING SPEED

Higher Speeds:

- Better surface finish
- Shorter machining times
- Better chip evacuation

As a general rule, the tool's length/diameter ratio and insert radius will determine optimum cutting speed.

*For smaller diameter bores, carbide or heavy metal bars may be required to eliminate vibration & chatter

Lower Speeds:

- Poorer surface finish
- Low chance for chatter
- Longer machining times
- High chance for built-up edge, results in shorter insert life

L/D Ratio	Max Insert Radius	Speed Reduction
≤4:1	.031	100% of optimum
≤5:1	.016	75% of optimum
≤6:1	.008	60% of optimum
≥7:1	.008	50% of optimum

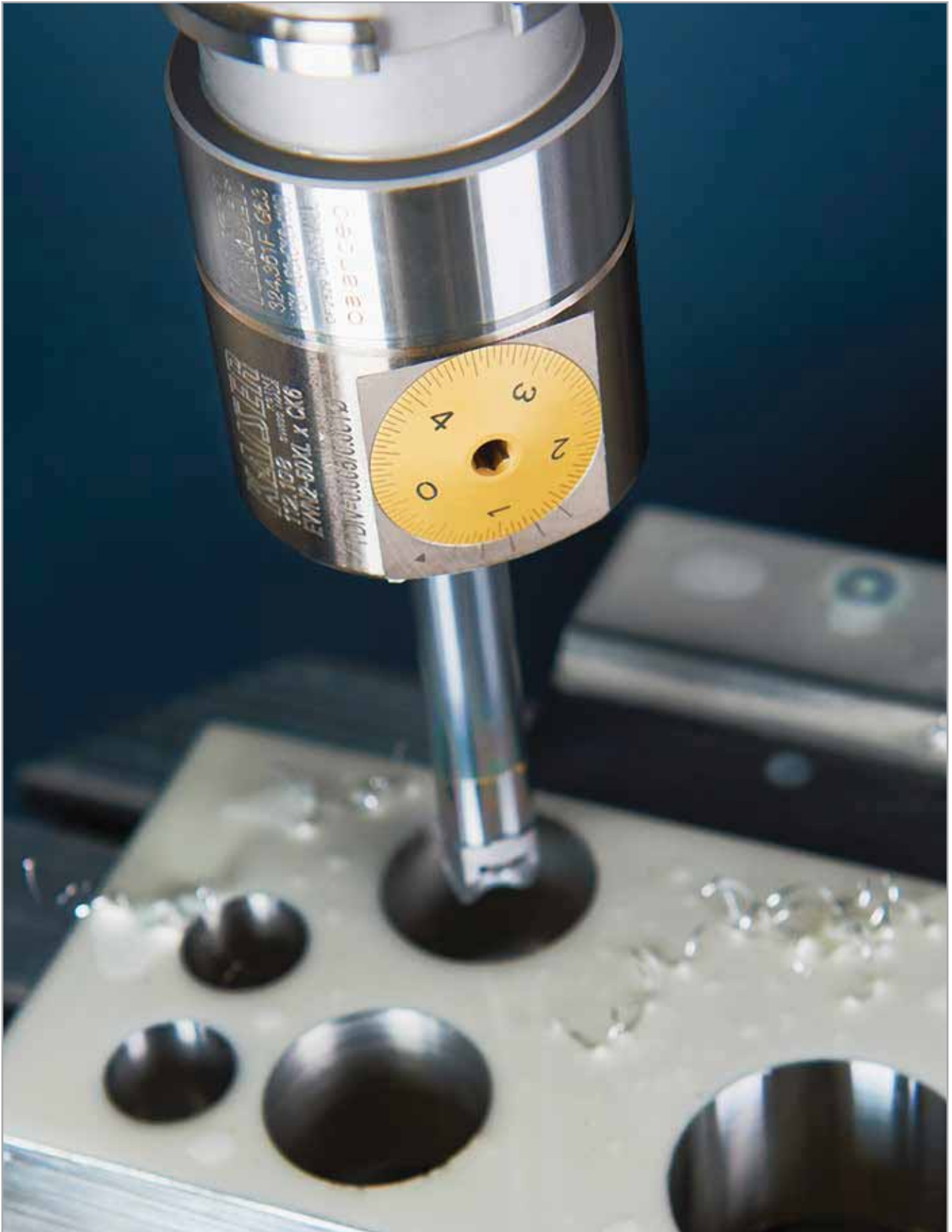

PERIPHERAL CUTTING EDGE

FINE BORING

B.3



FINE BORING **B.3**

FINE BORING HEADS
454-475

OVERVIEW	454
EWE DIGITAL FINE BORING HEADS	455
EWN FINE BORING HEADS	456
EWN BIG CAPTO FINE BORING HEADS	457
SMART DAMPER BORING	458-459
SERIES 310 INSERT HOLDERS	460-463
OD TURNING FOR EWN/EWE	464
SERIES 309 EWB-UP	465
EWB BALANCED FINE BORING HEADS	466-467
CKB BORING BAR	468
HYDRAULIC CHUCKS CLAMPING SYSTEM	469
STRAIGHT COLLET	469
EW FINE BORING HEAD	470
TROUBLESHOOTING	471
INSERT SELECTION & CUTTING DATA	472-473
SPARE PARTS	474-475

EWE DIGITAL



Wireless communication for easy readout with the BIG KAISER app: The brandnew EWE fine boring heads revolutionate fine boring.
 ø1.614"-7.992"
 CKB1-CKB6

PG. 455

EWD SMART DAMPER DIGITAL



The combination of the most advanced technologies to a powerful and highly productive tool: an integral digital fine boring head with an innovative and patented damping technology.
 ø1.614"-5.906"
 CKB4-CKB6

PG. 458

EWN



The EWN single cutter boring tool program for fine boring covers a range of ø20-203mm with only 7 precision boring heads. Due to the optimized balance over the whole adjustment range, cutting speeds up to 1200 m/min are permitted.
 ø1.614"-7.992"
 CKB1-CKB7/BIG CAPTO C3-C8

PG. 456

EWB BALANCED



Even at max. speeds the balanced EWB fine boring heads guarantee vibration-free boring, resulting in increased productivity and highest precision.
 ø1.260"-4.134"
 CK3-CK6

PG. 466

EWB-AL BALANCED



The fine boring heads EWB AL are made of high strength aluminium with hard coating. Together with reductions and extensions made in the same way, the weight for long and large diameter tool combinations is reduced by more than 50%.
 ø3.937"-7.992"
 CK6-CK7

PG. 467

EWB-UP BALANCEABLE



The ultra-precision EWB-UP series sets higher standards for boring heads concerning adjustment accuracy and balance quality.
 ø.984"-3.937"
 CK2-CK6

PG. 465

EW



These heads are designed to be used in combination with the steel or carbide-boring bars ø14mm and ø16mm out of the accessory program. In conjunction with the long carbide bar, the tool is well suited for vibration-free finishing operations in bores with unfavorable Ø/L-ratios.
 ø.591"-.866"
 ES15/ES18

PG. 470

EWE DIGITAL FINE BORING HEADS

RANGE: $\phi 1.614''$ - $8.000''$ ($\phi 41$ - 203 mm)

Thanks to wireless communication with the BIG KAISER app, manufacturing precise bores has become very easy.

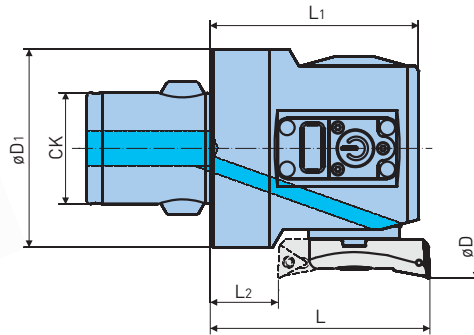

Catalog Number	Reference Number	CK	Front Boring ϕD	Back Boring ϕD	ϕD_1	L	L1	L2	Weight (lbs.)
EWE41-74E-CKB4	10.310.845	CKB4	1.614-2.913	2.087-2.913	1.496	1.850	1.693	.551	.7
EWE53-95E-CKB5	10.310.855	CKB5	2.087-3.740	2.441-3.740	1.929	2.244	2.087	.748	1.7
EWE68-150E-CKB6	10.310.861	CKB6	2.677-5.906	3.150-5.906	2.520	2.795	2.646	.866	3.7
EWE100-203E-CKB6	10.310.866		3.937-8.000	4.409-8.000	3.543	2.795	2.646	.866	5.5
-203E-CKB7	10.310.875	CKB7	3.937-8.000	4.409-8.000	3.543	3.425	3.276	1.496	8.8

- *Max body diameter: 90 mm
- Insert holder is to be ordered separately

ACCESSORIES

<p>SPARE PARTS PG. 474</p>	<p>INSERTS PG. 506</p>	<p>APPLICATION ADVICE PG. 472</p>
---------------------------------------	-----------------------------------	--

BIG KAISER APP

Enhances user friendliness while assembling and running our boring tools. The app helps operators to determine optimal cutting parameters, manuals and provides a history of all adjustments made with an EWE boring head.

Ways the App Will Support Your Daily Challenges

- Choose your tool
- Type in your application values
- Calculate cutting data
- Adjust machine and make a measuring bore
- Infeed tool with the diameter of the measuring bore
- Make the bore

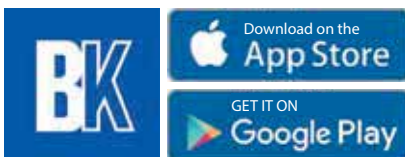

EWN FINE BORING HEADS

RANGE: ϕ .787"-8.000" (ϕ 20-203mm)

The EWN single cutter boring tool program for fine boring covers a range of ϕ .787"-8.000" with only 7 fine boring heads. Due to the optimized balance over the whole adjustment range, cutting speeds up to 1200 m/min are permitted.

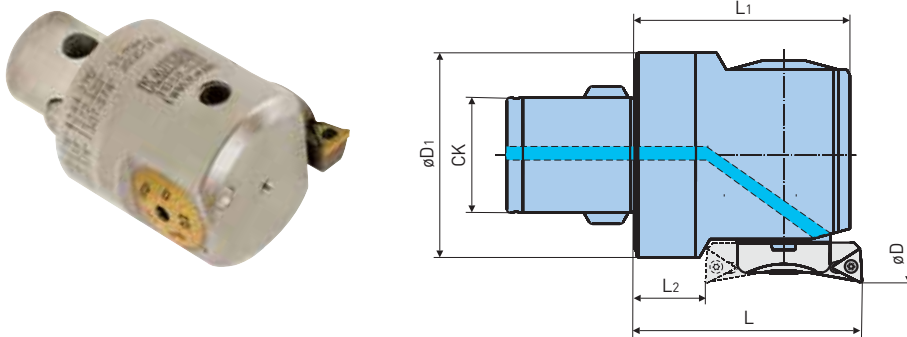

Catalog Number	Reference Number	CK	Front Boring ϕD^*	Back Boring ϕD	ϕD_1	L	L1	L2	Weight (lbs.)
EWN20-36E-CKB1	10.310.111	CKB1	.787-1.417	1.102-1.417	.728	1.280	1.161	.413	.2
EWN25-47E-CKB2	10.310.211	CKB2	.984-1.850	1.417-1.850	.921	1.398	1.280	.453	.3
EWN32-60E-CKB3	10.310.311	CKB3	1.260-2.362	1.811-2.362	1.181	1.575	1.378	.394	.5
EWN41-74E-CKB4	10.310.411	CKB4	1.614-2.913	2.087-2.913	1.496	1.850	1.693	.551	.9
EWN53-95E-CKB5	10.310.511	CKB5	2.087-3.740	2.441-3.740	1.929	2.244	2.087	.748	1.8
EWN68-150E-CKB6	10.310.611	CKB6	2.677-5.906	3.150-5.906	2.520	2.795	2.646	.866	3.7
EWN100-203E-CKB6	10.310.612		3.937-8.000	4.409-8.000	3.543	2.795	2.646	.866	5.3
-203E-CKB7-87	10.310.711	CKB7	3.937-8.000	4.409-8.000	3.543	3.425	3.276	1.496	8.6
-203E-CKB7-117	10.310.718		3.937-8.000	4.409-8.000	3.543	4.606	4.457	2.677	11.9

*Front Boring ϕD depends on insert holder
 • Insert holders sold separately, see page 462

ACCESSORIES

 SPARE PARTS PG. 474	 INSERTS PG. 506	APPLICATION ADVICE PG. 472
-----------------------------------	-------------------------------	--

EWN BIG CAPTO FINE BORING HEADS

RANGE: $\phi 1.260''$ - $8.000''$ ($\phi 32$ - 203mm)

With only 5 fine boring heads, the diameter range from $\phi 1.260''$ - $8.000''$ is completely covered. The boring heads can be clamped in BIG CAPTO shanks and other polygonal basic holders, or directly in BIG CAPTO machine spindles.

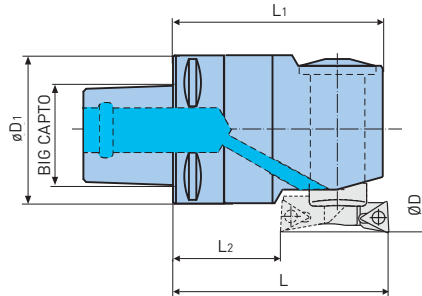

Catalog Number	Reference Number	CK	Front Boring ϕD	Back Boring ϕD	$\phi D1$	L	L1	L2	Weight (lbs.)
EWN32-60E-C3	10.470.311	C3	1.260-2.362	1.811-2.362	1.260	2.165	1.969	.984	.7
EWN41-74E-C4	10.470.411	C4	1.614-2.913	2.087-2.913	1.575	2.638	2.480	1.339	1.3
EWN53-95E-C5	10.470.511	C5	2.087-3.740	2.441-3.740	1.969	3.031	2.874	1.535	2.4
EWN68-150E-C6	10.470.611	C6	2.677-5.906	3.150-5.906	2.520	3.622	3.465	1.693	4.8
EWN100-203E-C6	10.470.612	C6	3.937-8.000	4.409-8.000	3.543	3.622	3.465	1.693	6.4

ACCESSORIES

<p>SPARE PARTS PG. 474</p>	<p>INSERTS PG. 506</p>	<p>APPLICATION ADVICE PG. 472</p>
--------------------------------	----------------------------	---



SMART DAMPER BORING

BORING RANGE: $\phi 1.614''$ - $5.906''$ ($\phi 41$ - 150 mm)

Integrated Damping System in EWN/EWD Finishing Boring Head



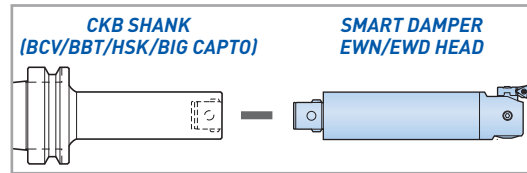

The integrated design of the Smart Damper system and EWN/EWD finish boring head shortens the distance from the damper and the cutting edge which is the source of vibration, so higher damping effects minimizes the chatter or vibration.

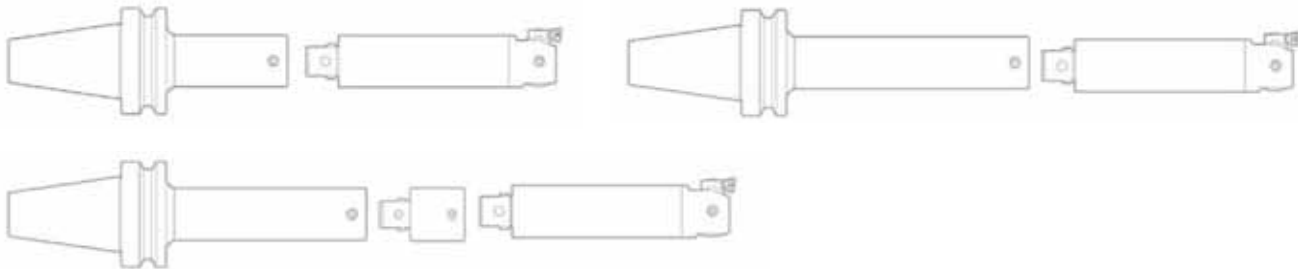

Tool Configuration Can be Arranged Optimally by Assembling with Numerous Standard Shanks

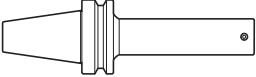

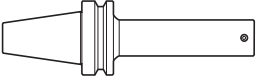
Finish Boring of Ductile Nodular Cast Iron

Tool Layout	Total Length	L/D	Cutting Speed (SFM)						
			330	500	650	825	1000	1150	1300
CK SHANK BBT50-CKB4-178 +  SMART DAMPER EWN HEAD EWN41DP 	14.29	7.8	⊙	⊙	⊙	⊙	⊙	⊙	⊙
CK SHANK BBT50-CKB4-178 +  EXTENSION CKB44-45 +  SMART DAMPER EWN HEAD EWN41DP 	16.06	8.9	⊙	⊙	⊙	⊙	⊙	⊙	⊙

Cutting Conditions

Vertical Machining Center
 Depth of Cut: $.008''/\phi$
 Feed Rate: $.004''/\text{rev.}$

Workpiece Material: High Carbon Steel
 Insert: TCMT110204EFM (T2000Z)
 Diameter: $\phi 1.750''$

⊙ = Acceptable ⊙ = Excellent Surface Finish

SMART DAMPER BORING EWN Finishing Head—Dial Readout

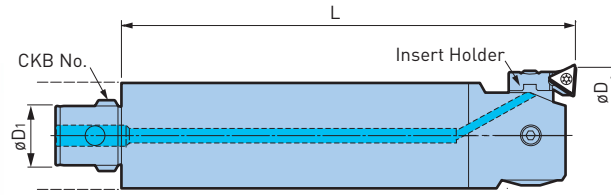

Catalog Number	Adapter Size	Insert Holder	Diameter øD	øD1	L	Weight (lbs.)
CKB4-EWN41EDP-185	CKB4	10.626.141	1.614-2.162	1.540	7.283	5.0
		10.626.142	1.969-2.480			
		10.626.143	2.402-2.913			
CKB5-EWN53EDP-210	CKB5	10.626.151	2.087-2.756	1.968	8.268	9.7
		10.626.152	2.559-3.228			
		10.626.153	3.070-3.740			
CKB6-EWN68EDP-240	CKB6	10.626.161	2.677-3.937	2.520	9.449	18.3
		10.626.162	3.700-4.960			
		10.626.163	4.646-5.906			

- The minimum boring range represents the range when insert with .016" nose radius is used
- Insert must be ordered separately, the suitable size is TC11
- Designed to be capable of supplying coolant through body

SMART DAMPER BORING EWD Finishing Head—Digital Readout

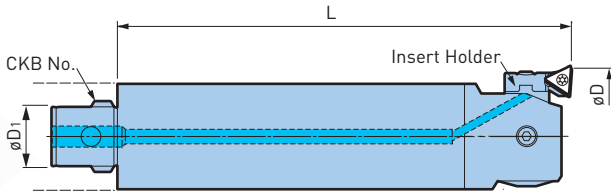

Catalog Number	Adapter Size	Insert Holder	Diameter øD	øD1	L	Weight (lbs.)
10.389.395 CKB4-EWD41SD-200	CKB4	10.626.141	1.614-2.162	1.540	7.874	5.5
		10.626.142	1.969-2.480			
		10.626.143	2.402-2.913			
10.389.396 CKB5-EWD53SD-225	CKB5	10.626.151	2.087-2.756	1.968	8.858	10.3
		10.626.152	2.559-3.228			
		10.626.153	3.070-3.740			
10.389.397 CKB6-EWD68SD-260	CKB6	10.626.161	2.677-3.937	2.520	10.236	18.7
		10.626.162	3.700-4.960			
		10.626.163	4.646-5.906			

- The minimum boring range represents the range when insert with .016" nose radius is used
- Insert must be ordered separately, the suitable size is TC11
- Designed to be capable of supplying coolant through body

SERIES 310—INSERT HOLDERS TYPE E

Standard holder with 87° entering angle, suitable for fine boring in through and blind holes. Three different insert holders for the extension of the diameter range and for back boring applications.

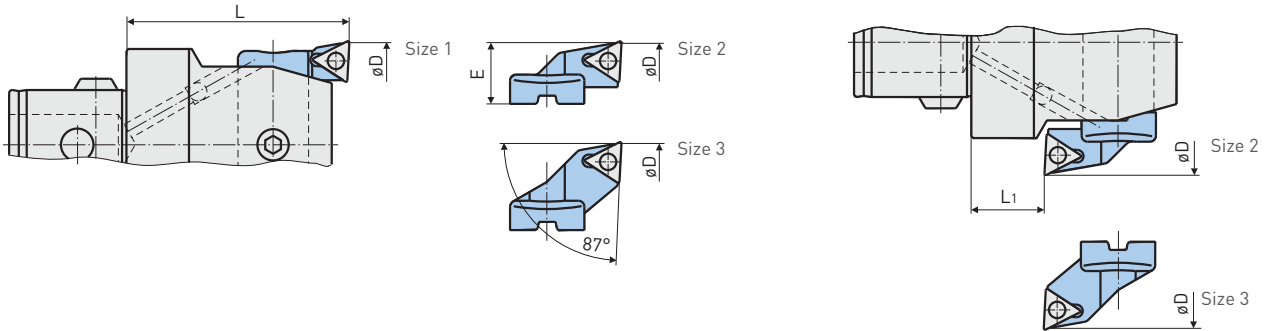

Head Type	Catalog Number	Reference Number	Front Boring ϕD	Back Boring ϕD	E	Insert
EWN20	ENH1-1T	10.626.111	.787-1.024	—	.183	TP07
	-2T	10.626.112	.984-1.220	1.102-1.220	.281	
	-3T	10.626.113	1.181-1.417	1.181-1.417	.380	
EWN25	ENH2-1T	10.626.121	.984-1.299	—	.215	
	-2T	10.626.122	1.260-1.575	1.417-1.575	.352	
	-3T	10.626.123	1.535-1.850	1.535-1.850	.490	
EWN32	ENH3-1T	10.626.131	1.260-1.654	—	.291	TC11
	-2T	10.626.132	1.614-2.008	1.811-2.008	.469	
	-3T	10.626.133	1.969-2.362	1.969-2.362	.646	
EWE/D/N41	ENH4-1T	10.626.141	1.614-2.126	—	.319	
	-2T	10.626.142	1.969-2.480	2.087-2.480	.496	
	-3T	10.626.143	2.402-2.913	2.402-2.913	.713	
EWE/D/N53	ENH5-1T	10.626.151	2.087-2.756	2.441-2.756	.394	
	-2T	10.626.152	2.559-3.228	2.717-3.228	.630	
	-3T	10.626.153	3.070-3.740	3.070-3.740	.886	
EWE/D/N68	ENH6-1T	10.626.161	2.677-3.937	3.151-3.937	.492	
	-2T	10.626.162	3.700-4.960	3.700-4.960	1.004	
	-3T	10.626.163	4.646-5.906	4.646-5.906	1.476	
EWE/N100	-1T	10.626.161	3.937-6.024	4.409-6.024	.492	
	-2T	10.626.162	4.960-7.047	4.960-7.047	1.004	
	-3T	10.626.163	5.906-8.000	5.906-8.000	1.476	

ACCESSORIES



INSERTS
PG. 506



APPLICATION
ADVICE
PG. 472

SERIES 310—INSERT HOLDER TYPE C

With 90° approach angle, suitable for semi-finish and finish boring and for stepped bores. For each boring head, insert holders with different projections are available for the extension of the boring range and for back boring.

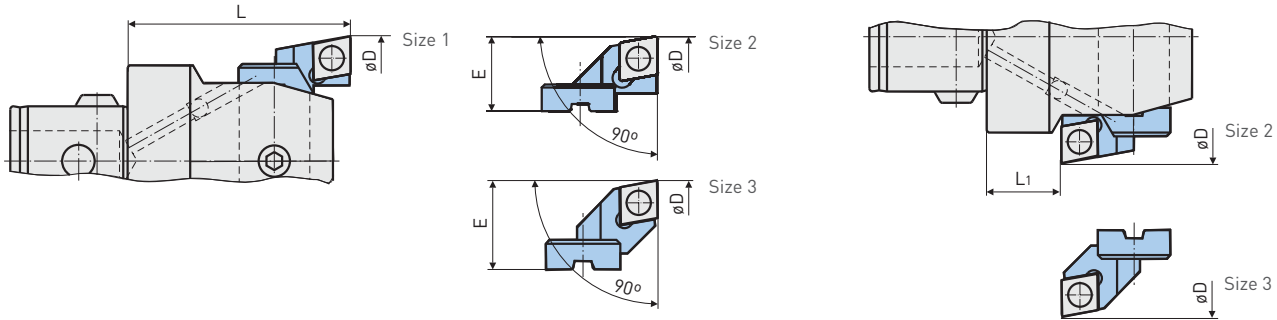

Head Type	Catalog Number	Reference Number	Front Boring øD	Back Boring øD	E	Insert	
EWN25	ENH2-2C	10.626.322	1.299-1.614	1.417-1.614	.352	CC06	
	-3C	10.626.323	1.535-1.850	1.535-1.850	.490		
EWN32	ENH3-1C	11.626.331	1.260-1.654	—	.291		
	-2C	10.626.332	1.614-2.008	1.811-2.008	.469		
	-3C	10.626.333	1.969-2.362	1.969-2.362	.646		
EWE/D/N41	ENH4-1C	11.626.341	1.614-2.126	—	.319		
	-2C	10.626.342	1.969-2.480	2.087-2.480	.496		
	-3C	10.626.343	2.402-2.913	2.402-2.913	.713		
EWE/D/N53	ENH5-1C	11.626.351	2.087-2.756	2.441-2.756	.394		CC09
	-2C	10.626.352	2.441-3.110	2.756-3.110	.630		
	-3C	10.626.353	3.070-3.740	3.070-3.740	.886		
EWE/D/N68	ENH6-1C	11.626.361	2.677-3.937	3.151-3.937	.492		
	-2C	10.626.364	3.700-4.960	3.700-4.960	1.004		
	-3C	10.626.363	4.252-5.512	4.252-5.512	1.280		
EWE/N100	-1C	11.626.361	3.937-6.024	4.409-6.024	.492		
	-2C	10.626.364	4.960-7.047	4.960-7.047	1.004		
	-3C	10.626.363	5.512-7.600	5.512-7.600	1.280		

ACCESSORIES



INSERTS
PG. 506



APPLICATION
ADVICE
PG. 472

SERIES 310—BLANK INSERT HOLDER TYPE ENH

If required, the blanks can be hardened. (H11 Tool Steel)

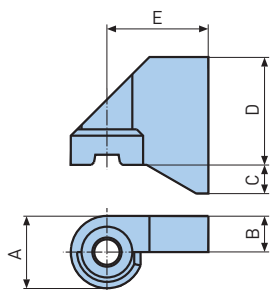

Head Type	Catalog Number	Reference Number	A	B	C	D	E
EWN20	ENH1-B	10.626.901	.331	.165	.103	.433	.465
EWN25	ENH2-B	10.626.902	.409	.205	.124	.394	.677
EWN32	ENH3-B	10.626.903	.449	.224	.177	.669	.630
EWN41	ENH4-B	10.626.904	.606	.303	.197	.787	.787
EWN53	ENH5-B	10.626.905	.748	.374	—	.984	.787
EWN68/100	ENH6-1B	10.626.906	1.142	.571	—	1.575	1.024
	ENH6-2B	10.626.916					1.969

SERIES 310—INSERT HOLDERS 30°

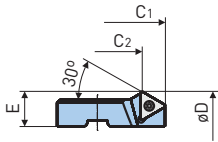

Head Type	Catalog Number	Reference Number	øD	E	C1	C2	Insert
EWN25	ENH2-1T30	11.380.321	1.102-1.417	.274	1.398	1.173	TP07
EWN32	ENH3-1T30	11.380.322	1.417-1.811	.370	1.654	1.311	TC11
EWE/D/N41	ENH4-1T30	11.380.323	1.772-2.283	.398	1.929	1.587	
EWE/D/N53	ENH5-1T30	11.380.324	2.205-2.874	.453	2.244	1.906	
EWE/D/N68	ENH6-1T30	11.380.325	2.677-3.937	.492	2.795	2.453	
EWE/N100	ENH6-1T30	11.380.325	3.937-6.024	.492	3.425	3.093	

SERIES 310—INSERT HOLDERS 45°

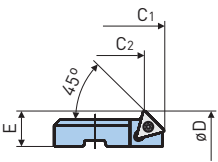

Head Type	Catalog Number	Reference Number	øD	E	C1	C2	Insert
EWN25	ENH2-1T45	11.380.326	1.102-1.417	.274	1.398	1.213	TP07
EWN32	ENH3-1T45	11.380.327	1.417-1.811	.370	1.654	1.370	TC11
EWE/D/N41	ENH4-1T45	11.380.328	1.772-2.283	.398	1.929	1.646	
EWE/D/N53	ENH5-1T45	11.380.329	2.205-2.874	.453	2.244	1.961	
EWE/D/N68	ENH6-1T45	11.380.330	2.677-3.937	.492	2.795	2.512	
EWE/N100	ENH6-1T45	11.380.330	3.937-6.024	.492	3.425	3.142	

SERIES 310—INSERT HOLDERS 25°

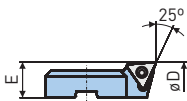

Head Type	Catalog Number	Reference Number	øD	E	Insert
EWN32	ENH3-1T25	10.689.197	1.260-1.654	.291	TC11
EWE/D/N41	ENH4-1T25	11.380.306	1.614-2.126	.319	
EWE/D/N53	ENH5-1T25	11.380.341	2.087-2.756	.394	
EWE/D/N68	ENH6-1T25	11.380.587	2.677-3.937	.492	
EWE/N100	ENH6-1T25	11.380.587	3.937-6.024	.492	

ACCESSORIES



BACK BORING INSTRUCTIONS

For back boring, it is required to enter into the bore off centre, with a tool adjusted to the back bore diameter. In this respect, the back bore diameter «D» as well as the diameters of the entry bore «C» and the tool body «A», are related to each other. In order to check the feasibility of the back boring operation and to select the best possible tool combination, these values can be calculated as follows:

Example:
Calculation of the minimum entry bore diameter «C».

Given:
Back Bore Diameter øD=93mm
Tool Combination EWN53, with Insert Holder No. 3, øD1=50 mm

$$C = \frac{\text{øD} + \text{øD1}}{2} = \frac{93 + 50}{2} = 71.5\text{mm}$$

CAUTION ⚠

Counter clockwise spindle rotation is required for back boring operations. The cutting edge is at a shorter length than the boring head. Consider total length of tool. Check the space at the back side of the work piece

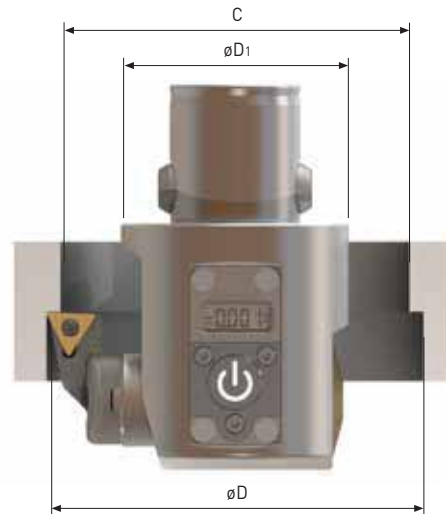

Min Entry Bore Diameter «C»
 $C = \frac{\text{øD} + \text{øD1}}{2}$

Max Back Bore Diameter «øD»
 $\text{øD} = 2C - \text{øD1}$

Max Tool Body Diameter «øD1»
 $\text{øD1} = 2C - \text{øD}$

SERIES 310—FACE GROOVING INSERT HOLDERS

RANGE: $\phi 2.087''$ - $119.700''$

The insert holders and inserts are made for face grooving with the fine boring heads EWN and EWE Series 310 and with the large diameter boring tools Series 317 and 318.

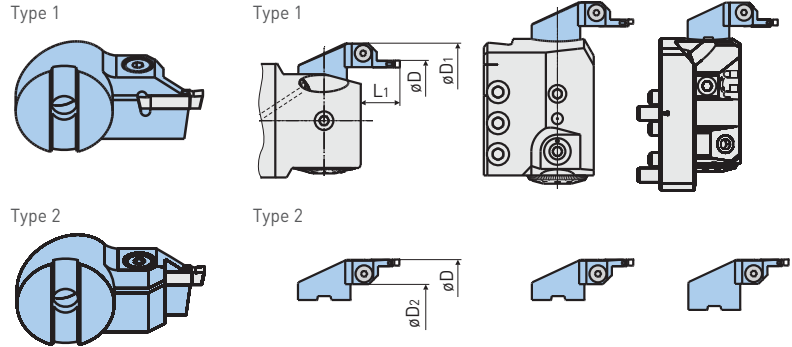

Head Type	L ₁	Type 1				Type 2			
		Catalog Number	Reference Number	øD	øD ₁	Catalog Number	Reference Number	øD	øD ₂
EWE/D/N53	.787	ENH5-1FG4	10.626.935	2.087-2.756	øD+.866	ENH5-2FG4R	10.626.945	2.874-3.543	øD-1.181
EWE/D/N68		ENH6-1FG4	10.626.936	2.677-3.937	øD+.945	ENH6-2FG4R	10.626.946	3.465-4.724	øD+1.102
		ENH6-2FG4	10.626.937	3.701-4.961		ENH6-3FG4R	10.626.947	4.488-5.748	
EWE/N100	.827	ENH6-1FG4	10.626.936	3.937-6.024	øD+.945	ENH6-2FG4R	10.626.946	4.724-6.811	øD+1.102
		ENH6-2FG4	10.626.937	4.961-7.047		ENH6-3FG4R	10.626.947	5.748-7.835	
EWE/N200		ENH7-1FG4	10.626.938	7.874-118.100	øD+.827	ENH7-2FG4R	10.626.948	8.661-119.700	

ACCESSORIES



INSERTS

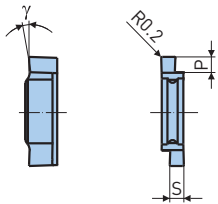

Inserts for Steel and Cast Iron			
S	P	θ	Catalog Number
.098	.106	5°	10.958.425
.118	.130	5°	10.958.430
.130	.142	5°	10.958.433
.138	.150	5°	10.958.435
.157	.169	5°	10.958.440

Inserts for Aluminum			
S	P	θ	Catalog Number
.098	.106	5°	10.958.475
.118	.130	5°	10.958.480
.130	.142	5°	10.958.483
.138	.150	5°	10.958.485
.157	.169	5°	10.958.490

GROOVE DIMENSIONS

Recommended groove dimensions for given cross section diameters of O-rings, for static sealing.

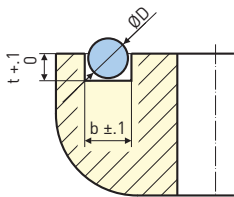

øD	Groove Width b	Groove Depth t
.070	.098	.051
.079	.098	.063
.098	.130	.075
.103	.138	.081
.118	.157	.094

Work Piece Material	Speed (SFM)	Feed (IPR)
Construction-Heat Treatable Steels	400-600	.0004-.0012
Stainless Steels	200-400	.0004-.0008
Cast Iron	260-530	.0008-.0016
Aluminum	660-1320	.0008-.0016
Non-Ferrous Metals		

OD TURNING WITH EWN/EWE

RANGE: $\varnothing.630''-4.724''$

This program consists of tool holders with CKB5 and CKB6 connectors, made for different turning ranges and with tool connections in the sizes CKB3, CKB4 and CKB5. The corresponding precision finish or rough boring heads and counterweights can be mounted on the tool holder either directly or by means of an extension. With this program, outer diameters in the range from $\varnothing.630-4.724$ can be machined.

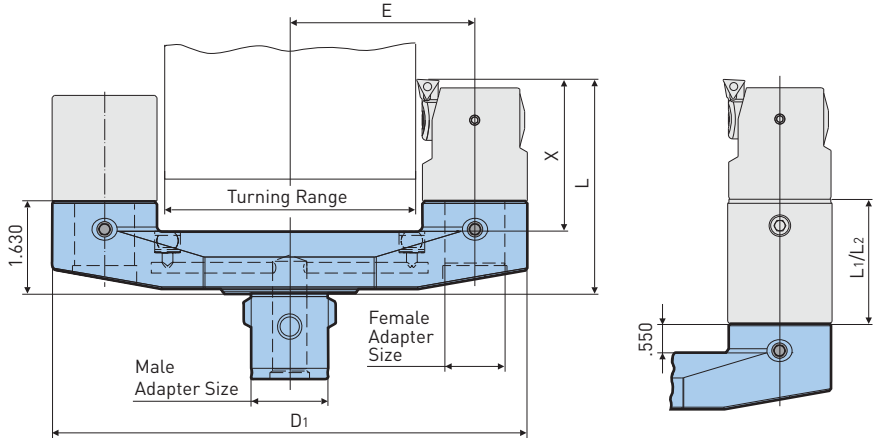

Catalog Number	Reference Number	CK (1)	CK (2)	$\varnothing D1$	E	L*	X*	Weight (lbs.)
OD16-44CKB5-CKB3	10.335.906	CKB5	CKB3	4.213	1.496	3.268 [4.449] [5.039]	2.008 [3.189] [3.780]	5.9
-44CKB6-CKB3	10.335.905	CKB6	CKB3	4.213	1.496	3.268 [4.449] [5.039]	2.008 [3.189] [3.780]	3.2
OD34-67CKB6-CKB4	10.335.904	CKB6	CKB4	5.787	2.126	3.543 [5.118] [5.906]	2.283 [3.858] [4.646]	3.9
OD57-90CKB6-CKB4	10.335.903	CKB6	CKB4	6.693	2.579	3.543 [5.118] [5.906]	2.283 [3.858] [4.646]	4.6
OD78-120CKB6-CKB5	10.335.902	CKB6	CKB5	8.740	3.406	3.937 [6.299] [7.480]	2.677 [5.039] [6.220]	6.1

*The numbers in brackets indicate the tool length (L) and the max. pin length (X) with the use of the corresponding extensions

ACCESSORIES



CAUTION

Counter-clockwise rotation of spindle!
Vc max 1,500 SFM

Turning Adapter		Counterweight		Boring Head		Insert Holder		Turning Range
Catalog Number	Reference Number	Catalog Number	Reference Number	Catalog Number	Reference Number	Catalog Number	Reference Number	
OD16-44CKB5-CKB3	10.335.906	CW-CK3	10.335.915	EWN32-60E-CKB3	10.310.311	ENH3-3T	10.626.133	.630-1.024
						ENH3-2T	10.626.132	.984-1.378
						ENH3-1T	10.626.131	1.339-1.732
OD16-44CKB6-CKB3	10.335.905	CW-CK3	10.335.915	EWN32-60E-CKB3	10.310.311	ENH3-3T	10.626.133	.630-1.024
						ENH3-2T	10.626.132	.984-1.378
						ENH3-1T	10.626.131	1.339-1.732
OD34-67CKB6-CKB4	10.335.904	CW-CK4	10.335.913	EWN41-74E-CKB4	10.310.411	ENH4-3T	10.626.143	1.339-1.850
						ENH4-2T	10.626.142	1.772-2.283
						ENH4-1T	10.626.141	2.126-2.638
OD57-90CKB6-CKB4	10.335.903	CW-CK4	10.335.913	EWN41-74E-CKB4	10.310.411	ENH4-3T	10.626.143	2.244-2.756
						ENH4-2T	10.626.142	2.677-3.189
						ENH4-1T	10.626.141	3.031-3.543
OD78-120CKB6-CKB5	10.335.902	CW-CK5	10.335.912	EWN53-95E-CKB5	10.310.511	ENH5-3T	10.626.153	3.071-3.740
						ENH5-2T	10.626.152	3.583-4.252
						ENH5-1T	10.626.151	4.055-4.724

SERIES 309 EWB-UP

Peak Performance and Precision Uniquely Combined

GRADUATED HEADS, 1 DIV = .00005"/ ϕ , ϕ .984"-3.937" (1 Div = .001mm/ ϕ , ϕ 25mm-100mm)

Diameter adjustments in the sub-micron range and balance qualities of G6.3 are requirements for tight tolerance bores with maximum RPM's.

US PATENT #
7,585,139

MAX
20,000
RPM

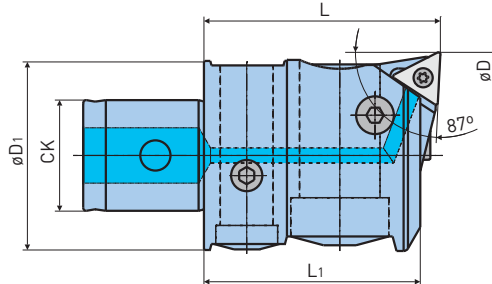

HIGHEST
ACCURACY & SPEED

Catalog Number	Reference Number	CK	ϕD	ϕD_1	L	L ₁	Weight (lbs.)	Insert
EWB25-32E-UP-CK2	10.309.211	CK2	.984-1.299	.921	1.398	1.280	.3	TP07
EWB32-42E-UP-CK3	10.309.311	CK3	1.260-1.654	1.181	1.575	1.457	.5	TC11
EWB41-54E-UP-CK4	10.309.411	CK4	1.614-2.126	1.496	1.850	1.693	.9	TC11
EWB53-70E-UP-CK5	10.309.511	CK5	2.087-2.756	1.929	2.244	2.087	1.9	TC11
EWB68-100E-UP-CK6	10.309.611	CK6	2.677-3.937	2.520	2.795	2.646	4.0	TC11

- Insert holders are included with EWB-UP boring heads

SERIES 310 EWN/EWB APPLICATION INFORMATION

Autobalance boring heads, Series 310 EWB, maintain perfect balance throughout the work range due to the integrated counter-balance mechanism. The counterweight can only compensate for one size insert holder, so the work range is similar to EWN heads with a Size 1 insert holder.

Series 310 EWN boring heads are pre-balanced at one position only; the mid-range of the tool carrier travel with a Size 1 insert holder. Adjustment of the bore diameter from this position and/or use of Size 2 and 3 insert holders will require reduction of cutting speed values due to increased unbalance forces.

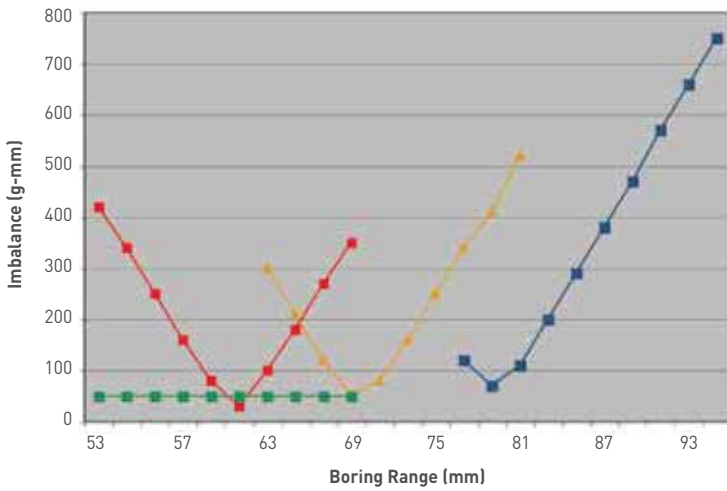

- 10.626.151-EWN Insert Holder Size 1
- 10.626.152-EWN Insert Holder Size 2
- 10.626.153-EWN Insert Holder Size 3
- 10.310.515A-EWB

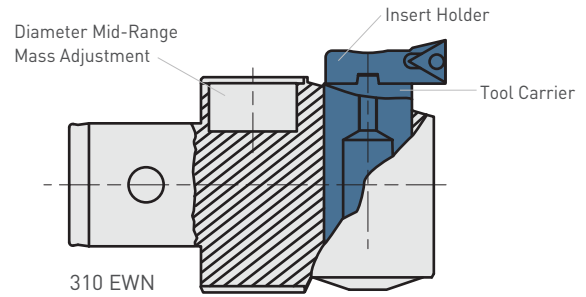
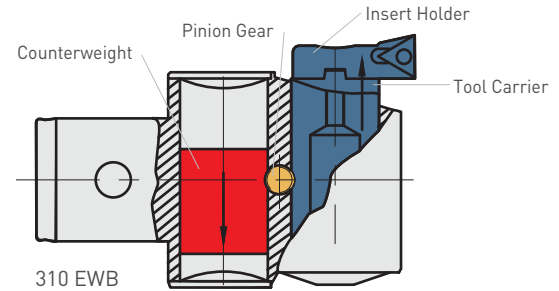

EWB BALANCED FINE BORING HEAD

RANGE: ϕ 1.260"-4.134" (ϕ 2-105mm)

Even at max. speeds balanced tools guarantee vibration-free boring, resulting in increased productivity and highest precision.

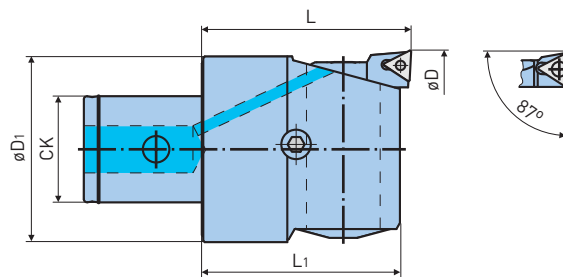

Catalog Number	Reference Number	CK	øD	øD1	L	L1	Weight (lbs.)	Insert
EWB32-42E-CK3	10.310.315A	CK3	1.260-1.654	1.181	1.575	1.457	.5	TP07
EWB41-54E-CK4	10.310.415A	CK4	1.614-2.126	1.496	1.850	1.693	.9	TC11
EWB53-70E-CK5	10.310.515A	CK5	2.087-2.756	1.929	2.244	2.087	1.8	TC11
EWB68-88E-CK6	10.310.615A	CK6	2.677-3.465	2.480	2.795	2.646	3.7	TC11
EWB85-105E-CK6	10.310.616A		3.346-4.134	2.480	2.795	2.646		

- EWB boring heads will be delivered with assembled insert holder

ACCESSORIES

<p>SPARE PARTS PG. 475</p>	<p>INSERTS PG. 506</p>	<p>APPLICATION ADVICE PG. 472</p>
--------------------------------	----------------------------	---

EWB-AL BALANCED FINE BORING HEAD

RANGE: $\phi 3.937''$ - $8.000''$ ($\phi 100$ - 203 mm)

The fine boring heads EWB-AL are made of high strength aluminium with hard coating. Together with reductions and extensions made in the same way, the weight for long and large diameter tool combinations is reduced by more than 50%.

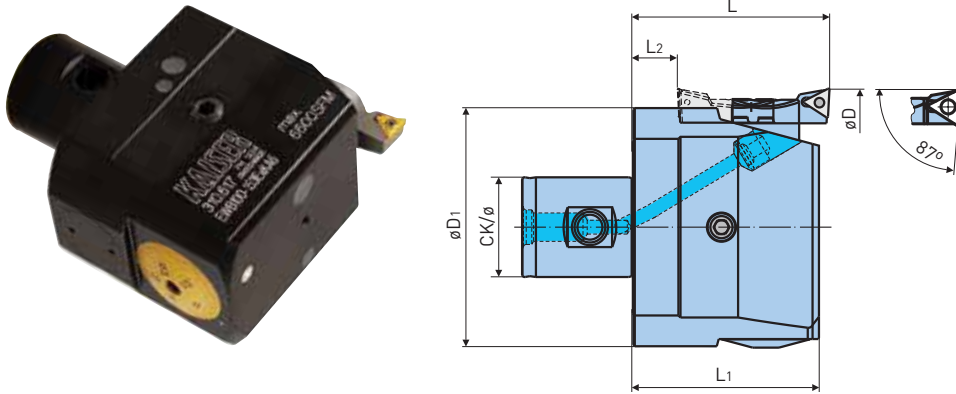

Catalog Number	Reference Number	CK	ϕD	$\phi D1$	L	L1	Weight (lbs.)	Insert
EWB100-153E-CK6AL	10.310.617	CK6	3.937-6.024	3.543	2.795	2.638	1.3	TC11
EWB150-203E-CK6AL	10.310.618		5.906-8.000	4.961	2.795	2.638	1.8	
EWB100-153E-CK7AL	10.310.715	CK7	3.937-6.024	3.543	3.425	3.268	2.0	TC11
EWB150-203E-CK7AL	10.310.716		5.906-8.000	4.961	3.425	3.268	2.6	

- EWB-AL boring heads will be delivered with assembled insert holder.

ACCESSORIES

 SPARE PARTS PG. 475	 INSERTS PG. 506	 APPLICATION ADVICE PG. 472
---	---	---

CKB CARBIDE BORING BAR

For Finishing

Tool combinations with carbide boring bars provide optimum rigidity when machining extremely long bores.

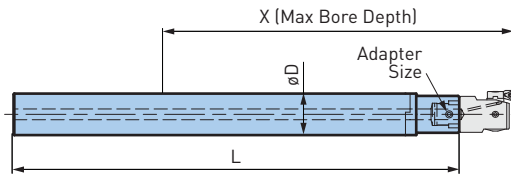

Catalog Number	Reference Number	CK	øD	L	X	Bore Diameter		Weight (lbs.)	
						Min	Max		
ST19-CKB1-140HM	10.335.320	CKB1	19mm	5.512	4.921	.787	1.417	1.0	
-190HM	10.335.321			7.480	6.890	.787	1.417	1.6	
-240HM	10.335.322			9.449	8.858	.787	1.417	2.1	
ST21-CKB1-140HM	10.335.380		CKB1	21mm	5.512	4.921	.866	1.417	1.3
-190HM	10.335.381				7.480	6.890	.866	1.417	1.8
-240HM	10.335.382				9.449	8.858	.866	1.417	2.2
ST23-CKB1-140HM	10.335.383			23mm	5.512	4.921	.945	1.417	1.5
-190HM	10.335.384				7.480	6.890	.945	1.417	2.1
-240HM	10.335.385				9.449	8.858	.945	1.417	2.9
ST24-CKB2-160HM	10.335.323	CKB2	24mm	6.299	5.512	.984	1.850	1.9	
-220HM	10.335.324			8.661	7.874	.984	1.850	2.4	
-290HM	10.335.325			11.417	10.630	.984	1.850	3.9	
ST27-CKB2-160HM	10.335.386		27mm	6.299	5.512	1.102	1.850	2.3	
-220HM	10.335.387			8.661	7.874	1.102	1.850	3.4	
-290HM	10.335.388			11.417	10.630	1.102	1.850	4.5	
ST31-CKB3-200HM	10.335.326	CKB3	31mm	7.874	6.890	1.260	2.362	4.0	
-260HM	10.335.331			10.236	9.252	1.260	2.362	5.5	
-350HM	10.335.327			13.780	12.795	1.260	2.362	8.0	

CAUTION

These bars should not be used for heavy roughing.

ACCESSORIES

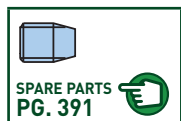

HYDRAULIC CHUCKS CLAMPING SYSTEM

For CKB Carbide Bars

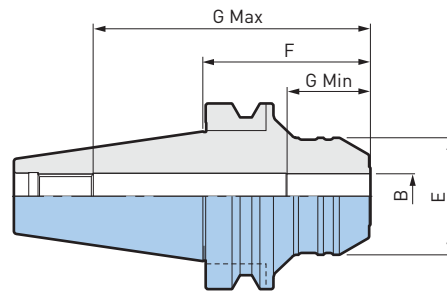

Taper	øB	Catalog Number	øE	F	G Min	G Max
CAT40	19mm	BCV40-HDC19-75	2.087	2.950	1.693	4.370
	24mm	-HDC24-75	2.480	2.950	1.772	4.094
	31mm	BCV40H-HDC31-80	2.913	3.150	2.205	2.992
CAT50	19mm	BCV50-HDC19L-90	1.937	3.543	1.693	5.866
	24mm	-HDC24L-90	2.480	3.543	1.772	5.866
	31mm	-HDC31L-90	2.913	3.543	2.205	5.787
BT40	19mm	BBT40-HDC19-75	1.937	2.950	1.693	4.370
	24mm	-HDC24-75	2.480	2.950	1.772	4.094
	31mm	-HDC31-75	2.913	2.950	2.205	2.992
BT50	19mm	BBT50-HDC19L-90	1.937	3.543	1.693	5.866
	24mm	-HDC24L-90	2.480	3.543	1.772	5.866
	31mm	-HDC31L-90	2.835	3.543	2.205	5.787
HSK-A63	31mm	HSK-A63-HDC31-95	2.480	3.740	2.205	2.750

STRAIGHT COLLET

Reduction sleeve for smaller diameter cutters.

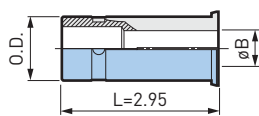

O.D.	øB	Catalog Number
31mm	21mm	OCA31-21
	23mm	OCA31-23
	27mm	OCA31-27

EW FINE BORING HEAD

RANGE: ϕ .590"-.866" (ϕ 15-22mm)

These heads are designed to be used in combination with the steel or carbide-boring bars ϕ 14mm and ϕ 16mm out of the accessory program. In conjunction with the long carbide bar, the tool is well suited for vibration-free finishing operations in bores with unfavorable ϕ/L -ratios.

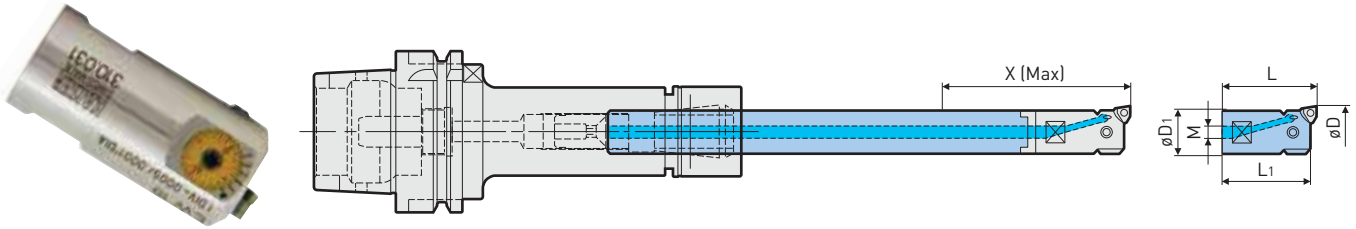

Catalog Number	Reference Number	ϕ D	ϕ D1	M	L	L1	Weight (lbs.)
EW15-19E-ST14	10.310.021	.590-.728	.551	M6	1.181	1.083	.1
EW18-22E-ST16	10.310.031	.708-.866	.6230	M10	1.417	1.299	.1

ACCESSORIES



INSERT HOLDERS

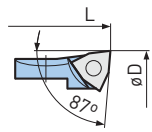

Head Type	Catalog Number	Reference Number	ϕ D	L	Insert
EW15	15EKWC02	10.625.020	.590-.728	1.181	WC02
EW18			.708-.866	1.417	

ACCESSORIES



BORING BARS

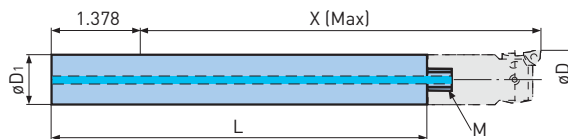

Boring Head		Catalog Number	Reference Number	Boring Bar				Weight (lbs.)
Type	ϕ D			ϕ D1	M	L	X (Max)	
EW15	.591-.728	ST14-87	10.615.232	.551	M6	3.425	3.228	.2
		-117HM	10.615.233			4.606	4.409	.6
		-147HM	10.615.221			5.787	5.591	.7
EW18	.709-.866	ST16-88	10.615.236	.625	M10	3.465	3.504	.3
		-108HM	10.615.237			4.252	4.291	.6
		-168HM	10.615.238			6.614	6.654	.9

FINISH BORING TROUBLESHOOTING

Under certain conditions, it may be necessary to modify or adapt recommended cutting data and/or tooling configurations of the application. Below are general solutions to common problems.

Problem	Possible Cause	Remedy
Poor Tool Life	Wrong insert grade	Change to higher wear resistant grade
	Excessive speed	Reduce SFM
	Poor cooling of insert	Apply through-tool coolant
	Excessive stock allowance	Decrease depth of cut
Chatter & Vibration	Excessive speed	Reduce SFM, check cutting data tables
	Extreme length/diameter ratio	Shorten tool to increase stiffness
		Increase boring bar diameter to larger size
		Change boring bar to carbide or heavy metal
	Wrong insert	Reduce nose radius of insert
Use ground geometry inserts (ie: TAN18 grade)		
Incorrect stock allowance	Check cutting data tables	
Poor Size Repeatability	Inaccurate tool changes	Worn and/or damaged tool shank; replace
		Clean spindle and tool shank
	Variation of stock allowance	Semi-finish with twin insert boring head
Unacceptable Roundness	Excessive boring tool imbalance	Use ground geometry inserts (ie: TAN18 grade)
		Change to auto-balance or balanceable head
		Balance tool assembly
	Excessive cutting forces	Reduce speed
	Insufficient workpiece clamping	Check stock allowance and feed rate
	Workpiece non-symmetrical	Check for uniform workpiece clamping
Unacceptable Position	Original bore off position	Reduce cutting forces; change to ground insert
	Excessive stock allowance	Increase cutting speed, reduce feed
		Semi-finish with twin insert boring head
		Decrease depth of cut
Poor Surface Finish	Wrong insert radius	Decrease insert radius
	Excessive feed rate	Reduce cutting forces; change to ground insert
	Poor chip evacuation	Use larger insert radius
		Increase bore to boring bar clearances
		Apply through-tool coolant; adjust nozzles
		Change insert to higher rake angle
Taper	Premature insert wear	Check depth of cut
		Change to higher wear resistance insert grade
		Increase insert radius
		Change from ground to pressed geometry insert
		Increase coolant flow

FINISH BORING INSERT SELECTION & CUTTING DATA

Recommended Under Optimal Conditions

- Length to diameter ratio less than 4:1
- Rigid fixture and workpiece
- Good machine spindle
- Setup not chatter prone
- Insert holder Size 1 (EWN)

Material	Insert Radius	Insert Type & Size				Stock Allow. On Dia.	Feed (IPR)	Speed (SFM)
		TP..07	TC..11	CC..06	CC..09			
Mild, Low-Carbon Steel 10xx-15xx 1018,1020,1551, A36	.008	10.651.802	11.656.352	11.654.856	—	.008-.012	.0020	1000-1450
	.016	10.651.702	11.655.322	11.654.865	11.654.959	.016-.020	.0040	
	.031	—	11.655.332	11.654.867	11.654.960	.024-.040	.0060	
High Carbon Alloy Steel 23xx-92xx, Tool Steel 4140, 4340, 8620	.008	10.651.802	11.656.352	11.654.856	—	.008-.012	.0020	800-1100
	.016	10.651.702	11.655.322	11.654.865	11.654.959	.016-.020	.0040	
	.031	—	11.655.332	11.654.867	11.654.960	.024-.040	.0060	
300 Stainless Steel Austenitic 303, 304, 316, 17-4ph	.008	10.651.802	11.656.352	11.654.856	—	.008-.012	.0020	550-800
	.016	10.651.702	11.655.322	11.654.865	11.654.959	.016-.020	.0040	
	.031	—	11.655.332	11.654.867	11.654.960	.024-.040	.0060	
400 Stainless Steel Martensitic 403, 410, 416, 430	.008	10.651.802	11.656.352	11.654.856	—	.008-.012	.0020	650-875
	.016	10.651.702	11.655.322	11.654.865	11.654.959	.016-.020	.0040	
	.031	—	11.655.332	11.654.867	11.654.960	.024-.040	.0060	
Grey Cast Iron Malleable Class 20, 30	.008	—	10.655.373	11.654.840	—	.008-.012	.0020	650-1000
	.012	10.651.735	—	—	—	.010-.014	.0030	
	.016	—	10.655.383	11.654.850	11.654.940	.016-.020	.0040	
	.031	—	10.655.393	11.654.860	11.654.952	.024-.050	.0060	
CBN-CH, CBN-CHN	—	11.938.872	11.938.833	11.938.835	11.938.838	.008-.016	.0030	1500-2000
Silicon Nitride Si3N4	—	—	—	11.654.841	11.654.951	.016-.026	.0050	1000-1200
Cast Iron Ductile/Nodular/Chilled	.008	—	10.655.301	11.654.840	—	.008-.012	.0020	375-625
	.012	10.651.632	—	—	—	.010-.014	.0030	
	.016	—	10.655.302	11.654.850	11.654.940	.016-.020	.0040	
	.031	—	10.655.303	11.654.860	11.654.952	.024-.040	.0060	
High Temp. Alloys Titanium, Inconel, Monel	.008	10.651.837	10.655.379	—	—	.006-.010	.0015	200-325
	.012	10.651.737	—	—	—	.008-.012	.0020	
	.016	—	10.655.389	11.654.868	11.654.968	.012-.016	.0020	
	.031	—	10.655.399	11.654.869	11.654.969	.018-.032	.0030	
Copper Alloys Brass, Bronze	.008	—	11.655.315	—	—	.008-.012	.0020	1100-1800
	.012	10.651.623	—	—	—	.010-.014	.0030	
	.016	—	11.655.325	11.654.858	11.654.957	.016-.020	.0040	
	.031	—	11.655.335	11.654.864	11.654.958	.024-.050	.0060	
Aluminum/Magnesium 6061, 7075	.008	10.651.825	10.655.378	10.654.877	—	.008-.012	.0020	1200-1600
	.016	10.651.725	10.655.387	10.654.888	10.654.977	.016-.020	.0040	
	.031	11.651.923	10.655.397	10.654.898	10.654.987	.024-.040	.0060	
Aluminum/Magnesium 6061, 7075 PCD Inserts	.008	—	11.938.861	11.938.847	—	.008-.012	.0020	2000-4000
	.012	10.938.840	—	—	—	.010-.014	.0030	
	.016	—	10.938.841	11.938.842	11.938.843	.016-.020	.0040	
	.031	11.938.830	11.938.860	—	11.938.851	.024-.050	.0060	
Hardened Steel Min. 50HRc CBN Inserts	.008	—	—	—	—	.004-.008	.0010	200-300
	.012	10.938.837	—	—	—	.004-.008	.0010	
	.016	—	10.938.834	11.938.835	11.938.838	.005-.010	.0015	
	.031	—	10.938.865	—	—	.006-.012	.0020	

All cutting data without guarantee

Cutting Speed:
 $RPM = \frac{SFM \times 3.82}{Bore \ \phi}$

Feed Rate:
 $IPM = RPM \times IPR$

FINISH BORING INSERT SELECTION & CUTTING DATA

Recommended Under Critical Conditions

- Length to diameter ratio over 5:1
- Unstable fixture and/or workpiece
- Excessive spindle looseness
- Setup chatter prone
- Insert holder Size 2 and 3 (EWN)

Materials	Insert Radius	Insert Type & Size				Stock Allow on Dia.	Feed (IPR)	Speed (SFM)
		TP..07	TC..11	CC..06	CC..09			
Mild, Low-Carbon Steel 10xx-15xx 1018,1020,1551, A36	.004	10.651.824	10.655.363	—	—	.003-.006	.0010	525-675
	.008	10.651.835	10.655.372	11.654.840	—	.006-.010	.0015	
	.012	10.651.736	—	—	—	.010-.014	.0020	
	.016	—	10.655.386	11.654.850	11.654.940	.014-.020	.0020	
High Carbon Alloy Steel 23xx-92xx, Tool Steel 4140, 4340, 8620	.004	10.651.824	10.655.363	—	—	.003-.006	.0010	400-550
	.008	10.651.835	10.655.372	11.654.840	—	.006-.010	.0015	
	.012	10.651.736	—	—	—	.010-.014	.0020	
	.016	10.651.734	10.655.386	11.654.850	11.654.940	.014-.020	.0020	
300 Stainless Steel Austenitic 303, 304, 316, 17-4ph	.004	10.651.824	10.655.363	—	—	.003-.006	.0010	350-525
	.008	10.651.837	10.655.379	—	—	.006-.010	.0015	
	.012	10.651.737	—	—	—	.010-.014	.0020	
	.016	10.651.734	10.655.389	11.654.845	11.654.968	.014-.020	.0020	
400 Stainless Steel Martensitic 403, 410, 416, 430	.004	10.651.824	10.655.363	—	—	.003-.006	.0010	425-550
	.008	10.651.837	10.655.379	—	—	.006-.010	.0015	
	.012	10.651.737	—	—	—	.010-.014	.0020	
	.016	10.651.734	10.655.389	11.654.845	11.654.968	.014-.020	.0020	
Grey Cast Iron Malleable Class 20, 30	.004	10.651.824	10.655.363	—	—	.003-.006	.0010	350-500
	.008	10.651.833	10.655.373	—	—	.006-.010	.0020	
	.012	10.651.735	—	—	—	.010-.014	.0020	
	.016	10.651.734	10.655.383	11.654.868	11.654.968	.014-.020	.0030	
Cast Iron Ductile/Nodular/Chilled	.004	10.651.824	10.655.363	—	—	.003-.006	.0010	250-350
	.008	—	10.655.373	—	—	.006-.010	.0020	
	.012	10.651.623	—	—	—	.010-.014	.0020	
	.016	—	10.655.383	11.654.868	11.654.968	.014-.020	.0030	
High Temp. Alloys Titanium, Inconel, Monel	.008	10.651.837	10.655.379	—	—	.006-.010	.0020	125-250
	.012	10.651.737	—	—	—	.010-.014	.0020	
	.016	—	10.655.389	11.654.963	11.654.957	.014-.020	.0030	
Copper Alloys Brass, Bronze	.008	—	11.655.315	—	—	.006-.010	.0015	400-700
	.012	10.651.623	—	—	—	.010-.014	.0020	
	.016	—	11.655.325	11.654.858	11.654.957	.014-.020	.0020	
Aluminum/Magnesium 6061, 7075	.004	10.651.823	—	—	—	.003-.006	.0010	600-1100
	.008	10.651.825	10.655.378	10.654.877	—	.006-.010	.0020	
	.012	10.651.723	—	—	—	.010-.014	.0020	
	.016	10.651.725	10.655.388	10.654.888	10.654.977	.014-.020	.0030	

All cutting data without guarantee

Cutting Speed:
 $RPM = \frac{SFM \times 3.82}{Bore \ \phi}$



Feed Rate:
 $IPM = RPM \times IPR$



Maximum speed of 310 EWB: 6,600 SFM, Maximum speed of 310 EWN: 4,000 SFM

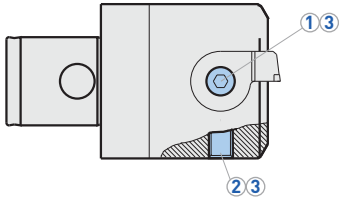





**SERIES 310 EWN
SPARE PARTS**

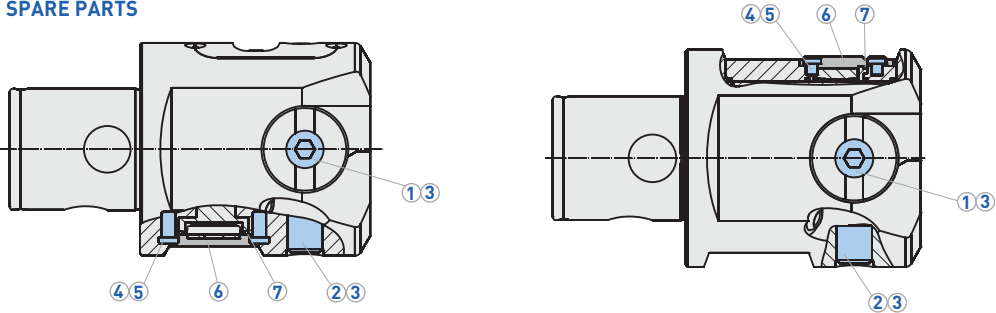

Head Type		Torque (ft.-lbs.)		Torque (ft.-lbs.)	
	Screw (1)		Screw (2)		Wrench (3)
EWN 20	10.690.135	.7	10.690.410	.4	10.690.811
EWN 25	10.690.136	.7	10.690.549	.4	10.690.811
EWN 32	10.690.137	1.8	10.690.550	1.1	10.690.812
EWN 41	10.690.138	2.2	10.690.551	1.8	10.690.813
EWN 53	10.690.139	4.4	10.690.552	4.4	10.690.814
EWN 68	10.690.141	8.9	10.690.553	7.4	10.690.816
EWN 100	10.690.141	8.9	10.690.553	7.4	10.690.816

**SERIES 310/318 EWD/EWE
SPARE PARTS**



Head Type		Torque (ft.-lbs.)		Torque (ft.-lbs.)		Screw (4)	Torque (ft.-lbs.)			
	Screw (1)		Screw (2)		Wrench (3)			Wrench (5)	Cover (6)	O-Ring (7)
EWD41	10.690.138	2.2	10.690.997	1.8	10.690.813	10.690.994	.7	10.694.808	10.310.905	10.692.381
EWD53	10.690.139	4.4	10.690.996	4.4	10.690.814					
EWD68	10.690.141	8.9	10.690.469	7.4	10.690.816					
EWD100			10.690.553							
EWD200	10.690.140	8.9	10.690.469	8.9	10.690.816					
EWBD68			10.690.580							
EWBD100AL										
EWE41	10.690.138	2.2	10.690.997	1.8	10.690.813	10.690.326	.7	10.694.808	10.395.170	10.395.161
EWE53	10.690.139	4.4	10.690.996	4.4	10.690.814					
EWE68	10.690.141	8.9	10.690.469	7.4	10.690.816					
EWE100			10.690.553		10.690.816					
EWE200	10.690.140	8.9	10.690.469	8.9	10.690.816					

FINE BORING **B.3**

SERIES 309 EWB-UP SPARE PARTS

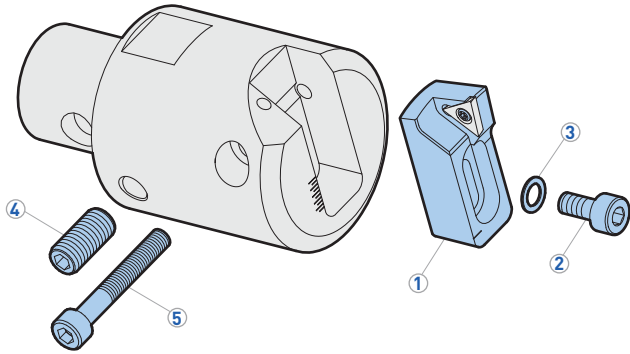

Head Type	Insert Holder (1)	Mounting Screw (2)	Washer (3)	Torque (ft.-lbs.)	Locking Screw (4)	Torque (ft.-lbs.)	Head Clamping (5)	Torque (in.-lbs.)
EWB25UP	10.627.121	10.690.182	10.693.289	.8	-	.8	10.690.940	.8
EWB32UP	10.627.131	10.690.179	10.693.186	1.1	10.690.550	1.1	10.690.180	1.1
EWB41UP	10.627.141	10.690.176	10.693.175	1.8	10.690.943	1.8	10.690.115	1.8
EWB53UP	10.627.151	10.690.177	10.693.176	2.9	10.690.658	2.9	10.690.178	2.9
EWB68UP	10.627.161	10.690.953	10.693.177	3.7	10.690.591	3.7	10.690.156	3.7

SERIES 310 EWB SPARE PARTS

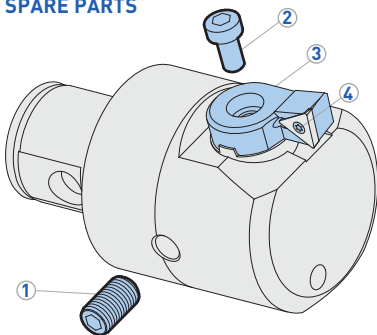

Head Type	Locking Screw (1)		Mounting Screw (2)		Boring Head Wrench	Insert Holders (3)	Insert Screws (4)
	Catalog Number	Torque (in.-lbs.)	Catalog Number	Torque (in.-lbs.)			
EWB32	10.690.577	1.7	10.690.137	1.7	10.690.812	10.626.231	10.694.103
EWB41	10.690.578	2.1	10.690.138	2.1	10.690.813	10.626.241	10.694.122
EWB53	10.690.579	4.2	10.690.139	4.2	10.690.814	10.626.251	10.694.122
EWB68	10.690.580	8.8	10.690.140	8.8	10.690.816	10.626.261	10.694.122
EWB85	10.690.580	8.8	10.690.140	8.8	10.690.816	10.626.261	10.694.122
EWB100	10.690.580	8.8	10.690.140	8.8	10.690.816	10.626.261	10.694.122
EWB150	10.690.580	8.8	10.690.140	8.8	10.690.816	10.626.261	10.694.122

CAUTION

DO NOT substitute insert holders from program EWN.

SERIES 310 EW SPARE PARTS

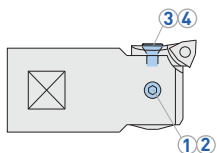

Head Type	Screw (1)	Torque (ft.-lbs.)	Wrench (2)	Screw (3)	Torque (ft.-lbs.)	Wrench (4)
EW 15	10.690.414	.4	10.690.819	10.694.120	.9	10.694.807
EW 18	10.690.416	.4	10.690.819		.9	10.694.807

LARGE DIAMETER BORING

B.4



B.4

LARGE DIAMETER BORING

LARGE DIAMETER BORING HEADS**478-504**

LARGE DIAMETER BORING HEADS OVERVIEW	478-479
SERIES 318	480-489
BRIDGE TOOL HOLDER	490-491
SHANKS FOR SERIES 318	492
SAFETY INSTRUCTIONS & APPLICATION NOTES	493
INSERT SELECTION & CUTTING DATA	494-495
SPARE PARTS	496-497
SPECIAL TOOLS	498-499
ACCESSORIES	500-501
SPECIAL CK SHANKS	502-504

The system is based on aluminum extension slides of different lengths, which support a variety of aluminum and steel components for roughing and finishing tool assemblies. The mounting components are pinned to fit onto specific locations on the slides, and secured with steel bolts. The precise positioning of the components on the slide along with incremental adjustment scales for insert holders permit diameter and length setting without a tool presetter.

SERIES 318 WITH FLANGE ONLY



Execution with flange only. Especially built to fit on machine tools with 40 taper spindle. For rough and fine boring, OD turning, chamfering and face grooving.

ø7.87"-13.39" (ø200-340mm)
CKB6/CKN6

PG. 479

SERIES 318 WITH FLANGE AND EXTENSION SLIDE



Edition with flange and extension slides. For rough and fine boring, OD turning, chamfering and face grooving.

ø7.87"-24.41" (ø200-620mm)
CKB7/CKN7

PG. 479

SERIES 318 WITH BRIDGE AND EXTENSION SLIDES



Edition with shanks, large bridges and extension slides. For rough and fine boring, OD turning and face grooving.

ø24.41"-118.11" (ø620-3000mm)
DV50/BT50/HSK-A100

PG. 488

SERIES 318 WITH FLANGE ONLY

RANGE: $\varnothing 7.87''$ - $13.39''$



SERIES 318 WITH FLANGE AND EXTENSION SLIDE

RANGE: $\varnothing 7.87''$ - $24.41''$



FLANGES

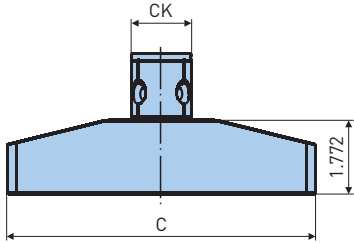

Fig. 1

Catalog Number	Reference Number	Fig.	Boring Range	CK	C	Max RPM	Weight (lbs.)
CKB6-FL200-270	10.318.205	1	7.87-10.63	CKB6	7.283	3200	4.0
-FL200-270	10.318.205N						
-FL270-340	10.318.206		10.63-13.39		10.039	2400	5.1
-FL270-340	10.318.206N						

STANDARD EXECUTION

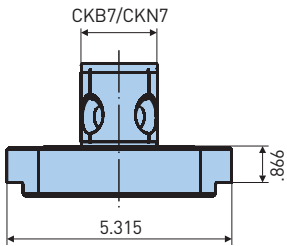

Fig. 2

FLANGE WITH CUTTER POSITION ROTATED 90°

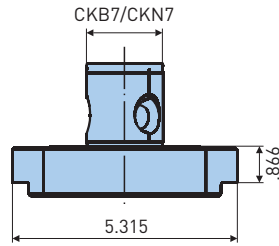
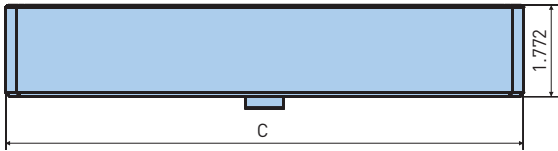

Fig. 3

Catalog Number	Reference Number	Fig.	Weight (lbs.)
CKB7-FL135	10.318.201	2	6.2
CKN7-FL135	10.318.201N		6.1
CKB7-FL135-90	10.318.202	3	6.0
CKN7-FL135-90	10.318.202N		6.0

EXTENSION SLIDES



Catalog Number	Reference Number	C	Boring Range	Max RPM	Weight (lbs.)
SLN200-270AL	10.318.222	7.283	7.87-10.63	3200	3.3
SLN270-340AL	10.318.223	10.039	10.63-13.39	2400	4.5
SLN340-410AL	10.318.224	12.795	13.39-16.14	1900	5.8
SLN410-480AL	10.318.225	15.551	16.14-18.90	1600	7.1
SLN480-550AL	10.318.226	18.307	18.90-21.65	1300	8.6
SLN550-620AL	10.318.227	21.063	21.65-24.41	1200	9.7

CLAMP BASES

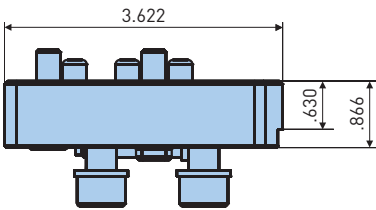

Catalog Number	Reference Number	Type	Weight (lbs.)
CB200E	10.318.250	Inch	3.3
CB200	10.318.240	Metric	

INSERT HOLDERS

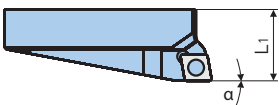

Catalog Number	Reference Number	L1	Angle α	Insert	Weight (lbs.)
IHTW200C	10.637.940	1.339	0°	CC12	1.6
IHTW200C16	10.637.941			CC16	
IHTW200S	10.637.942	1.354	6°	SC12	1.7
IHTW200C-DVS	10.637.951		0°	CC12	.8
IHTW200C16-DVS	10.637.953			CC16	

• DVS insert holders sold individually

ACCESSORIES



ROUGH BORING COMPONENT SELECTION

The table below determines the components such as extension slide (1), clamp bases (2) and insert holders (3) for each diameter range ($\varnothing D$) and shows in which position (1 or 2) the clamp bases (2) have to be mounted on the extension slide (1). Further, this table also serves for the coarse diameter setting of the cutting edges by means of the scale on the clamp base (2) and the marking (4) on the insert holder (3). The required scale value is calculated by the difference between bore diameter and correction value (α). The insert holder has to be adjusted to the scale value. See example below.

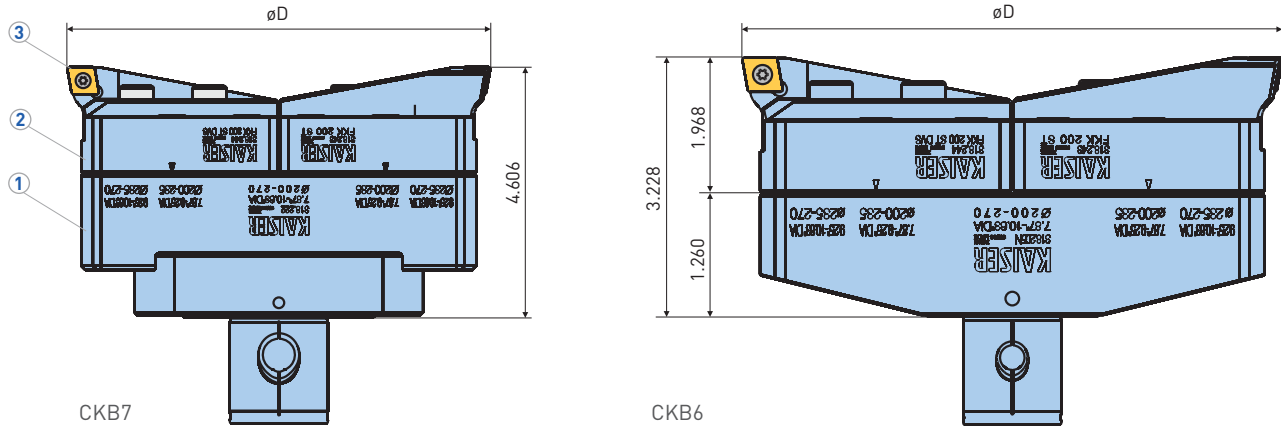

$\varnothing D$	Position	Scale Factor α	Extension Slides (1)	Clamp Bases (2)	Insert Holders (3)
7.756-9.252	1	7.874	10.318.222/10.318.205	10.318.250 (Inch) 10.318.240 (Metric)	10.637.9xx (See Below)
9.134-10.630	2	9.252			
10.512-12.008	1	10.630	10.318.223/10.318.206		
11.890-13.386	2	12.008	10.318.224		
13.268-14.764	1	13.386			
14.646-16.142	2	14.764	10.318.225		
16.024-17.520	1	16.142			
17.402-18.898	2	17.520	10.318.226		
18.780-20.276	1	18.898			
20.157-21.654	2	20.276	10.318.227		
21.535-23.031	1	21.654			
22.913-24.409	2	23.031			

Example: Diameter Setting According to Scale

$\varnothing D$: 18.020

Extension Slide: 10.318.225

Position: 1

Correction Value α : 17.520

Scale Value: $\varnothing D - \alpha = 18.020 - 17.520 = .500$

ACCESSORIES



INSERT HOLDERS FOR CHAMFERING

The insert holder with step-less adjustable chamfer angle from 15-75° is made for front chamfering and with limitations also for back chamfering.



Catalog Number	Reference Number
CFW200S	10.637.959

Extension Slide	15°	30°	45°	60°	75°
SLN200-270AL	7.165-10.866	7.323-10.945	7.480-10.984	7.677-10.945	7.835-10.906
SLN270-340AL	9.921-13.622	10.079-13.701	10.236-13.740	10.433-13.701	10.591-13.661
SLN340-410AL	12.677-16.378	12.835-16.457	12.992-16.496	13.189-16.457	13.346-16.417
SLN410-480AL	15.433-19.134	15.591-19.213	15.748-19.252	15.945-19.213	16.102-19.173
SLN480-550AL	18.189-21.890	18.346-21.969	18.504-22.008	18.701-21.969	18.858-21.929
SLN550-620AL	20.945-24.646	21.102-24.724	21.260-24.764	21.457-24.724	21.614-24.685

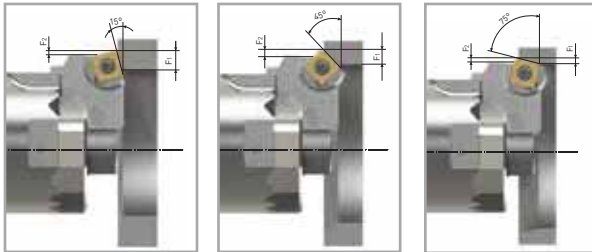

Radial Chamfer Length									
15°		30°		45°		60°		75°	
F1	F2	F1	F2	F1	F2	F1	F2	F1	F2
.449	.118	.406	.157	.331	.165	.232	.154	.118	.118

FACE GROOVING HOLDERS



Catalog Number	Reference Number	øD
FGHTW200	10.637.961	7.795-118

ACCESSORIES

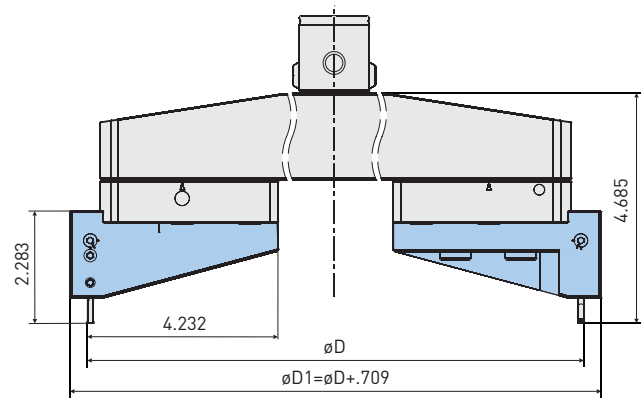

• For diameter range D please see page 481

CUTTERS

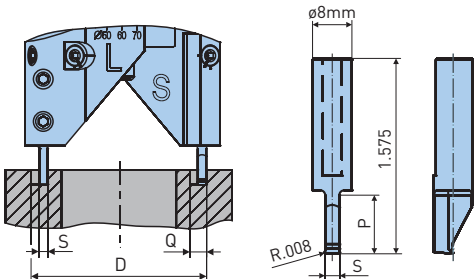

*Application
AL = Aluminium

ST = Steel
GG = Cast iron

Catalog Number	Reference Number	Cutter	Cutter Width S	Max. Groove Width Q	Max. Groove Depth P
FG2-ST8-40K40	10.958.601	Uncoated K40/AL	.079	.138	.472
FG3-ST8-40K40	10.958.602		.118	.217	
FG4-ST8-40K40	10.958.603		.157	.295	
FG5-ST8-40K40	10.958.604		.197	.374	
FG2-ST8-40K40C	10.958.611	Coated P40C/ST, CI	.079	.138	
FG3-ST8-40K40C	10.958.612		.118	.217	
FG4-ST8-40K40C	10.958.613		.157	.295	
FG5-ST8-40K40C	10.958.614		.197	.374	

• For diameter range D please see page 481

EWN/EWE FINE BORING HEADS RANGE: $\phi 7.87''$ - $118.1''$

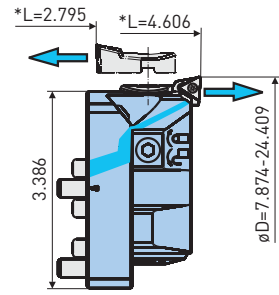

Catalog Number	Reference Number	Units	Resolution	Weight (lbs.)
EWE200E-AL	10.318.114	Inch	.00005/ ϕ	1.8
EWN200E-AL	10.318.111	Inch	.0005/ ϕ	

*Please see page 485

INSERT HOLDERS

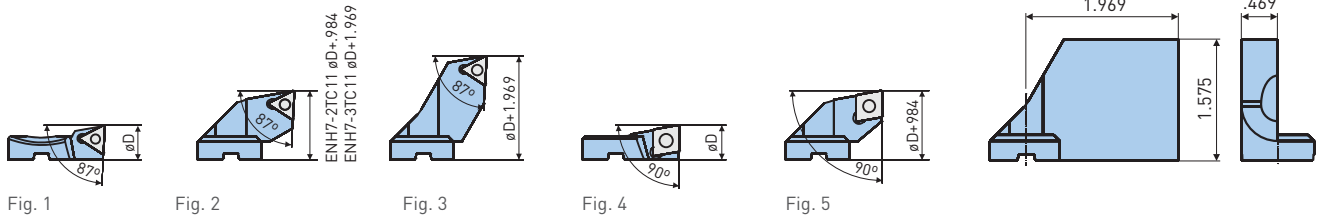

Catalog Number	ENH7-1TC11	ENH7-2TC11	ENH7-3TC11	ENH7-1CC09	ENH7-2CC09
Reference Number	10.626.271	10.626.272	10.626.273	10.626.371	10.626.372
Fig.	1	2	3	4	5
Insert	TC11			CC09	

ACCESSORIES



• For diameter range D please see page 485

INSERT HOLDERS FOR CHAMFERING AND UNDERCUTS

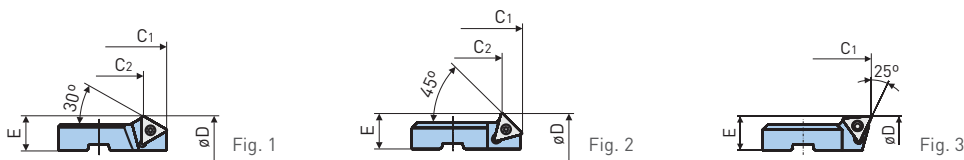

Catalog Number	Reference Number	Fig.	Angle	C1	C2	E	Insert
ENH7-1T30	10.626.472	1	30°	4.606	4.264	.492	TC11
ENH7-1T45	10.626.473	2	45°		4.323		
ENH7-1T25	10.689.189	3	25°		—		

ACCESSORIES



- Min. diameter for back boring/back chamfering= ϕD min. [of the respective boring range]+.472.
- Example for the lowest range: Min. diameter= $7.835+.472=8.307$
- For diameter range D please see page 485

COUNTER WEIGHTS

There are two different counter weights available. Type 1 is made of steel and is used for coarse balancing. Type 2 is made of aluminum and contains a slide with a graduated scale for fine balancing of the tool assembly.

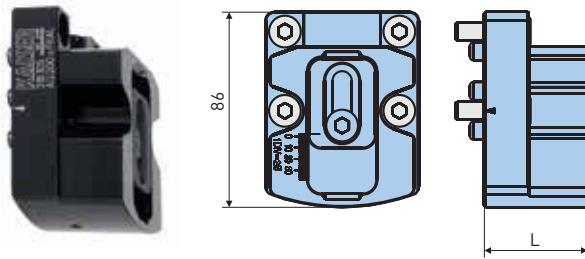

Catalog Number	Reference Number	Weight (lbs.)
CW200E-AL	10.318.115 (Inch)	1.9
CW200	10.318.107 (Fixed)	1.8

ACCESSORIES



COOLANT PIPE

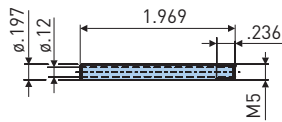

Catalog Number	Reference Number
CP-DM5-50-M5	10.692.415

FINE BORING COMPONENT SELECTION

The table below determines the components such as extension slide (1), boring head (2), insert holder (3) and counter weight (4) for each diameter range and shows in which position the boring head and the counter weight have to be mounted on the extension slide. Balancing of the tool combination takes place by adjusting the slide (5) on the counter weight according to the scale. The correction value (α) is shown on the table. See example below.

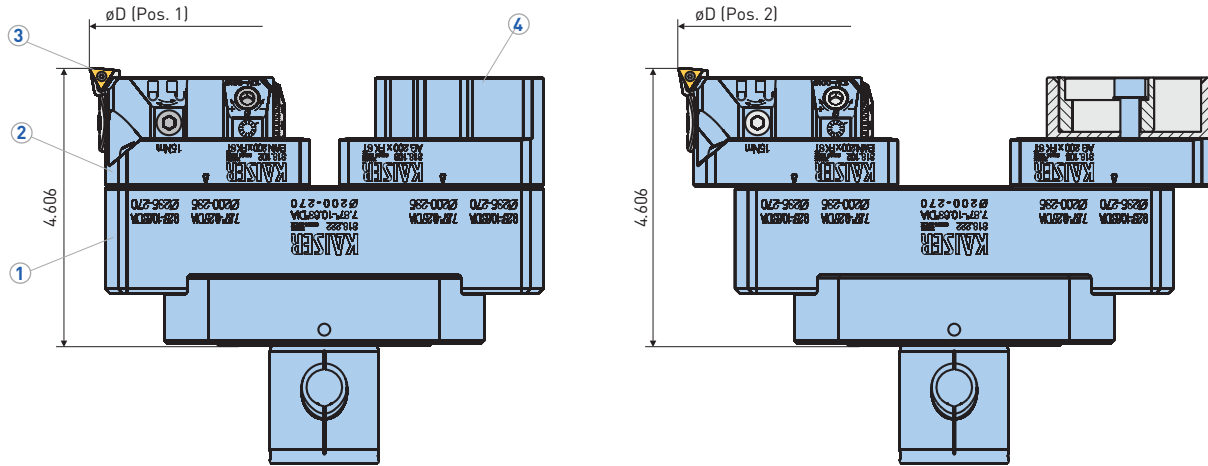

øD	Position	Balance Factor	Extension Slides (1)	Boring Head (2)	Insert Holders (3)	Counterweights (4)
7.795-9.331	1	7.874	10.318.222 10.318.205N	10.318.111 (See Also Pg. 483)	10.626.271 (TC11) or 10.626.371 (CC09)	10.318.107 (Fixed) 10.318.115 (Inch)
9.173-10.709	2	9.252				
10.551-12.087	1	10.630	10.318.223 10.318.206N			
11.929-13.465	2	12.008				
13.307-14.843	1	13.386	10.318.224			
14.685-16.220	2	14.764				
16.063-17.598	1	16.142	10.318.225			
17.441-18.976	2	17.520				
18.819-20.354	1	18.898	10.318.226			
20.197-21.732	2	20.276				
21.575-23.110	1	21.654	10.318.227			
22.953-24.488	2	23.031				

Example: Diameter Setting According to Scale
 øD: 18.880
 Extension Slide: 10.318.223

Position: 1
 Correction Value α : 10.630

Scale Value: $\alpha D = 18.880 - 10.630 = .250$

O.D. TURNING MODULAR SLIDES & ADAPTERS FOR ROUGH PIN TURNING LARGE DIAMETERS

RANGE: \varnothing 2.283"-18.740"

The turning adapter with KA5 connection can be mounted on a variety of extension slides to create your diameter. For rough pin turning, it is required to connect two TWN 315 x KA5 either directly to the turning adapter or by means of an extension to the adapter.



Insert Holder & Ranges (5)		Assembly Position	Extension Slide (1)	Turning Adapter (2)	Boring Head (4)
10.638.452	10.638.451				
2.283-2.953	2.913-3.583	1	10.318.222	CB200CK5 (10.318.261) 2 Req'd	TWN53-86CKB5 (10.315.501) 2 Req'd
3.661-4.331	4.291-4.961	2			
5.039-5.709	5.669-6.339	1	10.318.223		
6.417-7.087	7.047-7.717	2			
7.795-8.465	8.425-9.094	1	10.318.224		
9.173-9.843	9.803-10.472	2			
10.551-11.220	11.181-11.850	1	10.318.225		
11.929-12.598	12.559-13.228	2			
13.307-13.976	13.937-14.606	1	10.318.226		
14.685-15.354	15.315-15.984	2			
16.063-16.732	16.693-17.362	1	10.318.227		
17.441-18.110	18.071-18.740	2			

CAUTION

Counter-clockwise spindle rotation required.

ACCESSORIES



O.D. TURNING MODULAR SLIDES & ADAPTERS FOR FINISH PIN TURNING LARGE DIAMETERS

RANGE: $\phi 1.929''$ -18.740''

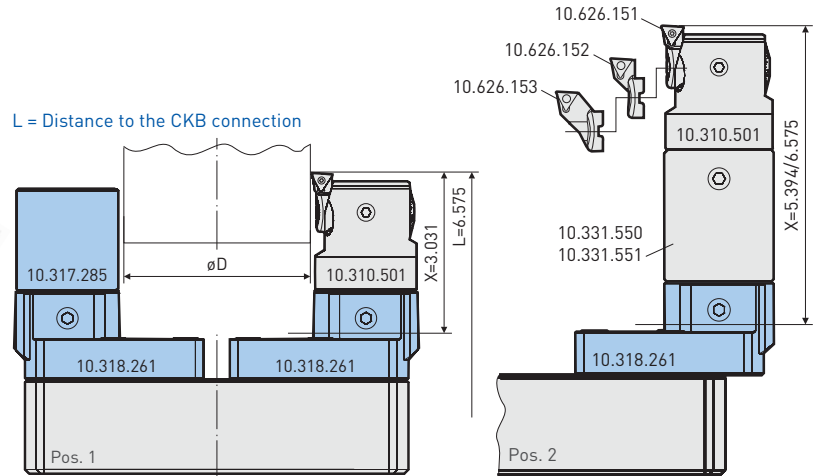

TOOL HOLDER

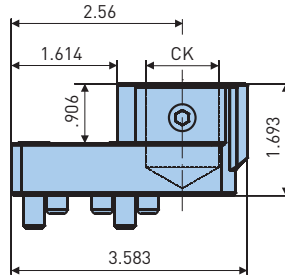

COUNTER WEIGHT

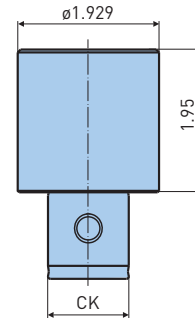

Catalog Number	Reference Number	CK	Weight (lbs.)
CB200CKB5	10.318.261	CKB5	2.7

Catalog Number	Reference Number	CK	Weight (lbs.)
CW-CK5-DM49-50	10.317.285	CK5	1.9

ADJUSTING TABLE

TC..11 Insert Holders & Ranges			Position	Extension Slides	Turning Adapter	Counterweight	Boring Head
10.626.153	10.626.152	10.626.151					
1.929-2.598	2.441-3.110	2.913-3.583	1	SLN200-270AL (10.318.222)	CB200CKB5 (10.318.261) 2 Req'd	CW-CK5-DM49-50 (10.317.285)	EWN53E-CKB5 (10.310.511)
3.307-3.976	3.819-4.488	4.291-4.961	2				
4.685-5.354	5.197-5.866	5.669-6.339	1	SLN270-340AL (10.318.223)			
6.063-6.732	6.575-7.244	7.047-7.717	2				
7.441-8.110	7.953-8.622	8.425-9.094	1	SLN340-410AL (10.318.224)			
8.819-9.488	9.331-10.000	9.803-10.472	2				
10.197-10.866	10.709-11.378	11.181-11.850	1	SLN410-480AL (10.318.225)			
11.575-12.244	12.087-12.756	12.559-13.228	2				
12.953-13.622	13.465-14.134	13.937-14.606	1	SLN480-550AL (10.318.226)			
14.331-15.000	14.843-15.512	15.315-15.984	2				
15.709-16.378	16.220-16.890	16.693-17.362	1	SLN550-620AL (10.318.227)			
17.087-17.756	17.598-18.268	18.071-18.740	2				

CAUTION

Counter-clockwise spindle rotation required.

ACCESSORIES

 FLANGE ADAPTERS PG. 480	 EXTENSION SLIDES PG. 480
--------------------------------	---------------------------------

SERIES 318 WITH BRIDGE AND EXTENSION SLIDES

The boring range from $\phi 24.41$ -118.10 is covered with only five aluminium bridges and five pairs of extension slides. All other components such as boring head, clamp bases and insert holders are the same as for the existing light weight boring tool system $\phi 7.87$ -24.41.

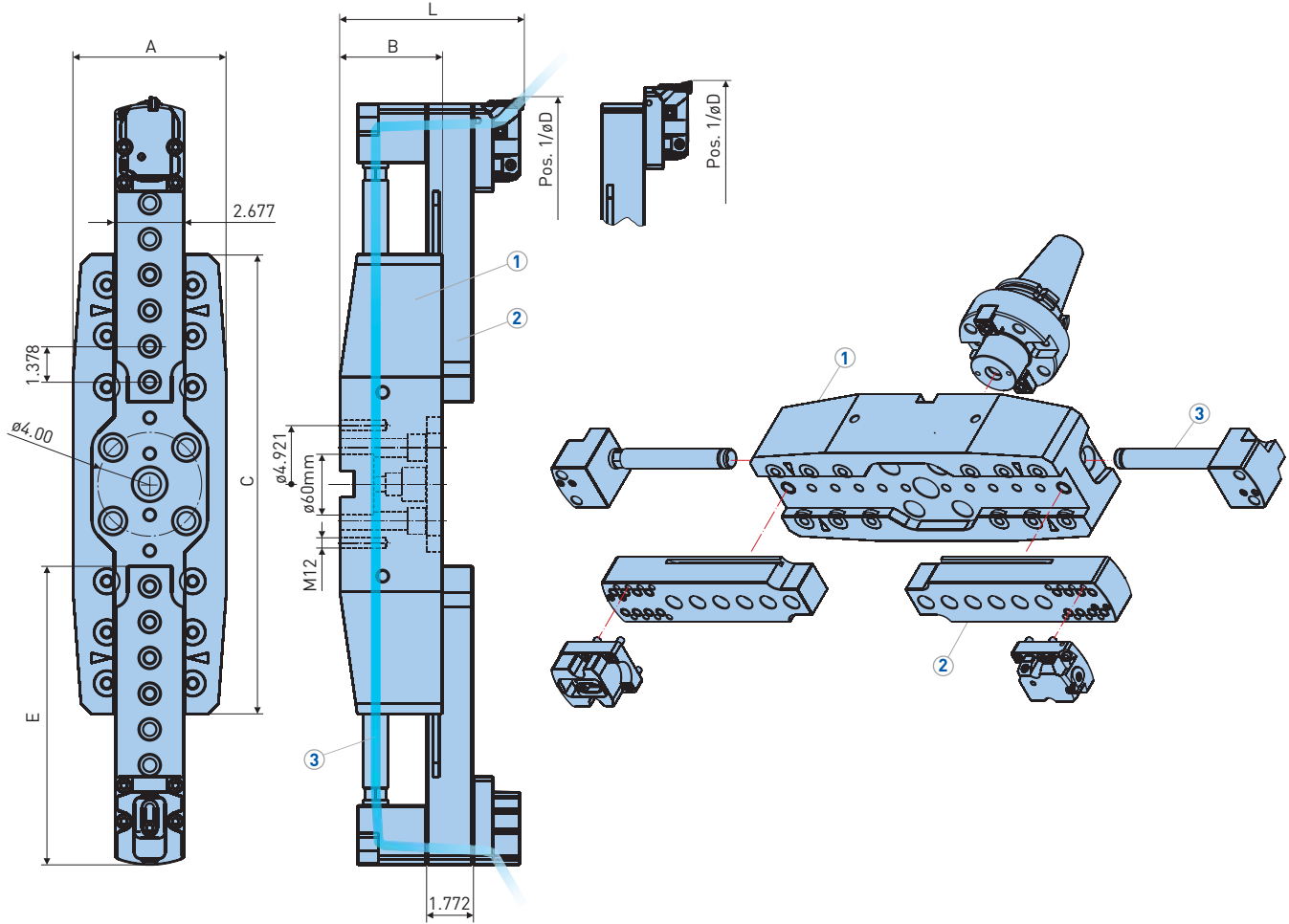

ϕD	Bridge (1)	Reference Number	L	A	B	C	E	Weight (lbs.)
24.409-32.677	BR620-830	10.318.421	7.087	5.906	3.937	17.717	11.516	32.0
32.677-43.701	BR830-1110	10.318.422	7.087	5.906	3.937	25.984	15.650	47.0
43.701-60.236	BR1110-1530	10.318.423				37.008	21.161	73.0
60.236-79.528	BR1530-2020	10.318.424	7.874	6.693	4.724	53.543	25.295	121.0
79.528-98.819	BR2020-3000	10.318.425	8.268	7.480	5.118	72.835	25.295	198.0
98.819-118.11		10.318.425					45.965	

Extension Slide (2)	Wight (lbs.)
SL620-830	4.6
SL830-1110	6.4
SL1110-1530	6.6
SL1530-2020	7.5
SL2510-3000	8.8

Coolant Pipe (3)	Wight (lbs.)
CS620-830	2.8
CS1110-1530	3.3
CS2020-2510	3.3
CS2510-3000	3.3

ACCESSORIES



ROUGH AND FINE BORING COMPONENT SELECTION

The table below refers to the drawings on Pg. 488. It determines the components such as bridge (1), extension slide (2) and coolant supply (3) for each diameter range (øD) and shows in which position (1 or 2) the roughing or finishing tools have to be mounted.

Boring Range øD		Bridge		Extension Slide*		Coolant Pipe*	
Position 1	Position 2	Catalog Number	Reference Number	Catalog Number	Reference Number	Catalog Number	Reference Number
24.37-25.83	25.75-27.20	BR620-830	10.318.421	SL620-830	10.318.431	CS620-830	10.318.441
27.13-28.58	28.50-29.96						
29.8 -31.34	31.26-32.72						
32.64-34.09	34.02-35.47	BR830-1110	10.318.422	SL830-1110	10.318.432	CS620-830	10.318.441
35.39-36.85	36.77-38.23						
38.15-39.61	39.53-40.98						
40.91-42.36	42.28-43.74						
43.66-45.12	45.04-46.50	BR1110-1530	10.318.423	SL1110-1530	10.318.433	CS1110-1530	10.318.442
46.42-47.87	47.80-49.25						
49.17-50.63	50.55 -52.01						
51.93-53.39	53.31-54.76						
54.69-56.14	56.06-57.52						
57.44-58.90	58.82-60.28						
60.20-61.65	61.57-63.03	BR1530-2020	10.318.424	SL1530-2020	10.318.434	CS2020-2510	10.318.443
62.95-64.41	64.33-65.79						
65.71-67.17	67.09-68.54						
68.46-69.92	69.84-71.30						
71.22-72.68	72.60-74.06						
73.98-75.43	75.35-76.81						
76.73-78.19	78.11-79.57						
79.49-80.94	80.87-82.32	BR2020-2510	10.318.425	SL1530-2020	10.318.434	CS2020-2510	10.318.443
82.24-83.70	83.62-85.08						
85.00-86.46	86.38-87.83						
87.76-89.21	89.13-90.59						
90.51-91.97	91.89-93.35						
93.27-94.72	94.65-96.10						
96.02-97.48	97.40-98.86						
98.78-100.24	100.16-101.61	BR2510-3000	10.318.425	SL2510-3000	10.318.435	CS2510-3000	10.318.444
101.54-102.99	102.91-104.37						
104.29-105.75	105.67-107.13						
107.05-108.50	108.43-109.88						
109.80-111.26	111.18-112.64						
112.56-114.02	113.94-115.39						
115.31-116.77	116.69-118.15						

*Single pieces

ACCESSORIES



BRIDGE TOOL HOLDER

For X-Large Diameter Pin Turning

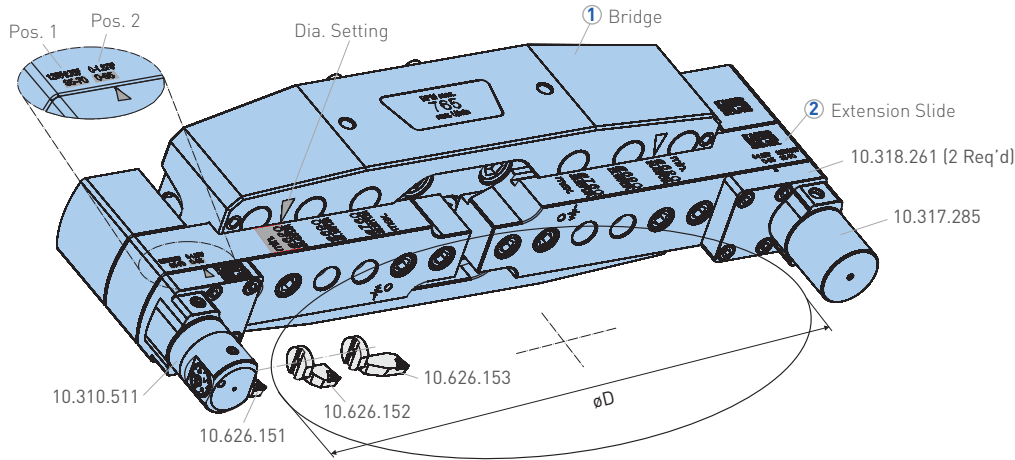

Insert Holder & Turning Range [5 - Position 1]			Insert Holder & Turning Range [5 - Position 2]			Diameter Setting Position	Bridge (1)	Extension Slide (2)
10.626.153	10.626.152	10.626.151	10.626.153	10.626.152	10.626.151			
18.465-19.134	18.976-19.646	19.449-20.118	19.843-20.512	20.354-21.024	20.827-21.496	620	BR620-830 (10.318.421)	SL620-830 (10.318.431)
21.220-21.890	21.732-22.402	22.205-22.874	22.598-23.268	23.110-23.780	23.583-24.252	690		
23.976-24.646	24.488-25.157	24.961-25.630	25.354-26.024	25.866-26.535	26.339-27.008	760		
26.732-27.402	27.244-27.913	27.717-28.386	28.110-28.780	28.622-29.291	29.094-29.764	830	BR830-1110 (10.318.422)	SL830-1110 (10.318.432)
29.488-30.157	30.000-30.669	30.472-31.142	30.866-31.535	31.378-32.047	31.850-32.520	900		
32.244-32.913	32.756-33.425	33.228-33.898	33.622-34.291	34.134-34.803	34.606-35.276	970		
35.000-35.669	35.512-36.181	35.984-36.654	36.378-37.047	36.890-37.559	37.362-38.031	1040	BR1110-1530 (10.318.423)	SL1110-1530 (10.318.433)
37.756-38.425	38.268-38.937	38.740-39.409	39.134-39.803	39.646-40.315	40.118-40.787	1110		
40.512-41.181	41.024-41.693	41.496-42.165	41.890-42.559	42.402-43.071	42.874-43.543	1180		
43.268-43.937	43.780-44.449	44.252-44.921	44.646-45.315	45.157-45.827	45.630-46.299	1250	BR1530-2020 (10.318.424)	SL1530-2510 (10.318.434)
46.024-46.693	46.535-47.205	47.008-47.677	47.402-48.071	47.913-48.583	48.386-49.055	1320		
48.780-49.449	49.291-49.961	49.764-50.433	50.157-50.827	50.669-51.339	51.142-51.811	1390		
51.535-52.205	52.047-52.717	52.520-53.189	52.913-53.583	53.42554.094	53.898-54.567	1460		
54.291-54.961	54.803-55.472	55.276-55.945	55.669-56.339	56.181-56.850	56.654-57.323	1530		
57.047-57.717	57.559-58.228	58.031-58.701	58.425-59.094	58.937-59.606	59.409-60.079	1600		
59.803-60.472	60.315-60.984	60.787-61.457	61.181-61.850	61.693-62.362	62.165-62.835	1670		
62.559-63.228	63.071-63.740	63.543-64.213	63.937-64.606	64.449-65.118	64.921-65.591	1740		
65.315-65.984	65.827-66.496	66.299-66.969	66.693-67.362	67.205-67.874	67.677-68.346	1810		
68.071-68.740	68.583-69.252	69.055-69.724	69.449-70.118	69.961-70.630	70.433-71.102	1880		
70.827-71.496	71.339-72.008	71.811-72.480	72.205-72.874	72.717-73.386	73.189-73.858	1950		

Insert Holder & Turning Range [5 - Position 1]			Insert Holder & Turning Range [5 - Position 2]			Diameter Setting Position	Bridge (1)	Extension Slide (2)
10.626.153	10.626.152	10.626.151	10.626.153	10.626.152	10.626.151			
73.583-74.252	74.094-74.764	74.567-75.236	74.961-75.630	75.472-76.142	75.945-76.614	2020	BR2020-3000 (10.318.425)	SL1530-2510 (10.318.434)
76.339-77.008	76.850-77.520	77.323-77.992	77.717-78.386	78.228-78.898	78.701-79.370	2090		
79.094-79.764	79.606-80.276	80.079-80.748	80.472-81.142	80.984-81.654	81.457-82.126	2160		
81.850-82.520	82.362-83.031	82.835-83.504	83.228-83.898	83.740-84.409	84.213-84.882	2230		
84.606-85.276	85.118-85.787	85.591-86.260	85.984-86.654	86.496-87.165	86.969-87.638	2300		
87.362-88.031	87.874-88.543	88.346-89.016	88.740-89.409	89.252-89.921	89.724-90.394	2370		
90.118-90.787	90.630-91.299	91.102-91.772	91.496-92.165	92.008-92.677	92.480-93.150	2440		
92.874-93.543	93.386-94.055	93.858-94.528	94.252-94.921	94.764-95.433	95.236-95.906	2510	BR2020-3000 (10.318.425)	SL2510-3000 (10.318.435)
95.630-96.299	96.142-96.811	96.614-97.283	97.008-97.677	97.520-98.189	97.992-98.661	2580		
98.386-99.055	98.898-99.567	99.370-100.039	99.764-100.433	100.276-100.945	100.748-101.417	2650		
101.142-101.811	101.654-102.323	102.126-102.795	102.520-103.189	103.031-103.701	103.504-104.173	2720		
103.898-104.567	104.409-105.079	104.882-105.551	105.276-105.945	105.787-106.457	106.260-106.929	2790		
106.654-107.323	107.165-107.835	107.638-108.307	108.031-108.701	108.543-109.213	109.016-109.685	2860		
109.409-110.079	109.921-110.591	110.394-111.063	110.787-111.457	111.299-111.969	111.772-112.441	2930		

CAUTION

Counter-clockwise spindle rotation required.

SHANKS FOR SERIES 318

RANGE: $\varnothing 24.37-118.2$

CAT50 BIG-PLUS

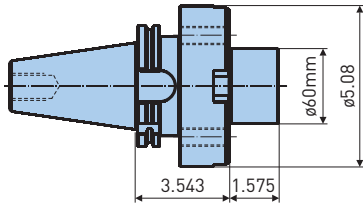

Catalog Number	Weight (lbs.)
BCV50H-FMH60-90	20.9

BT50 BIG-PLUS

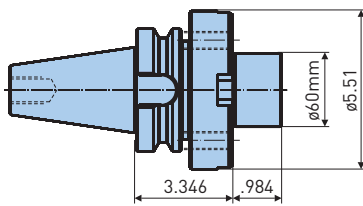

Catalog Number	Weight (lbs.)
BBT50-FMB60-75	16.5

HSK-A100

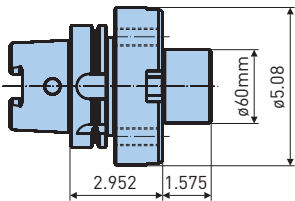

Catalog Number	Weight (lbs.)
HSKA100-F60-75	14.5

BIG KAISER CKN

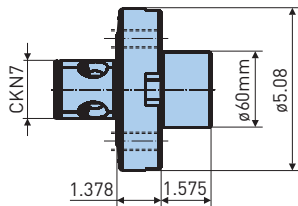

Catalog Number	Reference Number	Weight (lbs.)
CKN7-F60	10.328.217N	10.4

SAFETY INSTRUCTIONS

The max. speed allowed for series 318 boring tools is in relation to the boring diameter and the extension slide used. All extension slides are marked with max. speed allowed [n max.].

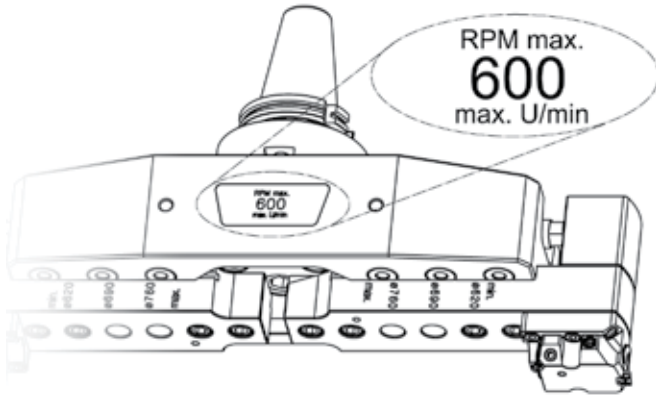

øD	Max Speed (RPM)	Bridge Aluminum	
		Catalog Number	Reference Number
24.37-32.72	600	BR620-830	10.318.421
32.64-43.74	450	BR830-1110	10.318.422
43.66-60.28	350	BR1110-1530	10.318.423
60.20-79.57	250	BR1530-2020	10.318.424
79.49-98.86	190	BR2020-2510	10.318.425
98.78-118.15	150	BR2510-3000	10.318.425

APPLICATION NOTES

ROUGHING

ø24.37-43.70

Up to ø32.68 the bridge tool can be connected to the machine spindle over a tool shank, but only on a machine with good spindle taper, good spindle bearings and with the normal retention force available. For the range between ø32.68-43.70, roughing is possible with the bridge bolted on to the machine spindle. If vibration occurs use just one cutting edge.

ø>43.70

Roughing is not recommended

FINISHING

ø24.37-43.70

Finishing is possible with the bridge tool connected to the machine spindle over a tool shank, providing that the machine spindle is in good condition.

ø>43.70

The bridge tool must be bolted on to the machine spindle, either directly or if required over a special flange.

CONNECTING THE BRIDGE TO THE MACHINE SPINDLE

The bridge tool can be connected to the machine spindle over a tool shank (Fig. 1) or it can be bolted on to the spindle face (Fig. 2). A bolted connection is recommended for bore sizes ø43.70 and bigger.

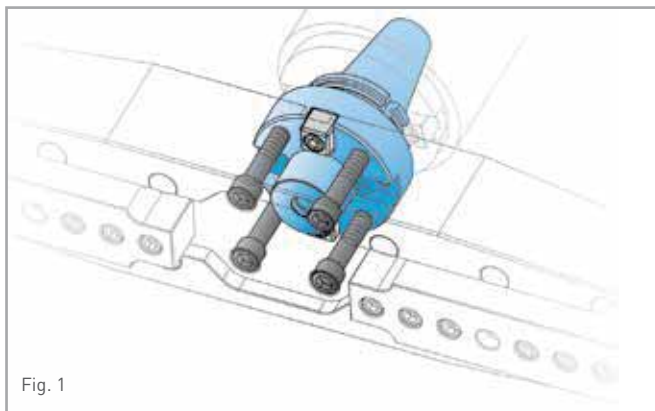

Fig. 1

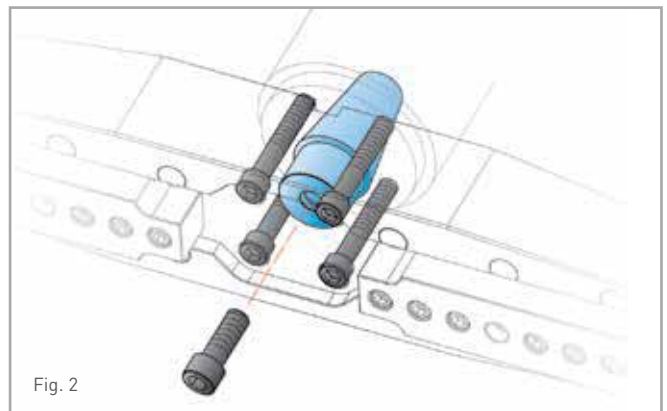

Fig. 2

Series 318 ROUGH BORING INSERT SELECTION & CUTTING DATA

RANGE: ø7.76"-24.41"



Material	Insert Radius	CC..12 [1/2" I.C.]						CC..16 [5/8" I.C.]				SC..12 [1/2" I.C.]			Speed (SFM)
		Catalog Number	Balanced Cutting		Stepped Cutting		Catalog Number	Balanced Cutting		Stepped Cutting		Catalog Number	Balanced Cutting		
			Feed (IPR)	Max ø D.O.C.	Feed (IPR)	Max ø D.O.C.		Feed (IPR)	Max ø D.O.C.	Feed (IPR)	Max ø D.O.C.		Feed (IPR)	Max ø D.O.C.	
Mild Steels 10XX-15XX 1018, 1020, 1551	.016	11.654.993	.014	.350	.008	.600	—	—	—	—	—	11.654.340	.016	.350	400-825
	.031	11.654.990	.020	.400	.012	.800	11.654.996	.024	.600	.014	1.120	11.654.350	.022	.380	
High Carbon Alloy Steels 23XX-92XX 4130, 4340, 8620	.016	11.654.993	.012	.350	.008	.600	—	—	—	—	—	11.654.340	.014	.350	350-750
	.031	11.654.990	.018	.400	.012	.800	11.654.996	.022	.600	.012	1.120	11.654.350	.020	.380	
300 Series Stainless Steel 304, 316, 17-4ph	.016	—	—	—	—	—	—	—	—	—	—	—	—	—	200-450
	.031	11.654.983	.018	.325	.010	.600	10.654.996	.022	.400	.012	.800	11.654.353	.020	.300	
400 Series Stainless Steel Martensitic	.016	11.654.993	.012	.350	.008	.600	—	—	—	—	—	11.654.340	.014	.350	250-550
	.031	11.654.990	.018	.400	.012	.800	10.654.996	.022	.600	.012	1.120	11.654.350	.020	.380	
Grey Cast Iron Class 30	.016	11.654.993	.014	.500	.008	.800	—	—	—	—	—	11.654.340	.016	.480	300-600
	.031	11.654.971	.020	.600	.012	1.000	11.654.971	.024	.750	.014	1.400	11.654.352	.022	.580	
Silicon Nitride	—	11.654.980	.018	.500	.010	.800	—	—	—	—	—	—	—	—	800-1650
Cast Iron Ductile/Nodular	.016	11.654.993	.012	.450	.008	.700	—	—	—	—	—	11.654.340	.014	.420	250-550
	.031	11.654.971	.018	.500	.500	.900	11.654.971	.022	.675	.012	1.250	11.654.352	.020	.480	
High Temp. Alloys Titanium, Inconel, Monel, etc.	.016	—	—	—	—	—	—	—	—	—	—	11.654.344	.010	.200	100-225
	.031	11.654.978	.014	.280	.007	.500	10.654.997	.016	.380	.008	.700	11.654.359	.014	.250	
Copper Alloys Brass & Bronze	.016	11.654.989	.014	.500	.008	.800	—	—	—	—	—	11.654.344	.016	.480	550-800
	.031	11.654.991	.020	.600	.012	1.000	10.654.997	.024	.750	.014	1.400	11.654.359	.022	.580	
Aluminum & Non-Ferrous	.016	10.654.995	.016	.550	.010	1.000	—	—	—	—	—	—	—	—	825-1300
	.031	10.654.992	.022	.650	.012	1.250	10.654.998	.030	.900	.015	1.625	10.654.387	.022	.650	

All cutting data without guarantee

CAUTION

Do not exceed maximum RPM as marked on the extension slide!

Cutting Speed:

$$RPM = \frac{SFM \times 3.82}{Bore \ \phi}$$

Feed Rate:

$$IPM = RPM \times IPR$$

SERIES 318 FINISH BORING INSERT SELECTION & CUTTING DATA

RANGE: $\varnothing 7.795'' - 25.157''$



Material	Insert Radius	Insert Type & Size		Stock Allowance on Dia.	Feed (IPR)	Speed (SFM)
		TC..11	CC..09			
Mild, Low-Carbon Steel 10XX-15XX 1018, 1020, 1551, A36	.016	11.655.322	11.654.959	.016-.020	.0040	600-1100
	.031	11.655.332	11.654.960	.024-.040	.0060	
High Carbon Alloy Steels 23XX-92XX Tool Steel 4140, 4340, 8620	.016	11.655.322	11.654.959	.016-.020	.0040	500-900
	.031	11.655.332	11.654.960	.024-.040	.0060	
300 Series Stainless Steel Austenitic 303, 304, 316, 17-4ph	.016	11.655.322	11.654.959	.016-.020	.0040	400-750
	.031	11.655.332	11.654.960	.024-.040	.0060	
400 Series Stainless Steel Martensitic 403, 410, 416, 430	.016	11.655.322	11.654.959	.016-.020	.0040	450-800
	.031	11.655.332	11.654.960	.024-.040	.0060	
Grey Cast Iron Malleable Class 20, 30	.016	10.655.383	11.654.940	.016-.020	.0040	500-1000
	.031	10.655.393	11.654.952	.024-.050	.0060	
CBN-CH, CBN-CHN	—	11.938.833	11.938.838	.008-.016	.0030	1300-1650
Silicon Nitride Si3N4	.031	—	11.654.951	.016-.026	.0050	1500-2000
Cast Iron Ductile/Nodular/Chilled	.016	10.655.302	11.654.940	.016-.020	.0040	350-600
	.031	10.655.303	11.654.952	.024-.040	.0060	
High Temp. Alloys Titanium, Inconel, Monel, etc.	.016	10.655.389	11.654.968	.012-.016	.0020	200-325
	.031	10.655.399	11.654.969	.018-.032	.0030	
Copper Alloys Brass & Bronze	.016	11.655.325	11.654.957	.016-.020	.0040	900-1400
	.031	11.655.335	11.654.958	.024-.050	.0060	
Aluminum/Magnesium 6061, 7075	.016	10.655.387	10.654.977	.016-.020	.0040	1000-1600
	.031	10.655.397	10.654.987	.024-.040	.0060	
Aluminum/Magnesium 6061, 7075 PCD Inserts	.016	10.938.841	11.938.843	.016-.020	.0040	1500-3000
	.031	11.938.860	11.938.851	.024-.050	.0060	
Hardened Steel Min. 50HRc CBN Inserts	.016	10.938.834	11.938.838	.005-.010	.0015	200-300
	.031	10.938.865	—	.006-.012	.0020	

All cutting data without guarantee

CAUTION

Do not exceed maximum RPM as marked on the extension slide!

Cutting Speed:

$$RPM = \frac{SFM \times 3.82}{Bore \varnothing}$$

Feed Rate:

$$IPM = RPM \times IPR$$

SPARE PARTS

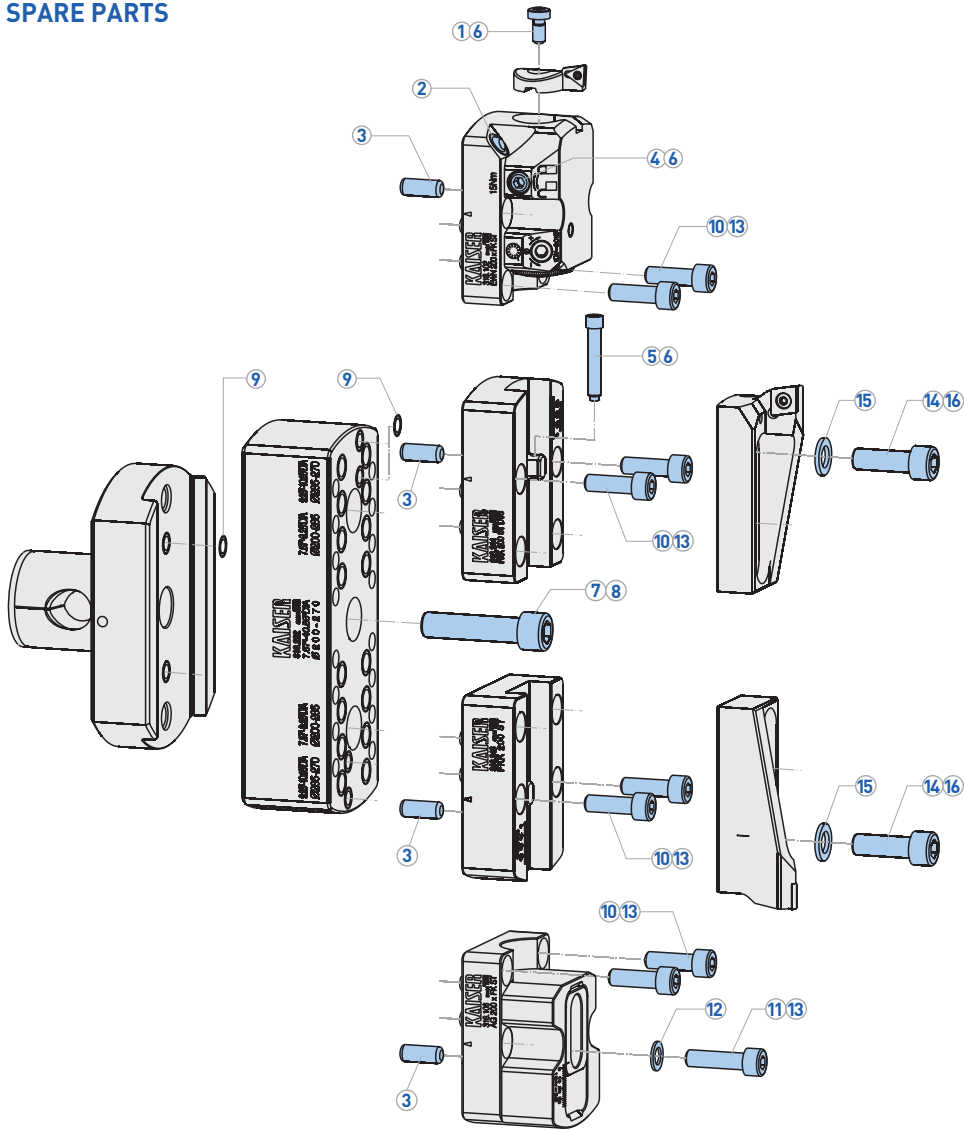

1 10.690.140
Torque: 11 ft-lbs.



5 10.317.193



9 10.692.295



13 10.690.817



2 10.692.406



6 10.690.816



10 10.690.163
Torque: 18 ft-lbs.



14 10.690.105
Torque: 30 ft-lbs.



3 10.691.390



7 10.690.121
Torque: 88 ft-lbs.



11 10.690.124
Torque: 18 ft-lbs.



15 10.693.184



4 10.690.553
Torque: 11 ft-lbs.



8 10.690.134



12 10.693.183



16 10.690.807

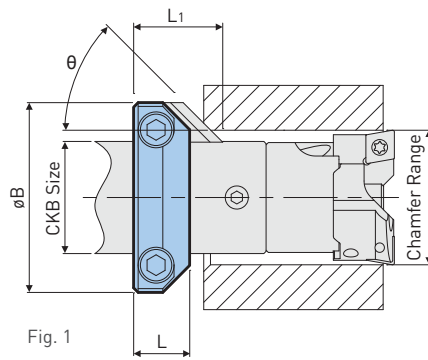

Fig. 1

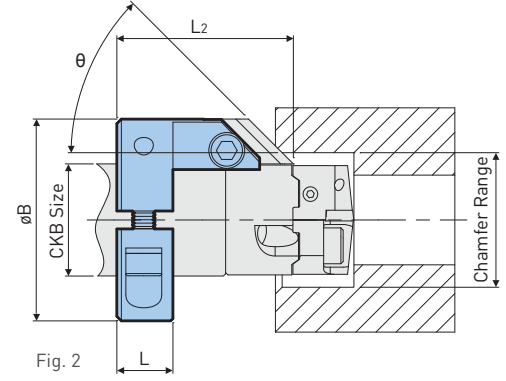
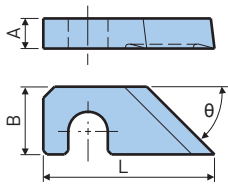

Fig. 2

Adapter Size	Chamfer Range	Fig. 1		Fig. 2		θ	L1	L2	L	øB	Insert Size
		Catalog Number	Reference Number	Catalog Number	Reference Number						
CKB1	.79-1.38	CR20	10.663.110	—	—	30°	1.083	—	.511	1.378	1
						45°	.925	—			
CKB2	.98-1.57	CR25	10.663.120	CR25S	10.663.121	30°	1.083	2.146	.590	1.654	
						45°	.925	1.988			
CKB3	1.26-1.85	CR32	10.663.130	CR32S	10.663.131	30°	1.083	2.322	.590	2.008	
						45°	.925	2.165			
CKB4	1.61-2.17	CR41	10.663.140	CR41S	10.663.141	30°	1.083	2.600	.590	2.244	
						45°	.925	2.441			
CKB5	2.09-3.54	CR53	10.663.150	CR53S	10.663.151	30°	2.047	3.582	.984	3.543	2
						45°	1.693	3.228			
CKB6	2.68-4.09	CR68	10.663.160	CR68S	10.663.161	30°	2.047	4.134	.984	4.094	
						45°	1.693	3.780			

CHAMFER RING INSERTS



Insert Size	θ	Catalog Number	Reference Number	A	B	L
1	30°	CRP20-30	10.663.181	.157	.354	1.083
	45°	CRP20-45	10.663.191			.925
2	30°	CRP53-30	10.663.185	.315	.787	2.047
	45°	CRP53-45	10.663.195			1.693

INDEXABLE INSERTS

For different work piece materials and a quick change of the insert.



Fig. 1



Fig. 2

Insert Size	θ	Catalog Number	Fig	Ring Model	Bore Range		Insert
					Min	Max	
2	45°	CB2-45CW12A	1	CR53	2.165	2.953	CW1206A
				CR68	2.717	3.504	
		CB2-45CW12B	2	CR53	2.756	3.543	
				CR68	3.307	4.134	

- A wrench and screw are included. Inserts to be ordered separately

BIG KAISER SPECIAL TOOLS

You need an insert holder or a shank in a special execution for your BIG KAISER boring head? No problem: BIG KAISER will quickly and professionally deal with your request.



01. REQUEST

Our in-house sales department will process your requests immediately.

02. DEVELOPMENT

Immediately after we have confirmed your purchase order, our developers of the special tool department will take care of your order.

03. PRODUCTION

The professional manufacturing of your special tools is guaranteed.

04. DELIVERY

The tools will be shipped within 8 weeks after receiving purchase order. Our in-house sales department will service you from the request to the delivery.

INSERT HOLDERS



- Roughing with free insert selection for the SW twin-cutter boring heads
- Insert holder in any shape and size for the EWN/EWD precision boring heads
- For contouring, chamfering or pin turning

TOOLS FOR SEVERAL DIAMETERS



- Roughing tool with fixed insert pockets and cartridges. Thanks to CKB connection, the tool is independent of a spindle system
- Finishing tool with BIG KAISER adjustment cartridges
Adjustment precision: $.0005''/\varnothing$

SPECIAL TOOL ACCESSORIES

Cartridges with Micrometer Adjustment for Special, Multi-Diameter Solutions

Special tools with the requirement of high precision adjustment cartridges can be easily designed and manufactured. Five cartridges, offered with either inch ($\phi.0005''/\text{div.}$) or metric ($\phi.01\text{mm}/\text{div.}$) graduated dials cover the diameter work range from $\phi.906''\text{-}4.216''$ ($\phi 23\text{mm}\text{-}107\text{mm}$) by application of two different insert holders.

Cartridges are made with a highly accurate and ground micrometer spindle and tool carrier locking system which will not change diameter setting. Cartridges easily assemble into a precision bore and lock securely into place with a threaded locating screw. The locking screw for the tool carrier is an integral part of the locating screw.

Two insert holders for each cartridge are offered and use ISO standard type inserts. Insert holders can be assembled for either forward or back boring without rotating the cartridges. A grease fitting is also provided to ensure long lasting and accurate diameter setting.

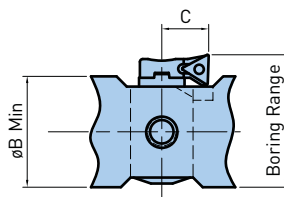

INCH CARTRIDGES, 1 Div = .0005''/ø, ø.906''-4.216''

Type	Catalog Number	øB Min	C	Boring Range	Insert Holder	Insert Type
1/1	10.456.011	.827	.433	.906-1.142	10.626.111	TP..07
				1.102-1.339	10.626.112	TP..07
1/2	10.456.012	1.102	.433	1.299-1.654	10.626.111	TP..07
				1.496-1.811	10.626.112	TP..07
2/1	10.456.013	1.535	.650	1.772 - 2.283	10.626.141	TC..11
				2.126 - 2.638	10.626.142	TC..11
2/2	10.456.014	2.362	.650	2.559 - 3.071	10.626.141	TC..11
				2.913 - 3.425	10.626.142	TC..11
2/3	10.456.015	3.150	.650	3.346 - 3.858	10.626.141	TC..11
				3.701 - 4.216	10.626.142	TC..11

ADJUSTABLE SHELF MOUNT CARTRIDGES—TYPE “ASM”

Radial and axial adjustment cartridges allow quick and easy insert adjustments for diameter and length. Especially suitable for use on special multiple diameter roughing and finish boring tools where the highest cutting capacity at high speed and feed can be realized.

The compact design features a unique pivot pin which maintains line contact to the boring bar pocket at all times through the entire range of travel. Adjustments are easily made by turning the screw conveniently located on the front face of the cartridge. Each cartridge can be adjusted in either direction (radially or axially) by up to .024”.

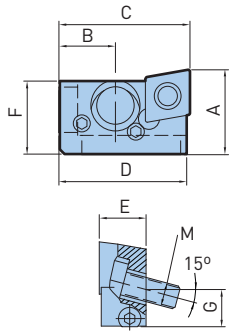

CC..90°

Insert Size	Min. Bore	Catalog Number	A*	B	C	D	E	F	G	M	Gage Insert
CC..06 (1/4" I.C.)	1.260 (32mm)	11.382.316	.512 (13mm)	.335 (8.5mm)	.787 (20mm)	.768 (19.5mm)	.315 (8mm)	.457 (11.6mm)	.225 (5.7mm)	M3x.5	CC..060202
CC..09 (3/8" I.C.)	1.570 (40mm)	11.382.326	.709 (18mm)	.472 (12mm)	1.102 (28mm)	1.075 (27.3mm)	.394 (10mm)	.614 (15.6mm)	.323 (8.2mm)	M5x.8	CC..09T304
CC..12 (1/2" I.C.)	1.970 (50mm)	11.382.346	.866 (22mm)	.472 (12mm)	1.22 (31mm)	1.189 (30.2mm)	.472 (12mm)	.751 (19mm)	.422 (10.7mm)	M6x1	CC..120408
CC..16 (5/8" I.C.)	2.205 (56mm)	11.382.356	1.102 (28mm)	.591 (15mm)	1.496 (38mm)	1.476 (37.5mm)	.472 (12mm)	.992 (25.2mm)	.512 (13mm)	M6x1	CC..160508

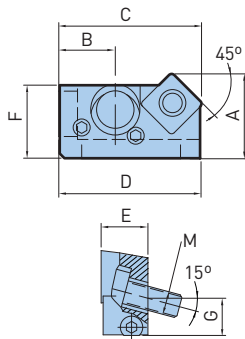

SC..45°

Insert Size	Min. Bore	Catalog Number	A*	B	C*	D	E	F	G	M	Gage Insert
SC..09 (3/8" I.C.)	1.570 (40mm)	11.382.223	.709 (18mm)	.472 (12mm)	1.200 (30.5mm)	1.173 (29.8mm)	.394 (10mm)	.622 (15.8mm)	.323 (8.2mm)	M5x.8	SC..09T304

SC..30°

Insert Size	Min. Bore	Catalog Number	A*	B	C*	D	E	F	G	M	Gage Insert
SC..09 (3/8" I.C.)	1.570 (40mm)	11.382.224	.709 (18mm)	.472 (12mm)	1.200 (30.5mm)	1.173 (29.8mm)	.394 (10mm)	.622 (15.8mm)	.323 (8.2mm)	M5x.8	SC..09T304
SC..12 (1/2" I.C.)	1.970 (50mm)	11.382.244	1.024 (26mm)	.472 (12mm)	1.378 (35mm)	1.366 (34.7mm)	.472 (12mm)	.835 (21.2mm)	.500 (12.7mm)	M6x1	SC..120408

RC

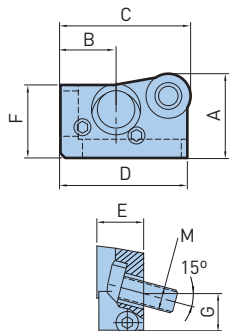

Insert Size	Min. Bore	Catalog Number	A	B	C	D	E	F	G	M	Gage Insert
RC..12 (1/2" I.C.)	1.970 (50mm)	11.382.366	.866 (22mm)	.472 (12mm)	1.220 (31mm)	1.189 (30.2mm)	.472 (12mm)	.751 (19mm)	.422 (10.7mm)	M6x1	RC..120400

*Dimensions based on .016" nose radius for 1/4" & 3/8" I.C. inserts; 1/2" & 5/8" I.C. insert cartridges based on .031" nose radius

FIXED SHELF MOUNT CARTRIDGES—TYPE “FSM” & “TSM”

These compact and rigid insert cartridges are best utilized for special multi-diameter roughing and chamfering tools. Combined with other KAISER boring tool components, they can optimize high production boring, facing, or chamfering. Other typical applications are for dedicated core drilling/rough boring operations requiring fixed diameter and length.

TYPE “FSM”—.030” (.8mm) Adjustment with Shim

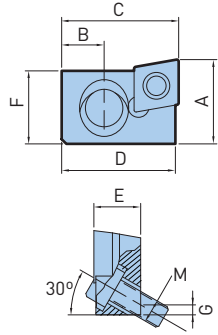

CC..90°

Insert Size	Min Bore	Catalog Number	A*	B	C	D	E	F	G	M	Gage Insert
CC..06 (1/4" I.C.)	1.260 (32mm)	11.381.316	.433 (11mm)	.276 (7mm)	.787 (20mm)	.768 (19.5mm)	.315 (8mm)	.377 (9.6mm)	.035 (.9mm)	M3x.5	CC..060202
CC..09 (3/8" I.C.)	1.570 (40mm)	11.381.326	.670 (17mm)	.295 (7.5mm)	.984 (25mm)	.961 (24.4mm)	.394 (10mm)	.583 (14.8mm)	.084 (2.1mm)	M5x.8	CC..09T304
CC..12 (1/2" I.C.)	1.89 (48mm)	11.381.346	.866 (22mm)	.315 (8mm)	1.181 (30mm)	1.154 (29.3mm)	.472 (12mm)	.751 (19mm)	.151 (3.8mm)	M6x1	CC..120408

SC..45°

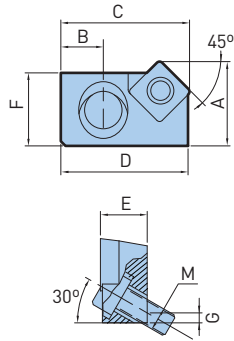

Insert Size	Min Bore	Catalog Number	A*	B	C*	D	E	F	G	M	Gage Insert
SC..09 (3/8" I.C.)	1.570 (40mm)	11.381.223	.670 (17mm)	.295 (7.5mm)	1.023 (26mm)	1.000 (25.4mm)	.394 (10mm)	.583 (14.8mm)	.084 (2.1mm)	M5x.8	SC..09T304
SC..12 (1/2" I.C.)	1.890 (48mm)	11.381.243	.866 (22mm)	.315 (8mm)	1.260 (32mm)	1.232 (31.3mm)	.472 (12mm)	.751 (19mm)	.151 (3.8mm)	M6x1	SC..120408

SC..30°

Insert Size	Min Bore	Catalog Number	A*	B	C*	D	E	F	G	M	Gage Insert
SC..09 (3/8" I.C.)	1.570 (40mm)	11.381.224	.670 (17mm)	.295 (7.5mm)	1.023 (26mm)	1.000 (25.4mm)	.394 (10mm)	.583 (14.8mm)	.084 (2.1mm)	M5x.8	SC..09T304
SC..12 (1/2" I.C.)	1.890 (48mm)	11.381.244	.866 (22mm)	.315 (8mm)	1.260 (32mm)	1.232 (31.3mm)	.472 (12mm)	.751 (19mm)	.151 (3.8mm)	M6x1	SC..120408

TYPE “TSM”—No Adjustment

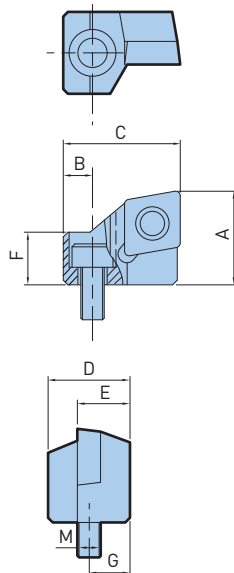

CC..90°

Insert Size	Min Bore	Catalog Number	A*	B	C	D	E	F	G	M	Gage Insert
CC..06 (1/4" I.C.)	1.181 (30mm)	11.381.416	.394 (10mm)	.157 (4mm)	.591 (15mm)	.394 (10mm)	.276 (7mm)	.197 (5mm)	.197 (5mm)	M3x.5	CC..060204
CC..09 (3/8" I.C.)	1.496 (38mm)	11.381.426	.630 (16mm)	.197 (5mm)	.787 (20mm)	.551 (14mm)	.354 (9mm)	.354 (9mm)	.276 (7mm)	M4x.7	CC..09T308
CC..12 (1/2" I.C.)	1.890 (48mm)	11.381.446	.787 (20mm)	.236 (6mm)	.984 (25mm)	.630 (16mm)	.394 (10mm)	.472 (12mm)	.315 (8mm)	M6x1	CC..120408

*Dimensions based on .016" nose radius for 1/4" & 3/8" I.C. inserts; 1/2" I.C. insert cartridges based on .031" nose radius

MT—CKB SHANKS

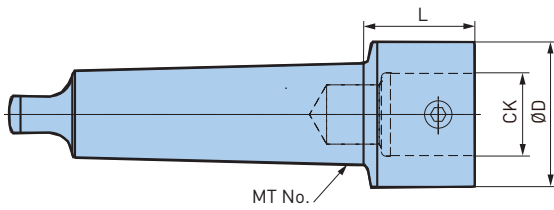

Catalog Number	CK	øD	L	Weight (lbs.)
MT3-CKB1-47	CKB1	.748	1.850	.9
-CKB2-68	CKB2	.945	2.657	1.1
-CKB3-64	CKB3	1.220	2.520	1.3
-CKB5-48	CKB5	1.968	1.890	1.8
MT4-CKB1-52	CKB1	.748	2.028	1.5
-CKB2-74	CKB2	.945	2.913	1.8
-CKB3-66	CKB3	1.220	2.579	2.0
-CKB4-60	CKB4	1.535	2.343	2.2
-CKB5-50	CKB5	1.968	1.949	2.4
-CKB6-61	CKB6	2.520	2.382	3.5
MT5-CKB1-79	CKB1	.748	3.091	3.2
-CKB2-74	CKB2	.945	2.913	3.9
-CKB3-96	CKB3	1.220	3.760	4.2
-CKB4-86	CKB4	1.535	3.366	4.6
-CKB5-75	CKB5	1.968	2.933	7.3
-CKB6-61	CKB6	2.520	2.382	9.5
MT6-CKB6-61	CKB6	2.520	2.382	11.0

ACCESSORIES

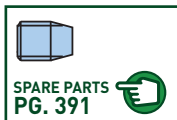

NMTB—CKB SHANKS

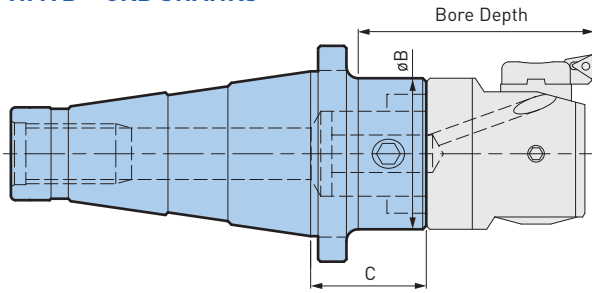

Catalog Number	Reference Number	CK	øD	L	X	Weight (lbs.)
N40-CKB6-45	11.321.562	CKB6	2.500	1.772	4.134	3.0
N50-CKB5-63	11.321.952	CKB5	1.968	2.480	3.940	7.0
-CKB6-49	11.321.962	CKB6	2.500	1.929	3.940	7.0
-CKB7-63	11.321.974	CKB7	3.543	2.480	5.865	8.5

ACCESSORIES



*For KAB7, Bore Depth dimension applies for boring heads with length of 4.606"

MANUAL TAPER—CKB SHANKS

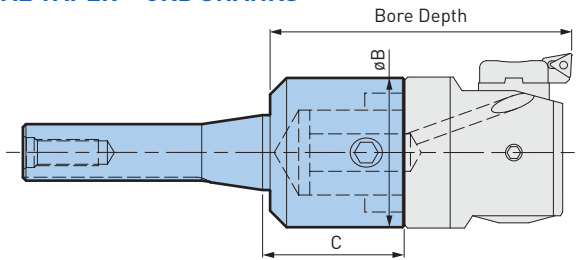

Catalog Number	Reference Number	CK	øD	L	X	Weight (lbs.)
R8-CKB6-60	11.362.261	CKB6	2.500	2.362	5.100	2.4
MK4-CKB6-130	10.322.563			3.189	5.118	4.0

ACCESSORIES



BORING MILL—CKB SHANKS

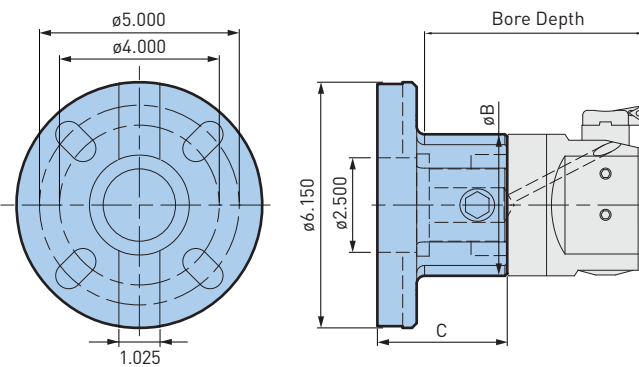

Type	Adapter Size	Bore Depth	Catalog Number	øB	C
6" Flange	CKB7	6.560*	11.366.774	3.543	3.250

ACCESSORIES



*For KAB7, Bore Depth dimension applies for boring heads with length of 4.606"

CKB ER COLLET ADAPTER—CKB

Precision Boring Heads Easily Used on Turning Machines

The new ER collet adapters, available in the sizes ER25 with CKB1 connection and ER32 with CKB1 and CKB2, enable the use of all BIG KAISER precision boring heads of the corresponding sizes on ER collet chucks in machining or turning centers. Thanks to full compatibility with the modular BIG KAISER extensions, long tool combinations can be achieved easily.

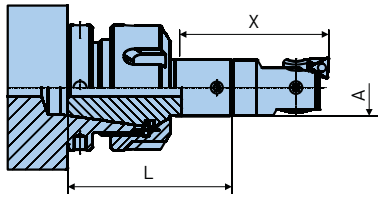

Fig. 1

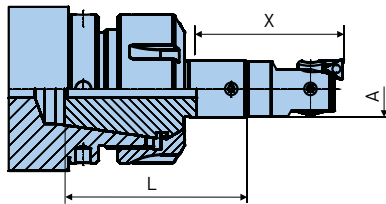

Fig. 2

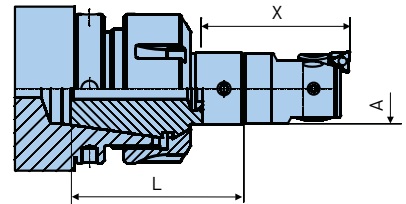

Fig. 3

Size	Catalog Number	Fig.	CKB/ø	L	X	A
ER25	10.335.130	1	CKB1/11	2.17	1.97	.75
ER32	10.335.131	2	CKB1/11	2.40	1.97	.75
	10.335.132	3	CKB2/14	2.28		.94

ER Collet Adapter CKB



ER Nut

CKB Extension

BIG KAISER Precision Boring Head CKB1/2

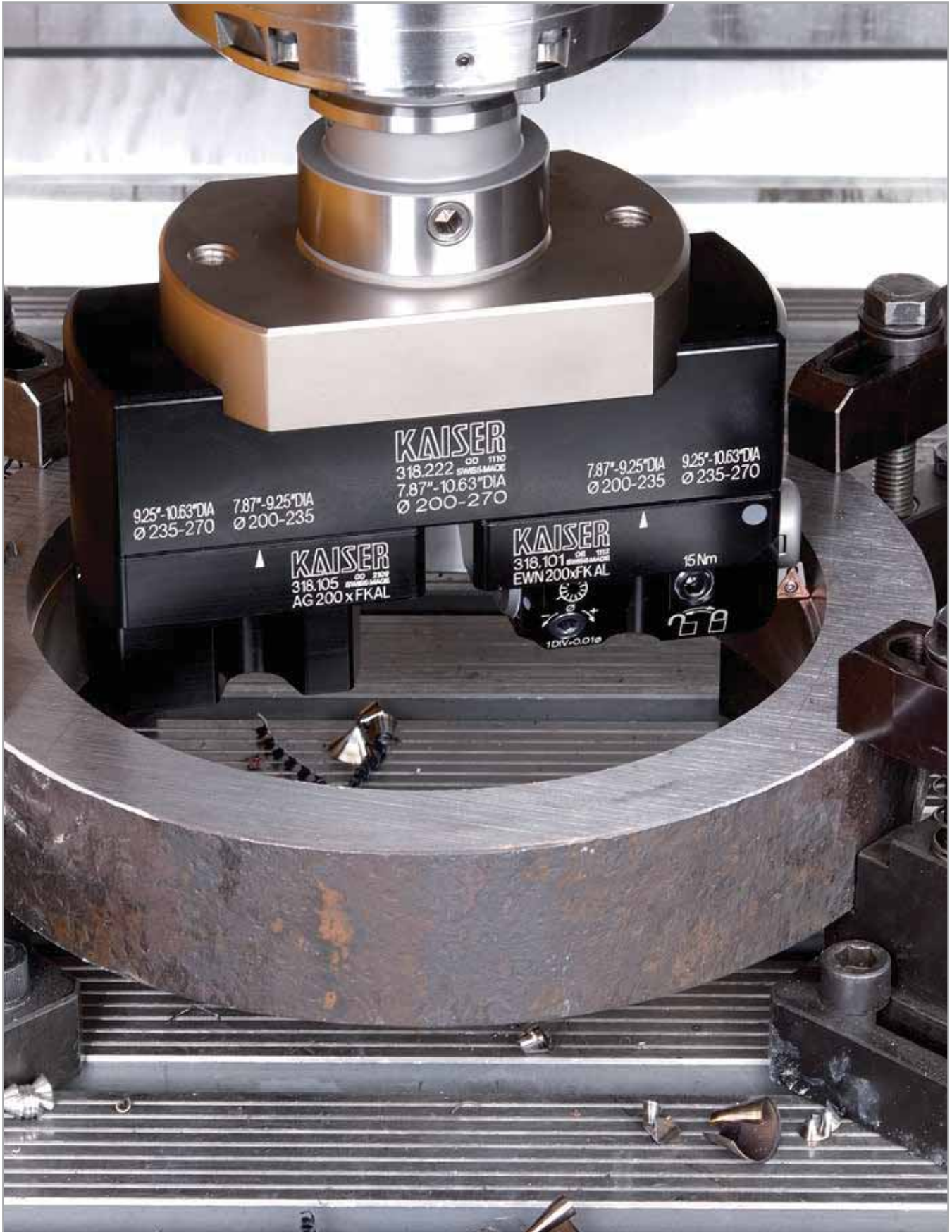

B.4 LARGE DIAMETER BORING

INDEXABLE INSERTS

B.5



INDEXABLE INSERTS**508-527**

APPLICATION ADVICE	508-509
WC-INSERTS FOR FINE BORING HEADS	510
TP/TC-INSERTS FOR FINE BORING HEADS	511-516
CC-INSERTS FOR FINE AND ROUGH BORING HEADS	517-521
SP/SC-INSERTS FOR ROUGH BORING HEADS	522-524
CLAMP SCREWS & WRENCHES	525-527
LUBRICATION GUN	527

APPLICATION ADVICE

This section contains a wide range of indexable inserts selected for fine boring or rough boring tools which have been tested under the most diverse working conditions.

For individual tool combinations comprehensive cutting data tables with detailed information about selection of insert, cutting speed, feed, stock allowance, ect. for different cutting methods are available on request.

CUTTING MATERIALS

ISO Main Groups	Work Piece Materials	ISO Application Groups				
P	Carbon Steels Cast Steel	P10	P20	P30	P40	P50
M	Stainless Steels	M10	M20	M30	M40	
K	Cast Iron	K10	K20	K30		
N	Aluminium Non-Ferrous Metals Synthetic Materials	N10				
S	Titanium NiCo Alloys High Temperature Alloys	S10	S20			

UNCOATED CARBIDE

Uncoated tungsten carbide with the addition of titanium carbide, tantalum carbide and cobalt as binding agents. Depending on the ISO group, these are suitable for rough boring and finishing of ferrous and non-ferrous materials.

COATED CARBIDE C

Multiple coatings improve resistance to wear, has a low friction coefficient and reduces built-up edge formation.

CERMET CT

Cermet cutting materials consist of titanium carbide and titanium nitride. They have high thermal and abrasion resistance and are suitable for finish boring and light rough-boring of steel & cast iron at high cutting speeds.

POLYCRYSTALLINE CUBIC BORON NITRIDE CBN

CBN cutting materials feature an extremely high wear and heat resistance. CBN inserts are suitable for boring hardened steel, up to 70 HRC, hard cast steel, cast iron and hard nickel alloys.

POLYCRYSTALLINE DIAMOND PCD

PCD cutting edges are extremely hard and abrasion-resistant. They permit high speed finish boring of non-ferrous materials and composites.

SYMBOLS

□	= Less Suitable
+	= Suitable
++	= First Choice

ISO CODE for Inserts for Boring and Turning

T	C	G	T	11	02	04	F	N
1	2	3	4	5	6	7	8	9

1	Insert Shape	2	Clearance Angle	3	Tolerance Class																
					<table border="1"> <tr> <td>Class</td> <td></td> <td></td> <td></td> </tr> <tr> <td>C</td> <td>±.001</td> <td>±.0005</td> <td>±.001</td> </tr> <tr> <td>G</td> <td>±.001</td> <td>±.001</td> <td>±.005</td> </tr> <tr> <td>M</td> <td>±.002-.0041)</td> <td>±.003-.0081)</td> <td>±.005</td> </tr> </table>	Class				C	±.001	±.0005	±.001	G	±.001	±.001	±.005	M	±.002-.0041)	±.003-.0081)	±.005
Class																					
C	±.001	±.0005	±.001																		
G	±.001	±.001	±.005																		
M	±.002-.0041)	±.003-.0081)	±.005																		
					1) Dependent upon insert size																

4	Chip Breaker/Mounting Criteria	5	Insert Size																																																																	
	<p>X = Special execution</p>		<table border="1"> <thead> <tr> <th>Size</th> <th>02</th> <th>03</th> <th>04</th> <th>05</th> <th>06</th> <th>07</th> <th>08</th> <th>09</th> <th>10</th> <th>11</th> <th>12</th> <th>16</th> </tr> </thead> <tbody> <tr> <td></td> <td>L IC</td> <td>.08 .156</td> <td>.12 .219</td> <td>.16 .250</td> <td>.20 .312</td> <td>.24 .375</td> <td>.31 .500</td> <td>.39 .625</td> <td>.50 .750</td> <td>.625 1.000</td> <td>1.000 1.500</td> <td>1.500 2.250</td> </tr> <tr> <td></td> <td>L IC</td> <td></td> <td></td> <td></td> <td></td> <td>7mm .165</td> <td></td> <td></td> <td></td> <td>11mm .250</td> <td></td> <td></td> </tr> <tr> <td></td> <td>L IC</td> <td></td> <td></td> <td></td> <td>.250 .250</td> <td></td> <td>.375 .375</td> <td></td> <td>.500 .500</td> <td>.625 .625</td> <td>.750 .750</td> <td>1.000 1.500</td> </tr> <tr> <td></td> <td>L IC</td> <td></td> <td></td> <td></td> <td>.250 .250</td> <td></td> <td>.375 .375</td> <td></td> <td>.500 .500</td> <td>.625 .625</td> <td>.750 .750</td> <td>1.000 1.500</td> </tr> </tbody> </table>	Size	02	03	04	05	06	07	08	09	10	11	12	16		L IC	.08 .156	.12 .219	.16 .250	.20 .312	.24 .375	.31 .500	.39 .625	.50 .750	.625 1.000	1.000 1.500	1.500 2.250		L IC					7mm .165				11mm .250				L IC				.250 .250		.375 .375		.500 .500	.625 .625	.750 .750	1.000 1.500		L IC				.250 .250		.375 .375		.500 .500	.625 .625	.750 .750	1.000 1.500
Size	02	03	04	05	06	07	08	09	10	11	12	16																																																								
	L IC	.08 .156	.12 .219	.16 .250	.20 .312	.24 .375	.31 .500	.39 .625	.50 .750	.625 1.000	1.000 1.500	1.500 2.250																																																								
	L IC					7mm .165				11mm .250																																																										
	L IC				.250 .250		.375 .375		.500 .500	.625 .625	.750 .750	1.000 1.500																																																								
	L IC				.250 .250		.375 .375		.500 .500	.625 .625	.750 .750	1.000 1.500																																																								

6	Insert Thickness	7	Corner Radius	8	Cutting Edge	9	Cutting Direction
	<p>01 s=.063 02 s=.094 (.098*) 03 s=.125 T3 s=.156 04 s=.187 05 s=.219</p> <p>*Special Size</p>		<p>01 R=.004 02 R=.008 03 R=.012 04 R=.016 06 R=.024 08 R=.031 12 R=.047</p>		<p>(W) For wiper geometry see page 515</p>		

INSERTS FOR FINE BORING HEADS

Insert								Work Piece Material							Machining					
Insert Shape	Reference Number	Catalog Number	Radius	Cutting Edge	Rake Angle γ	Grade	Coating	Construction Steels	Heat Treatable Steels	Stainless Steels	Cast Iron GG	Cast Iron GGG	AL/Non-Ferrous Metals	Hardened Steel ≤ 56 HRC	NiCo Alloys/Titanium	High Volume Machining	Unfavorable Conditions	Slightly Interrupted Cut	Heavily Interrupted Cut	HSC

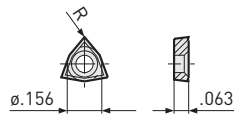

WCGT 0201

CIRCUMFERENCE GROUND, CHIP-BREAKERS PRESSED & POLISHED

	WCGT 0201	10.655.600	.008	FN	15°	P10CT	—	+	+			+				+						
		11.655.606	.016	FN	15°	P10CT	—	+	+			+					+					
		11.655.607	.008	FN	15°	P20	TN11	+	+	+	+											
		11.655.605	.008	FN	15°	P30	—	+	+										++	+		

CIRCUMFERENCE AND CHIP-BREAKERS GROUND

	WCGT 0201	10.655.604	.004	FL	23°	K10CT	—						++				++	+			
		10.655.601	.008	FL	23°	K10CT	—							++				++	+		
	WCGT 0201	10.655.605	.004	FL	23°	K10	TAN18	+	+	+	++	++	+	+	+		++				
		10.655.603	.008	FL	23°	K10	TAN18	+	+	+	++	++	+	+	+		++	+	+		
		10.655.606	.004	FL	23°	M10	ALCR10	++	++	++	+	+	+	+	+		+	++			
		10.655.602	.008	FL	23°	M10	ALCR10	++	++	++	+	+	+	++	++		++	+	+		



ONE CUTTING EDGE MADE WITH CBN OR PCD

	WCGW 0201	11.938.844	.004	FN	0°	PCD	—						++				++				+	
		11.938.845	.008	FN	0°	PCD	—							++				++				+
		11.938.846	.008	FN	0°	CBN	—								++							
		11.938.863	.008	FN	0°	CBN-CHN	—															

Torx Plus T6 IP M2x3.6 10.694.101

Torx Plus T6 IP 11.694.188

SYMBOLS

	= Less Suitable
+	= Suitable
++	= First Choice

INSERTS FOR FINE BORING HEADS

Insert								Work Piece Material								Machining				
Insert Shape	Reference Number	Catalog Number	Radius	Cutting Edge	Rake Angle γ	Grade	Coating	Construction Steels	Heat Treatable Steels	Stainless Steels	Cast Iron GG	Cast Iron GGG	AL/Non-Ferrous Metals	Hardened Steel ≤ 56 HRC	NiCo Alloys/Titanium	High Volume Machining	Unfavorable Conditions	Slightly Interrupted Cut	Heavily Interrupted Cut	HSC

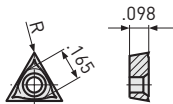

TPGT 0702

CIRCUMFERENCE GROUND, CHIP-BREAKERS PRESSED & POLISHED

	TPGT 0702	10.651.802	.008	FN	15°	P10CT	—	++	++			+				++				
		10.651.702	.016	FN	15°	P10CT	—	++	++			+					++			
	TPGT 0702	10.651.835	.008	FL	18°	P10CT	—	++	++			+	+				++			
		10.651.824	.004	FL	25°	K10	TAN18	+	+	+	+	+	+	+			++			
	TPGT 0702	10.651.735	.012	FL	25°	K10	TAN18	++	++	+	++	++	+	++	+	++		+		
		10.651.823	.004	FL	25°	K10	—							++			++			
		10.651.723	.012	FL	25°	K10	—									++		++	+	

TPMT 0702

CHIP-BREAKERS PRESSED

	TPMT 0702	10.651.713	.016	FN	15°	P10CT	ALCR10	++	++	+	+	+	+			++		+		
		10.651.813	.008	FN	15°	P10CT	ALCR10	++	++	+	+	+	+				++		+	

TPGT 0702

CIRCUMFERENCE AND CHIP-BREAKERS GROUND

	TPGT 0702	10.651.833	.008	FL	15°	P10	TAN18	+	+	+	+	+		+	+	+	++	+			
		10.651.838	.008	FL	18°	P10CT	TAN18	++	++	+	+	+	+		+	+	++				
		10.651.738	.012	FL	18°	P10CT	TAN18	++	++	+	+	+	+				++		+		
		10.651.839	.008	FL	15°	S10	TAN18			+						++	++	+	++	+	
	TPGT 0702	10.651.736	.012	FL	18°	P10CT	—	++	++			+	+			++					
	TPGT 0702	10.651.834	.008	FL	20°	P10	TAN18	+	+	+	+	+		++	+	+	++	+			
		10.651.734	.016	FL	20°	P10	TAN18	++	++	+	++	++		++	+	++			+		
		10.651.837	.008	FL	25°	M10	ALCR10	++	++	++	+	+	+	++	++	+	++				
		10.651.737	.012	FL	25°	M10	ALCR10	++	++	++	+	+	+	++	++	++			+		
	TPGT 0702	10.651.825	.008	FL	25°	K10	—							++		++	++			++	
		10.651.725	.016	FL	25°	K10	—								++		++				++

TPGW 0702

CIRCUMFERENCE GROUND WITHOUT CHIP-BREAKERS

	TPGW 0702	10.651.632	.012	FN	5°	K10	TAN18	+	+	+	++	+		++		++			+	
		10.651.623	.012	FN	5°	K10	—					+			+					+

Torx Plus T6 IP M2x4.8 10.694.103
 Torx Plus T6 IP M2x4.1 10.694.1021)

Torx Plus T6 IP 10.694.188

SYMBOLS

	= Less Suitable
+	= Suitable
++	= First Choice

γ Rake angle with insert on tool
 Clamping screw (10 screws and 1 wrench)
 1) For insert holders 10.615.205/10.615.207/10.615.507/
 10.615.508/10.615.271 Inserts are sold in packages of 10 pieces

INSERTS FOR FINE BORING HEADS

Insert								Work Piece Material							Machining					
Insert Shape	Reference Number	Catalog Number	Radius	Cutting Edge	Rake Angle γ	Grade	Coating	Construction Steels	Heat Treatable Steels	Stainless Steels	Cast Iron GG	Cast Iron GGG	AL/Non-Ferrous Metals	Hardened Steel ≤ 56 HRC	NiCo Alloys/Titanium	High Volume Machining	Unfavorable Conditions	Slightly Interrupted Cut	Heavily Interrupted Cut	HSC

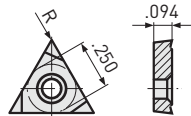

TCMT 1102

CHIP-BREAKERS PRESSED & POLISHED

	TCMT 1102	11.656.352	.008	FN	15°	P10CT	—	++	++			+				++		+			
		11.655.322	.016	FN	15°	P10CT	—	++	++			+					++		+		
		11.655.332	.031	FN	15°	P10CT	—	++	++			+					++		+		
	TCMT 1102	10.655.324	.016	FN	15°	P10CT	TAN18	++	++	+	+	+	+			++		+			
		10.655.334	.031	FN	15°	P10CT	TAN18	++	++	+	+	+	+			++		+			
		11.655.316	.016	FN	15°	S10	TN12	+	+	+								+	++	++	
	TCMT 1102	11.655.336	.031	FN	15°	S10	TN12	+	+	+								+	++	++	
		11.655.311	.008	FN	15°	P20	TN11	++	+		++	+					+	+	++		
		11.655.321	.016	FN	15°	P20	TN11	++	+		++	+					+		++	+	
	TCMT 1102	10.655.354	.016	FN	20°	M30C	AL10	++	++	++	+	+			++	++	++	++	++		
		10.655.364	.031	FN	20°	M30C	AL10	++	++	++	+	+			++	++	+	++	++		
	TCMT 1102	11.655.315	.008	FN	15°	K10	—				+							+	+		
		11.655.325	.016	FN	15°	K10	—				+								+	+	
		11.655.335	.031	FN	15°	K10	—				+								+	+	

TCGT 1102

CIRCUMFERENCE GROUND WITH CHIP-BREAKERS PRESSED

	TCGT 1102	10.655.301B	.008	FN	12°	K10	AL10	+	+	+	+	+		++		+	+	+			
		10.655.302B	.016	FN	12°	K10	AL10	++	++	++	+	+		++		+		+	+		
		10.655.303B	.031	FN	12°	K10	AL10	++	++	++	+	+		++		+		+	++		

TCGW 1102

CIRCUMFERENCE GROUND WITHOUT CHIP-BREAKERS

	TCGW 1102	10.655.301A	.008	FN	0°	K10	AL10				++	++				++	+	+			
		10.655.302A	.016	FN	0°	K10	AL10	+	+	+	++	++					++		+	+	
		10.655.303A	.031	FN	0°	K10	AL10	+	+	+	++	++					++		+	++	
	TCGW 1102	10.655.305	.016	FN	0°	K10	—				+									++	
		10.655.306	.031	FN	0°	K10	—				+										++

SYMBOLS

	= Less Suitable
+	= Suitable
++	= First Choice

INSERTS FOR FINE BORING HEADS

Insert								Work Piece Material							Machining					
Insert Shape	Reference Number	Catalog Number	Radius	Cutting Edge	Rake Angle γ	Grade	Coating	Construction Steels	Heat Treatable Steels	Stainless Steels	Cast Iron GG	Cast Iron GGG	AL/Non-Ferrous Metals	Hardened Steel ≤ 56 HRC	NiCo Alloys/Titanium	High Volume Machining	Unfavorable Conditions	Slightly Interrupted Cut	Heavily Interrupted Cut	HSC

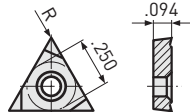

TCGT 1102

CIRCUMFERENCE GROUND, CHIP-BREAKERS PRESSED & POLISHED

	TCGT 1102	10.655.369	.004	FL	23°	M10	ALCR10	++	+	++	+	+	++	+	+	++					
		10.655.379	.008	FL	23°	M10	ALCR10	++	+	++	+	+	++	+	+	++					
		10.655.389	.016	FL	23°	M10	ALCR10	++	+	++	+	+	++	+	++	+	+				
		10.655.399	.031	FL	23°	M10	ALCR10	++	+	++	+	+	++	+	++	+	++		++	+	
	TCGT 1102	10.655.363	.004	FL	23°	K10	TAN18	+	+	+	+	+					++				
		10.655.373	.008	FL	23°	K10	TAN18	+	+	+	+	+					+				
		10.655.383	.016	FL	23°	K10	TAN18	++	++	+	++	++	+	++	+	++			+		
		10.655.393	.031	FL	23°	K10	TAN18	++	++	+	++	++	+	++	+	++			+		
	TCGT 1102	10.655.378	.008	FL	23°	K10	—						++			+	++				
		10.655.388	.016	FL	23°	K10	—						++			++	+	+			
		10.655.398	.031	FL	23°	K10	—						++			++		+			
	TCGT 1102	10.655.371	.008	FL	15°	P10	TAN18	+	+		+	+		+			++				
		10.655.381	.016	FL	18°	P10	TAN18	+	+	+	+	+	+	+	+				+		

TCGT 1102

CIRCUMFERENCE AND CHIP-BREAKERS GROUND

	TCGT 1102	10.655.370	.008	FL	10°	K20	TAN18	++	++	+	++	++	+	++		+	++	++	+	
		10.655.380	.016	FL	10°	K20	TAN18	++	++	+	++	++	+	++		++		++	++	
		10.655.390	.031	FL	10°	K20	TAN18	++	++	+	++	++	+	++		++		++	++	
	TCGT 1102	10.655.372	.008	FN	20°	P10CT	—	+	+								++			
		10.655.386	.016	FL	18°	P10CT	—	++	++			+	+			++				
	TCGT 1102	10.655.375	.008	FL	15°	P10CT	TAN18	++	++	+	+	+	+			+	++			
		10.655.385	.016	FL	18°	P10CT	TAN18	++	++	+	+	+	+			++	+			
		10.655.395	.031	FL	18°	P10CT	TAN18	++	++	+	+	+	+			++				
	TCGT 1102	10.655.387	.016	FL	20°	K10	—						++			++	+		++	
		10.655.397	.031	FL	20°	K10	—							++			++			++
	TCGT 1102	10.655.319	.008	FL	23°	M20	ALCR20	++	++	++	++	++	+	++	++	++	+	++	+	
		10.655.327	.012	FL	23°	M20	ALCR20	++	++	++	++	++	+	++	++	++	++	+	++	+
		10.655.318	.016	FL	23°	M20	ALCR20	++	++	++	++	++	+	++	++	++	++	+	++	+
		10.655.328	.024	FL	23°	M20	ALCR20	++	++	++	++	++	+	++	++	++	++	+	++	+
		10.655.320	.031	FL	23°	M20	ALCR20	++	++	++	++	++	+	++	++	++	++	+	++	+

Torx Plus T7 IP M2.5x6.5 10.694.122

Torx Plus T7 IP 10.694.189

SYMBOLS

	= Less Suitable
+	= Suitable
++	= First Choice

γ Rake angle with insert on tool

Clamping screw (10 screws and 1 wrench)

Inserts are sold in packages of 10 pieces

INSERTS FOR FINE BORING HEADS

Insert							Work Piece Material							Machining						
Insert Shape	Reference Number	Catalog Number	Radius	Cutting Edge	Rake Angle γ	Grade	Coating	Construction Steels	Heat Treatable Steels	Stainless Steels	Cast Iron GG	Cast Iron GGG	AL/Non-Ferrous Metals	Hardened Steel \leq 56 HRC	NiCo Alloys/Titanium	High Volume Machining	Unfavorable Conditions	Slightly Interrupted Cut	Heavily Interrupted Cut	HSC

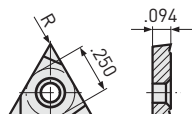

WIPER TCGX 1102

CIRCUMFERENCE AND CHIP-BREAKERS GROUND

	TCGX 1102	10.655.317N	.016	WL	20°	K10	—								++	++	++		+	+	++
	TCGX 1102	10.655.315N	.016	WL	20°	P10CT	TAN18	++	++			+	+	+		++			+	+	++
	TCGX 1102	10.655.310N	.016	WL	20°	K10	ALCR10	++	++	++	++	+	+	+	+	++			+	+	++

WIPER TCGX 1102

CIRCUMFERENCE GROUND, CHIP-BREAKERS PRESSED

	TCGX 1102	10.655.374	.016	WL	15°	K10	—	++	++	+	+	+				++					++	
	TCGX 1102	11.655.327	.016	WL	15°	P10CT	—	++	++			+	+			++						

WIPER GEOMETRY

Comparison with standard nose radius .016

Wiper:

Two times the feed rate → Same surface finish

Same feed rate → Two times better surface finish

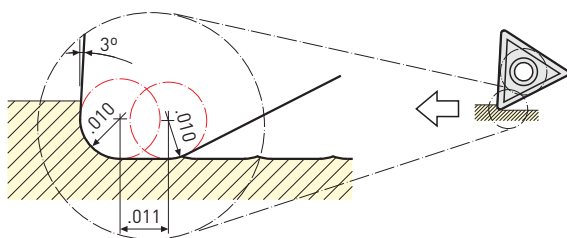

Torx Plus T7 IP M2.5x6.5 10.694.122

Torx Plus T7 IP 10.694.189

SYMBOLS

	= Less Suitable
+	= Suitable
++	= First Choice

CBN/PCD INSERTS FOR FINE BORING HEADS

Insert							Work Piece Material						Machining				
Insert Shape	Reference Number	Catalog Number	Radius	Cutting Edge	Rake Angle γ	Grade	Cast Iron GG	Cast Iron GGG	AL/Non-Ferrous Metals	Hardened Steel ≤ 56 HRC	NiCo Alloys/Titanium	Carbon Fibers	High Volume Machining	Unfavorable Conditions	Slightly Interrupted Cut	Heavily Interrupted Cut	HSC

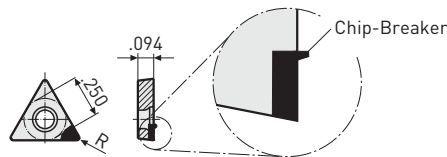

TCMW 11

ONE CUTTING EDGE MADE WITH PCD

	TCMW 1102	11.938.832	.016	FL	25°	PCD			+			++	++		+		++
--	-----------	-------------------	------	----	-----	-----	--	--	---	--	--	----	----	--	---	--	----

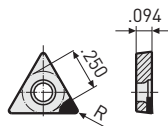

TCMW 11

ONE CUTTING EDGE MADE WITH PCD/CBN

	TCMW 1102	11.938.861	.008	FN	0°	PCD			++			+	++		+		+
		10.938.841	.016	FN	0°	PCD			++			+	++		+		+
		11.938.860	.031	FN	0°	PCD			++			+	++		+		+
	TCGX1102	11.938.873	.031	FN	0°	PCD			++								
	TCMW 1102	10.948.310	.008	FN	0°	CBN-CHN	++	++			+		++	++			
		11.938.833	.016	FN	0°	CBN-CH	++	++			+		++	+	+		
		11.938.849	.031	FN	0°	CBN-CH	++	++			+		++		+		
		10.938.834	.016	FN	0°	CBN				++	+		++	+	+		
		10.948.330	.008	TN	0°	CBN-CH	++	++					++		+		
		10.948.331	.016	TN	0°	CBN-CH	++	++					++		+		
		11.938.864	.016	FN	0°	CBN-CHN				++	+		+				
11.938.865	.031	TN	0°	CBN				++		+	++		++	+			

TCMW 11

THREE CUTTING EDGES MADE WITH CBN

	TCMW 1102	10.948.350A	.008	FN	0°	CBN			++	++		+	+			
		10.948.351A	.016	FN	0°	CBN			++	++		+				
		10.948.352A	.031	FN	0°	CBN			++	++		++		+		

Torx Plus T7 IP M2.5x6.5 10.694.122

Torx Plus T7 IP 10.694.122

* .031"R with wiper

γ Rake angle with insert on tool

Clamping screw (10 screws and 1 wrench)

1) For insert holders 10.615.205/10.615.207/10.615.507/

10.615.508/10.615.271 CBN/PCD inserts are sold individually

SYMBOLS

	= Less Suitable
+	= Suitable
++	= First Choice

INSERTS FOR FINE & ROUGH BORING HEADS

Insert								Work Piece Material							Machining					
Insert Shape	Reference Number	Catalog Number	Radius	Cutting Edge	Rake Angle γ	Grade	Coating	Construction Steels	Heat Treatable Steels	Stainless Steels	Cast Iron GG	Cast Iron GGG	AL/Non-Ferrous Metals	Hardened Steel ≤ 56 HRC	NiCo Alloys/Titanium	High Volume Machining	Unfavorable Conditions	Slightly Interrupted Cut	Heavily Interrupted Cut	HSC

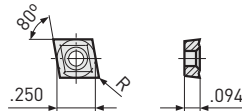

CCMT 0602

CHIP-BREAKERS PRESSED & POLISHED

	CCMT 0602	11.654.840	.008	FN	15°	P20	TN11	+	+	+	+	+			+		+			
	CCMT 0602	11.654.858	.016	FN	15°	K20	—				+	+								+
	CCMT 0602	11.654.850	.016	FN	15°	P20	TN11	++	++	+	+	+		+	+	++		+		
		11.654.860	.031	FN	15°	P20	TN11	++	++	+	++	++		+	+	++	+	+	+	
	CCMT 0602	11.654.853	.016	FN	15°	P35	TN12	++	++	++	+	+		+	+	++		++	++	
	CCMT 0602	11.654.869	.031	FN	15°	P35	TN12	++	++	+	+	+		+	+	++		++	++	
	CCMT 0602	11.654.856	.008	FN	15°	P20	CT52	++	++	+	+	+		+	+	++				
		11.654.865	.016	FN	15°	P20	CT52	++	++	+	+	+		+	+	++				
		11.654.867	.031	FN	15°	P20	CT52	++	++	+	+	+		+	+	++				

CCGT 0602

CIRCUMFERENCE GROUND, CHIP-BREAKERS PRESSED & POLISHED

	CCGT 0602	10.654.837	.008	FN	8°	S10	TN18			++				++	++	++	+			
		10.654.847	.016	FN	8°	S10	TN18			++				++	++	+	+			

CCMT 0602

CHIP-BREAKERS GROUND

	CCMT 0602	10.654.877	.008	FL	23°	K10	—						++		++	+	+				
		10.654.888	.016	FL	23°	K10	—							++	+	++	+	+			
		11.654.898	.031	FL	23°	K10	—							++	+	++	+	+			
	CCMT 0602	10.654.879	.008	FL	23°	N10	ALCR10						++	+	++	+	+				
		10.654.889	.016	FL	23°	N10	ALCR10							++	+	++	+	+			

Torx Plus T7 IP M2.5x6.5 10.694.122

Torx Plus T7 IP 10.694.189

- γ Rake angle with insert on tool
- Clamping screw (10 screws and 1 wrench)
Inserts are sold in packages of 10 pieces

SYMBOLS

	= Less Suitable
+	= Suitable
++	= First Choice

• See Pg. 521 for PCD/CBN inserts

INSERTS FOR FINE & ROUGH BORING HEADS

Insert							Work Piece Material							Machining						
Insert Shape	Reference Number	Catalog Number	Radius		Rake Angle γ	Grade	Coating	Construction Steels	Heat Treatable Steels	Stainless Steels	Cast Iron GG	Cast Iron GGG	AL/Non-Ferrous Metals	Hardened Steel ≤ 56 HRC	NiCo Alloys/Titanium	High Volume Machining	Unfavorable Conditions	Slightly Interrupted Cut	Heavily Interrupted Cut	HSC

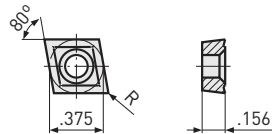

CCMT 09T3

CHIP-BREAKERS PRESSED & POLISHED

	CCMT 09T3	11.654.957	.016	FN	15°	K20	—				++	++			+	++		+			
		11.654.958	.031	FN	15°	K20	—				++	++			+	++		+			
		11.654.940	.016	FN	15°	P20	TN11	++	++	+	+			+	+	++		++	+		
	CCMT 09T3	11.654.952	.031	FN	15°	P20	TN11	++	++	++	+	+		+	+	++		++	+		
		11.654.943	.016	FN	15°	P35	TN12	++	++	++	+	+		+	+	++		++	++		
		11.654.953	.031	FN	15°	P35	TN12	++	++	++	+	+		+	+	++		++	++		
	CCMT 09T3	11.654.959	.016	FN	15°	P10CT		+	+	+						++					
		11.654.960	.031	FN	15°	P10CT		+	+	+						++					

CCGT 09T3

CIRCUMFERENCE GROUND, CHIP-BREAKERS PRESSED & POLISHED

	CCGT 09T3	10.654.947	.016	FN	15°	P10CT	—	++	++	++						++	+	+		
		10.654.957	.031	FN	15°	P10CT	—	++	++	++							++		+	

CCMT 09T3

CHIP-BREAKERS GROUND

	CCMT 09T3	10.654.977	.016	FL	23°	K10	—						++			++	+	+		
		10.654.987	.031	FL	23°	K10	—							++			++		+	
	CCMT 09T3	10.654.949	.016	FL	23°	N10	ALCR10						++	+		++	+	+		
		10.654.959	.031	FL	23°	N10	ALCR10							++	+		++		+	

Torx Plus T15 IP M4x9.2 10.694.141

Torx Plus T15 IP 10.694.193

SYMBOLS

	= Less Suitable
+	= Suitable
++	= First Choice

• See Pg. 521 for PCD/CBN inserts

INSERTS FOR FINE & ROUGH BORING HEADS

Insert							Work Piece Material							Machining						
Insert Shape	Reference Number	Catalog Number	Radius		Rake Angle γ	Grade	Coating	Construction Steels	Heat Treatable Steels	Stainless Steels	Cast Iron GG	Cast Iron GGG	AL/Non-Ferrous Metals	Hardened Steel ≤ 56 HRC	NiCo Alloys/Titanium	High Volume Machining	Unfavorable Conditions	Slightly Interrupted Cut	Heavily Interrupted Cut	HSC

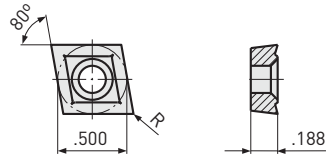

CCMT 1204

CHIP-BREAKERS PRESSED & POLISHED

	CCMT 1204	11.654.989	.016	FN	15°	K20	—				++	++			+	++		+		
		11.654.991	.031	FN	15°	K20	—					++	++			+	++		+	
	CCMT 1204	11.654.993	.016	FN	15°	P20	TN11	++	++	++	+	+		+	+	++	++	++	++	
		11.654.990	.031	FN	15°	P20	TN11	++	++	++	+	+		+	+	++	++	++	++	
	CCMT 1204	11.654.984	.031	FN	15°	P10CT	—	+	+	+						+				
	CCMT 1204	11.654.983	.031	FN	15°	P35	TN12			++				+	+	++		++	+	

CCMT 1204

CHIP-BREAKERS GROUND

	CCMT 1204	10.654.995	.016	FL	23°	K10							++			++	+	+		
		10.654.992	.031	FL	23°	K10								++			++		+	
	CCMT 1204	10.654.978	.016	FL	23°	N10							++		++	++	+	+	+	
		10.654.979	.031	FL	23°	N10								++		++	++		+	+

Torx Plus T20 IP M5x13.3 10.694.150

Torx Plus T20 IP 10.694.194

SYMBOLS

	= Less Suitable
+	= Suitable
++	= First Choice

• See Pg. 521 for PCD/CBN inserts

INSERTS FOR ROUGH BORING HEADS

Insert							Work Piece Material							Machining						
Insert Shape	Reference Number	Catalog Number	Radius		Rake Angle γ	Grade	Coating	Construction Steels	Heat Treatable Steels	Stainless Steels	Cast Iron GG	Cast Iron GGG	AL/Non-Ferrous Metals	Hardened Steel \leq 56 HRC	NiCo Alloys/Titanium	High Volume Machining	Unfavorable Conditions	Slightly Interrupted Cut	Heavily Interrupted Cut	HSC

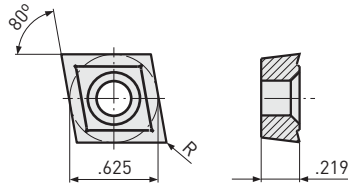

CCMT 1605

CHIP-BREAKERS PRESSED & POLISHED

	CCMT 1605	10.654.997	.031	FN	15°	K10	—				+	+			+			+		
	CCMT 1605	11.654.996	.031	FN	15°	P20	TN11	++	++	+	+	+		+	+	++				
		10.654.996	.031	FN	15°	P30	TN14	++	++	+	+	+		+	+	++		++	+	
	CCMT 1605	11.656.370	.031	FN	15°	P30	TN16	++	++	+	+	+		+	+	++		++	++	

CCMT 1605

CHIP-BREAKERS GROUND

	CCMT 1605	10.654.998	.031	FL	23°	K10								++		+	++			+	
--	-----------	-------------------	------	----	-----	-----	--	--	--	--	--	--	--	----	--	---	----	--	--	---	--

Torx Plus T20 IP M5x13.3 10.694.150

Torx Plus T20 IP 10.694.194

SYMBOLS

	= Less Suitable
+	= Suitable
++	= First Choice

CBN/PCD INSERTS FOR FINE & ROUGH BORING HEADS

Insert							Work Piece Material						Machining				
Insert Shape	Reference Number	Catalog Number	Radius		Rake Angle γ	Grade	Cast Iron GG	Cast Iron GGG	AL/Non-Ferrous Metals	Hardened Steel ≤ 56 HRC	NiCo Alloys/Titanium	Carbon Fibers	High Volume Machining	Unfavorable Conditions	Slightly Interrupted Cut	Heavily Interrupted Cut	HSC

CCMW 06

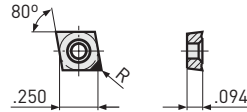

ONE CUTTING EDGE MADE WITH PCD/CBN

	CCMW 0602	11.938.847	.008	FL	5°	PCD			++			++	++		+		
		11.938.842	.016	FL	5°	PCD											
	CCMW 0602	11.938.835	.016	FN	0°	CBN-CH	++	+					++				

Torx Plus T7 IP M2.5x6.5 10.694.122

Torx Plus T7 IP 10.694.189

CCMW 09

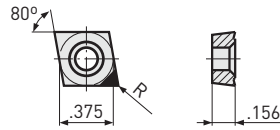

ONE CUTTING EDGE MADE WITH PCD/CBN

	CCMW 09T3	11.938.843	.016	FL	5°	PCD			++			++	++		+		
		11.938.851	.031	FL	5°	PCD			++				++	++		+	
	CCMW 09T3	11.938.838	.016	FN	0°	CBN-CH	++	+					++		+		

Torx Plus T15 IP M4x9.2 10.694.141

Torx Plus T15 IP 10.694.193

CCMW 12

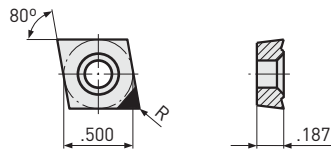

ONE CUTTING EDGE MADE WITH PCD/CBN

	CCMW 1204	10.938.870	.016	FL	5°	PCD			++			++	++	+	+		
		10.938.871	.031	FL	5°	PCD			++				++	++		+	
	CCMW 1204	10.938.862	.031	FN	0°	CBN-CH	++	+					++		+		

Torx Plus T20 IP M5x13.3 10.694.150

Torx Plus T20 IP 10.694.194

CBN/PCD inserts are sold individually

SYMBOLS

	= Less Suitable
+	= Suitable
++	= First Choice

INSERTS FOR ROUGH BORING HEADS

Insert							Work Piece Material							Machining						
Insert Shape	Reference Number	Catalog Number	Radius		Rake Angle γ	Grade	Coating	Construction Steels	Heat Treatable Steels	Stainless Steels	Cast Iron GG	Cast Iron GGG	AL/Non-Ferrous Metals	Hardened Steel ≤ 56 HRC	NiCo Alloys/Titanium	High Volume Machining	Unfavorable Conditions	Slightly Interrupted Cut	Heavily Interrupted Cut	HSC

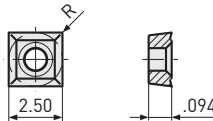

SPMT 0602

CHIP-BREAKERS PRESSED & POLISHED

	SPMT 0602	10.654.150	.016	FN	15°	P20	TN11	++	++	++	+	+		+	+	+			+	
	SPMT 0602	10.654.158	.016	FN	15°	K20	—				+								++	
	SPMT 0602	10.654.152	.016	FN	15°	K20	TN16				++	++		+	+	+			+	

SPMT 0602

CHIP-BREAKERS GROUND

	SPMT 0602	10.654.168	.016	FL	23°	K10	—						++		+	+			+	
--	-----------	-------------------	------	----	-----	-----	---	--	--	--	--	--	----	--	---	---	--	--	---	--

Torx Plus T7 IP M2.5x6.5 10.694.122

Torx Plus T7 IP 10.694.189

SYMBOLS

	= Less Suitable
+	= Suitable
++	= First Choice

INSERTS FOR ROUGH BORING HEADS

Insert							Work Piece Material							Machining						
Insert Shape	Reference Number	Catalog Number	Radius		Rake Angle γ	Grade	Coating	Construction Steels	Heat Treatable Steels	Stainless Steels	Cast Iron GG	Cast Iron GGG	AL/Non-Ferrous Metals	Hardened Steel ≤ 56 HRC	NiCo Alloys/Titanium	High Volume Machining	Unfavorable Conditions	Slightly Interrupted Cut	Heavily Interrupted Cut	HSC

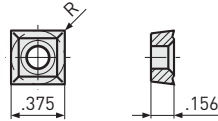

SCMT 09T3

CHIP-BREAKERS PRESSED

	SCMT 09T3	11.654.249	.016	FN	15°	K30	—				+	+								+		
		11.654.259	.031	FN	15°	K30	—					+	+								+	
	SCMT 09T3	11.654.240	.016	FN	15°	P20	TN11	++	++	++	++	++		+		+	+	+				
		11.654.250	.031	FN	15°	P20	TN11	++	++	++	++	++		+		+	+	+				
	SCMT 09T3	11.654.247	.016	FN	15°	P30	TN12	++	++	+	+	+		+		++		++	++			
		11.654.200	.031	FN	15°	P30	TN12	++	++	+	+	+		+		++		++	++			

SCMT 09T3

CHIP-BREAKERS GROUND

	SCMT 09T3	10.654.277	.016	FL	23°	K10							++			+	+	+			
		10.654.287	.031	FL	23°	K10								++			+				+

Torx Plus T15 IP M4x9.2 10.694.141

Torx Plus T15 IP 10.694.193

SYMBOLS

	= Less Suitable
+	= Suitable
++	= First Choice

INSERTS FOR ROUGH BORING HEADS

Insert							Work Piece Material							Machining						
Insert Shape	Reference Number	Catalog Number	Radius		Rake Angle γ	Grade	Coating	Construction Steels	Heat Treatable Steels	Stainless Steels	Cast Iron GG	Cast Iron GGG	AL/Non-Ferrous Metals	Hardened Steel ≤ 56 HRC	NiCo Alloys/Titanium	High Volume Machining	Unfavorable Conditions	Slightly Interrupted Cut	Heavily Interrupted Cut	HSC

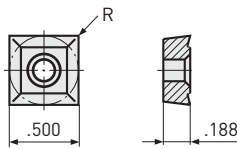

SCMT 1204

CHIP-BREAKERS PRESSED & POLISHED

	SCMT 1204	11.654.340	.016	FN	15°	P20	TN11	+	+	+	+	+		+			+	+			
		11.654.350	.031	FN	15°	P20	TN11	++	++	++	++	+		+		+				+	
		11.654.360	.047	FN	15°	P20	TN11	++	++	++	++	+		+		+					+
	SCMT 1204	11.654.353	.031	FN	15°	P30	TN12	+	+	+		+							++	++	
	SCMT 1204	11.654.359	.031	FN	15°	K20	—					+	+	+	+				++	++	

SCMT 1204

CHIP-BREAKERS GROUND

	SCMT 1204	10.654.387	.031	FL	23°	K10	—							++							+	
--	-----------	-------------------	------	----	-----	-----	---	--	--	--	--	--	--	----	--	--	--	--	--	--	---	--

- Torx Plus T20 IP M4 x 11.6 10.694.142
For insert holder RW53
- Torx Plus T20 IP M4x15 10.694.144
For insert holder RW 68/RW100
- Torx Plus T20 IP M5 x 13.3 10.694.150
For insert holder «TW» and «SW»

- Torx Plus T20 IP 10.694.194

- γ Rake angle with insert on tool
- Clamping screw (10 screws and 1 wrench)
- Inserts are sold in packages of 10 pieces

SYMBOLS

	= Less Suitable
+	= Suitable
++	= First Choice

CLAMP SCREWS & WRENCHES FOR INSERTS

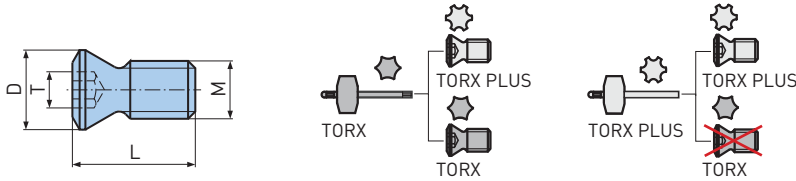



Dimensions				Nm*	Screws		Wrench	
Torx/ Torx Plus	Thread M	øD	L		Torx	Torx Plus	Torx	Torx Plus
					Catalog Number	Catalog Number	Catalog Number	Catalog Number
T6	M2	.118	.157	.5	10.335.035	—	10.690.834	—
T6 IP	M2	.106	.142		—	10.694.101	—	10694.806
T6 IP	M2	.106	.161			10.694.102		
T6 IP	M2	.106	.189			10.694.103		
T7 IP	M2.2	.138	.236	.7	—	10.694.110	—	10.694.807
T7 IP	M2.5	.138	.256			10.694.122		
T7 IP	M2.5	.138	.228			10.694.123		
T7 IP	M2.5	.138	.248			10.694.124		
T7 IP	M2.5	.169	.217			10.694.121		
T7 IP	M3	.181	.236			10.694.130		
T8	M3	.173	.354	.8	10.958.048	—	10.690.836	—
T8 IP	M2.5	.138	.343		—	10.694.125	—	10.694.808
T9 IP	M3	.173	.323	1.5	—	10.694.131	—	10.694.809
T10	M3	.161	.276	1.8	10.335.036	—	10.690.837	—
T10 IP	M3.5	.189	.362		—	10.694.137	—	10.694.810
T10 IP	M3.5	.217	.323			10.694.136		
T15	M4	.224	.323	3.0	10.336.905	—	10.690.843	—
T15 IP	M4	.201	.362		—	10.694.141	—	10.694.815
T15 IP	M4	.217	.465			10.694.143		
T20	M5	.260	.650	6.0	10.958.049	—	10.690.838	—
T20	M5	.276	.472		10.335.037			
T20 IP	M4	.252	.590		—	10.694.144	—	10.694.820
T20 IP	M4	.256	.457			10.694.142		
T20 IP	M5	.276	.524			10.694.150		

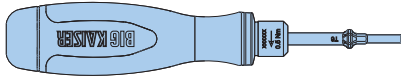

***Maximum tightening torque**

- The clamping screws for the inserts are supplied in packages of 10 pieces with a corresponding wrench

WRENCHES FOR INSERTS



Size	Torque	Set		Catalog Number
		Torque Wrench	Torx Blade	
Torx 6	.5 Nm			10.694.181
Torx 7	.7 Nm	10.694.160	10.694.167 T6	10.694.182
Torx 8	.8 Nm	10.694.161	10.694.168 T7	10.694.183
Torx 9	1.5 Nm	10.694.162	10.694.169 T8	10.694.184
Torx 10	1.8 Nm	10.694.163	10.694.170 T9	10.694.185
Torx 15	3.0 Nm	10.694.164	10.694.171 T10	10.694.186
Torx 20	5.0 Nm	10.694.165	10.694.172 T15	10.694.187

Size	Torque	Set		Catalog Number
		Torque Wrench	Torx Plus Blade	
Torx 6	.5 Nm			10.694.188
Torx 7	.7 Nm	10.694.160	10.694.174 IP6	10.694.189
Torx 8	.8 Nm	10.694.161	10.694.175 IP7	10.694.190
Torx 9	1.5 Nm	10.694.162	10.694.176 IP8	10.694.191
Torx 10	1.8 Nm	10.694.163	10.694.177 IP9	10.694.192
Torx 15	3.0 Nm	10.694.164	10.694.178 IP101	10.694.193
Torx 20	5.0 Nm	10.694.165	10.694.179 IP15	10.694.194

WRENCHES FOR INSERTS

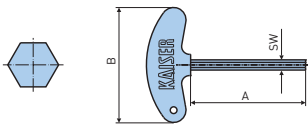

A	B	SW	Catalog Number
2.0	1.77	1.5mm	10.690.819
		2mm	10.690.811
		2.5mm	10.690.812
		3mm	10.690.813
		4mm	10.690.814
2.8	2.56	5mm	10.690.816
		6mm	10.690.817

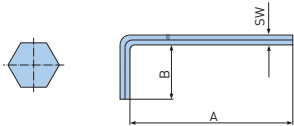

A	B	SW	Catalog Number
1.7	.55	1.3mm	10.690.833
2.0		1.5mm	10.690.800
2.0	.63	2mm	10.690.801
2.2	.71	2.5mm	10.690.802
2.5	.79	3mm	10.690.803
2.6	.94	3.5mm	10.690.899
2.8	.98	4mm	10.690.804
3.1	1.10	5mm	10.690.805
3.5	1.26	6mm	10.690.806
3.9	1.42	8mm	10.690.807
4.4	1.57	10mm	10.690.810
7.9		10mm	10.690.808
4.9	1.77	12mm	10.690.809
5.5	2.20	14mm	10.690.832
5.5	2.48	17mm	10.690.861

LUBRICATION GUN

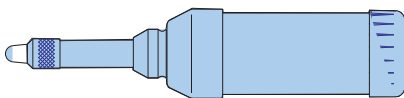

Catalog Number
10.692.404A

CAUTION

Lubricant
For lubricating the fine boring heads type AW, EW, EWN, EWD, EWB, EWB-UP a light machine oil of the following types are recommended:

- Mobil Vactra Oil No. 2
- BP Energol HLP-32
- Klueber Isoflex PDP 94

The lubricating instructions are shown in the operating instructions that are included with each head.

CUTTING TOOLS

C.1



DRILLS	530-541
INDEXABLE INSERT DRILLS OVERVIEW	530-531
INDEXABLE INSERT DRILLS	532-539
SPADE DRILLS	540-541
INDEXABLE END MILLS	542-559
FULLCUT MILL	542-559
EXCHANGEABLE HEAD MILLING TOOLS	560-565
CONTACT GRIP	560-565
INDEXABLE FACE MILLS	566-571
FULLCUT MILL ARBOR TYPE	566-567
SPEED FINISHER	568-569
SURFACE MILL	570-571
CHAMFER MILLS	572-585
C-CUTTER MINI	572-577
C-CUTTER	578-581
C-CUTTER MICRO	582
C-CENTERING CUTTER	583
CENTER BOY	584
C-CUTTER BOY	585
RADIUS MILLS	586-589
R-CUTTER	586-589
BACK COUNTERBORING TOOLS	590-591
BF-CUTTER	590-591
GROOVE MILLING TOOLS	592-593
GROOVE MILLING TOOLS	592-593



SERIES 336 INSERT DRILL

- Large, helical flutes reinforced at the edges provide highest strength and chip space
- Through the tool coolant, directed on both sides at the cutting edges to guarantee optimum cooling and chip evacuation
- Case hardened steel construction for maximum rigidity and toughness

CKB6 AND CKB7 CONNECTION PROVIDES:

- Highest stability by clamping the drill to the shank both axially and radially at the largest seating diameter
- Lowest amount of drill runout
- Minimum gauge lengths
- Versatile CKB6 connection for all diameters 3/4" to 2-1/2" allows more flexibility on smaller machines
- Widest range of shanks and coolant inducers

CARBIDE INSERTS:

- ISO standard WCMX inserts for both inside and outside cutting edges provide 3 indexes
- Positive cutting geometry for reduced cutting forces
- Different grades optimize cutting conditions

INSERT DRILL SIZES:

- CKB6 connection, $\varnothing 3/4"$ to $\varnothing 2-1/2"$ and $\varnothing 31\text{mm}$ to $\varnothing 61\text{mm}$
- CKB7 connection, $\varnothing 2-5/8"$ to $\varnothing 2-7/8"$

INSERT DRILL LENGTHS:

- 2xD and 3xD for all sizes





SERIES 337 INSERT DRILL

- Straight flute design guarantees a short distance for chip evacuation, high radial and torsional rigidity, and very high cutting performance
- Clockwise cutting, with 4-edge inserts, also suitable to enlarge pre-drilled holes
- Through tool coolant supply to the cutting edge
- Suitable for use as rotating or stationary
- With adjustable drill holder for hole diameters with fractional sizes such as core bores or rough bores before finishing (adjustment range according to table)

CKB6 CONNECTION PROVIDES:

- Very high clamping force, a short gauge length and a large seating diameter
- Suitable for drilling under extreme conditions such as inclined surfaces, semi-circle bores and transverse bores

CARBIDE INSERTS:

- Same insert type for inner and outer insert
- Indexable inserts for all kinds of workpiece materials, with 4 true cutting edges

INSERT DRILL SIZES:

- CKB6 connection, $\varnothing 16\text{mm}$ to $\varnothing 30\text{mm}$

INSERT DRILL LENGTHS:

- 3xD and 4xD for all sizes



INDEXABLE INSERT DRILL—SERIES 336

INCH

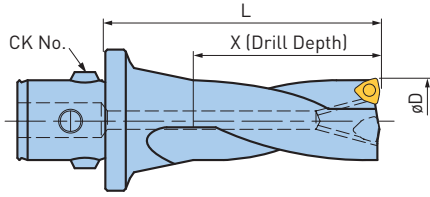

Drill øD	CK	Indexable Drills 2x Dia.			Indexable Drills 3x Dia.			Inside Insert	Outside Insert
		Catalog Number	X	L	Catalog Number	X	L		
.781	CKB6	10.336.002	1.562	2.952	10.336.051	2.343	3.543	WC..04	WC..03
.812		10.336.003	1.625		10.336.052	2.436			
.845		10.336.004	1.690	3.150	10.336.053	2.535	3.937	WC..05	WC..04
.875		10.336.005	1.750		10.336.054	2.625			
.906		10.336.006	1.812		10.336.055	2.718			
.938		10.336.007	1.875	10.336.056	2.815	4.331			
.968		10.336.008	1.938		10.336.057		2.907		
1.000		—	2.000	3.543	10.336.058	3.000	4.528		
1.031		10.336.010	2.062		10.336.059	3.093			
1.063		10.336.011	2.125	3.937	—	3.189			
1.094		10.336.012	2.188		10.336.061	3.282	4.921		
1.125		10.336.013	2.250		—	3.375			
1.156		10.336.014	2.312	4.331	10.336.063	3.468	5.118	WC..06	
1.188		10.336.015	2.375		10.336.064	3.564			
1.219		10.336.016	2.438	4.921	10.336.065	3.657	6.299		
1.250		10.336.017	2.500		—	3.750			
1.312		10.336.018	2.625	5.512	10.336.067	3.938	7.087	WC..08	
1.375		10.336.019	2.750		10.336.068	4.125			
1.438		10.336.020	2.875	5.906	10.336.069	4.314	8.465		
1.500		10.336.021	3.000		10.336.070	4.500			
1.563		10.336.022	3.125	6.299	10.336.071	4.688	8.661		
1.625		10.336.023	3.250		10.336.072	4.875			
1.688		10.336.024	3.375	6.496	10.336.073	5.064	9.252		
1.750		10.336.025	3.500		10.336.074	5.250			
1.812		10.336.026	3.625	5.512	10.336.075	5.436	7.874		
1.875		10.336.027	3.750		10.336.076	5.625			
1.938		10.336.028	3.875	5.906	10.336.077	5.814	7.874		
2.000		10.336.029	4.000		10.336.078	6.000			
2.063		10.336.030	4.125	6.299	10.336.079	6.188	8.465		
2.125		10.336.031	4.250		—	6.375			
2.188		10.336.032	4.375	6.496	10.336.081	6.564	8.661		
2.250		10.336.033	4.500		10.336.082	6.750			
2.312		10.336.034	4.625	6.496	10.336.083	6.936	9.252		
2.375	10.336.035	4.750	10.336.084		7.125				
2.438	10.336.036	4.875	7.480	10.336.085	7.314	10.039			
2.500	10.336.037	5.000		10.336.086	7.500				
2.625	10.336.038	5.250	7.480	10.336.087	7.875	WC..10			
2.750	—	—	—	10.336.088	8.250				
2.875	10.336.040	5.750	8.268	10.336.089	8.625				

• Available as long as stock lasts

INDEXABLE INSERT DRILL—SERIES 337

INDEXABLE INSERT DRILL—SERIES 336

METRIC

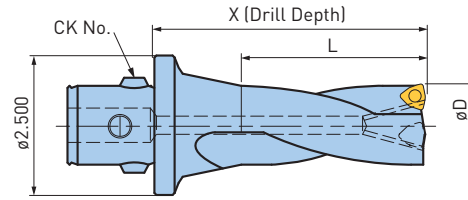
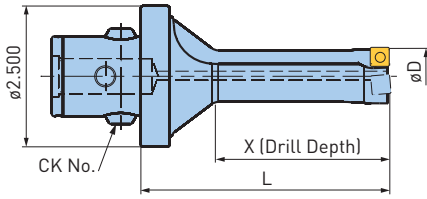

Drill øD	Indexable Drills 3xD				Indexable Drills 4xD				Inserts	
	Catalog Number	Reference Number	X	L	Catalog Number	Reference Number	X	L		
16	ID16-48CKB6	10.337.316	48	85	ID16-64CKB6	10.337.416	64	101	WP 337-1	
17	ID17-51CKB6	10.337.317	51	88	ID17-68CKB6	10.337.417	68	105		
18	ID18-54CKB6	10.337.318	54	91	ID18-72CKB6	10.337.418	72	109		
19	ID19-57CKB6	10.337.319	57	94	ID19-76CKB6	10.337.419	76	113		
20	ID20-60CKB6	10.337.320	60	97	ID20-80CKB6	10.337.420	80	117		
21	ID21-63CKB6	10.337.321	63	100	ID21-84CKB6	10.337.421	84	121	WP 337-2	
22	ID22-66CKB6	10.337.322	66	103	ID22-88CKB6	10.337.422	88	125		
23	ID23-69CKB6	10.337.323	69	106	ID23-92CKB6	10.337.423	92	129		
24	ID24-72CKB6	10.337.324	72	109	ID24-96CKB6	10.337.424	96	133		
25	ID25-75CKB6	10.337.325	75	112	ID25-100CKB6	10.337.425	100	137		
26	ID26-78CKB6	10.337.326	78	118	ID26-104CKB6	10.337.426	104	146	WP 337-3	
27	ID27-81CKB6	10.337.327	81	121	ID27-108CKB6	10.337.427	108	150		
28	ID28-84CKB6	10.337.328	84	124	ID28-112CKB6	10.337.428	112	154		
29	ID29-87CKB6	10.337.329	87	127	ID29-116CKB6	10.337.429	116	158		
30	ID30-90CKB6	10.337.330	90	130	ID30-120CKB6	10.337.430	120	162		
Indexable Drills 2xD					Indexable Drills 3xD					
31	ID31-62CKB6	10.336.631	62	100	ID31-93CKB6	10.336.731	93	130	WC..06	
32	ID32-64CKB6	10.336.632	64		ID32-96CKB6	10.336.732	96			
33	ID33-66CKB6	10.336.633	66		ID33-99CKB6	10.336.733	99			
34	ID34-68CKB6	10.336.634	68	110	ID34-102CKB6	10.336.734	102	140		
35	ID35-70CKB6	10.336.635	70		ID35-105CKB6	10.336.735	105			
36	ID36-72CKB6	10.336.636	72		ID36-108CKB6	10.336.736	108			
37	ID37-74CKB6	10.336.637	74		ID37-111CKB6	10.336.737	111			
38	ID38-76CKB6	10.336.638	76	125	ID38-114CKB6	10.336.738	114	160		
39	ID39-78CKB6	10.336.639	78		ID39-117CKB6	10.336.739	117			
40	ID40-80CKB6	10.336.640	80		ID40-120CKB6	10.336.740	120			
41	ID41-82CKB6	10.336.641	82	140	ID41-123CKB6	10.336.741	123	165		
42	ID42-84CKB6	10.336.642	84		ID42-126CKB6	10.336.742	126			
43	ID43-86CKB6	10.336.643	86		ID43-129CKB6	10.336.743	129			
44	ID44-88CKB6	10.336.644	88		ID44-132CKB6	10.336.744	132			
45	ID45-90CKB6	10.336.645	90	150	ID45-135CKB6	10.336.745	135	180		
47	ID47-94CKB6	10.336.647	94		ID47-141CKB6	10.336.747	141			
49	ID49-98CKB6	10.336.649	98		ID49-147CKB6	10.336.749	147			
51	ID51-102CKB6	10.336.651	102	160	ID51-153CKB6	10.336.751	153	200		
53	ID53-106CKB6	10.336.653	106		ID53-159CKB6	10.336.753	159			
55	ID55-110CKB6	10.336.655	110		ID55-165CKB6	10.336.755	165			
57	ID57-114CKB6	10.336.657	114	165	ID57-171CKB6	10.336.757	171	215		
59	ID59-118CKB6	10.336.659	118		ID59-177CKB6	10.336.759	177			
61	ID61-122CKB6	10.336.661	122		ID61-183CKB6	10.336.761	183			
									WC..10	

INDEXABLE INSERT DRILL—CARBIDE SELECTION CHART

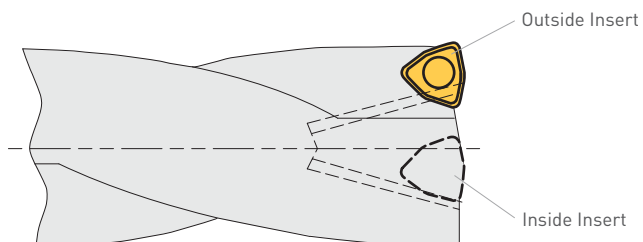

Material	Inside/Outside Insert-Series 336						Inside/Outside Insert-Series 337		
	WC..03	WC..04	WC..05	WC..06	WC..08	WC..10	337-1	337-2	337-3
Carbon Steels 10XX-15XX 1018, 1212, 1551	11.658.620	11.658.630	11.658.640	11.658.650	11.658.660	10.655.670	10.655.910	10.655.920	10.655.930
Alloy Steels 21XX-92XX 4130, 4340, 8620	11.658.620	11.658.630	11.658.640	11.658.650	11.658.660	10.655.670	10.655.910	10.655.920	10.655.930
300 Series Stainless Steels 304, 316, 17-4Ph	11.658.620	11.658.634/ 11.658.630	11.658.644/ 11.658.640	11.658.654/ 11.658.650	11.658.664/ 11.658.660	10.655.671	10.655.911	10.655.921	10.655.931
400 Series Stainless Steels Martensitic	11.658.620	11.658.634/ 11.658.630	11.658.644/ 11.658.640	11.658.654/ 11.658.650	11.658.664/ 11.658.660	10.655.671	10.655.912	10.655.922	10.655.932
Cast Iron Grey	11.658.624	11.658.634	11.658.644	11.658.654	11.658.664	10.655.671/ 10.655.670	10.655.912	10.655.922	10.655.932
Cast Iron Ductile/Nodular	11.658.624	11.658.634	11.658.644	11.658.654	11.658.664	10.655.671/ 10.655.670	10.655.911	10.655.921	10.655.931
Exotics Titanium, Inconel, etc.	11.658.620	11.658.634/ 11.658.630	11.658.644/ 11.658.640	11.658.654/ 11.658.650	11.658.664/ 11.658.660	10.655.671	10.655.913	10.655.923	10.655.933
Brass and Bronze	11.658.624	11.658.634	11.658.644	11.658.654	11.658.664	10.655.671	10.655.913	10.655.923	10.655.933
Aluminum and Non-Ferrous	11.658.624	11.658.634	11.658.644	11.658.654	11.658.664	10.655.671	10.655.913	10.655.923	10.655.933

INDEXABLE INSERT DRILL—SERIES 336 INSERTS

WC..03

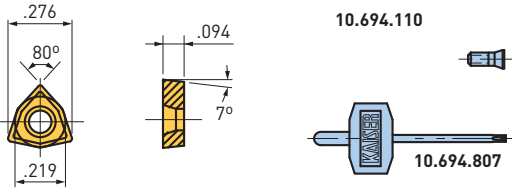

Catalog Number	Designation	Rake Angle	Radius	Grade
11.658.620	WC033115C6TNP15	15°	0.031	TN15
11.658.624	WC033115C2P	15°	0.031	C2

WC..04

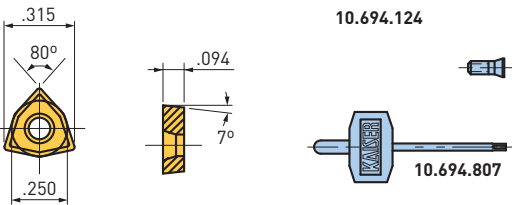

Catalog Number	Designation	Rake Angle	Radius	Grade
11.658.630	WC043115C6TNP15	15°	0.031	TN15
11.658.634	WC043115C2P	15°	0.031	C2

WC..05

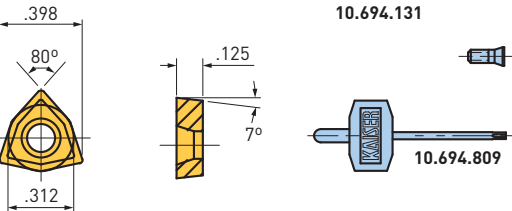

Catalog Number	Designation	Rake Angle	Radius	Grade
11.658.640	WC053115C6TNP15	15°	0.031	TN15
11.658.644	WC053115C2P	15°	0.031	C2

WC..06

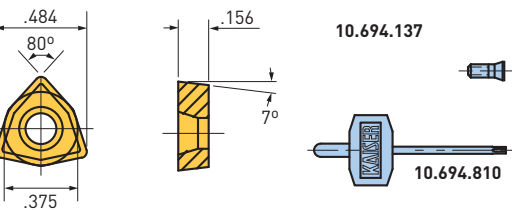

Catalog Number	Designation	Rake Angle	Radius	Grade
11.658.650	WC063115C6TNP15	15°	0.031	TN15
11.658.654	WC063115C2P	15°	0.031	C2

WC..08

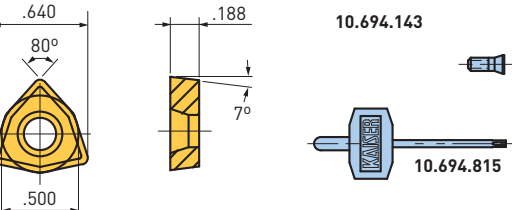

Catalog Number	Designation	Rake Angle	Radius	Grade
11.658.660	WC084715C6TNP15	15°	0.047	TN15
11.658.664	WC084715C2P	15°	0.047	C2

WC..10

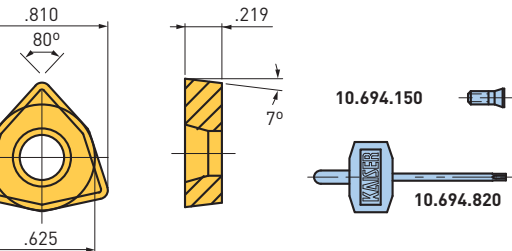

Catalog Number	Designation	Rake Angle	Radius	Grade
10.655.670	WC104715C6TNP15	15°	0.047	TN15
10.655.671	WC104715C2P	15°	0.047	C2

INDEXABLE INSERT DRILL—SERIES 337 INSERTS

WP 337-1

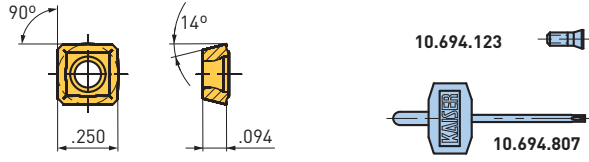

Catalog Number	Designation	Rake Angle	Grade
10.655.910	WP 337-1 16/20	15°	TNP11
10.655.911	WP 337-1 16/20	15°	TNP12
10.655.912	WP 337-1 16/20	15°	TNP16
10.655.913	WP 337-1 16/20	15°	C2P

WP 337-2

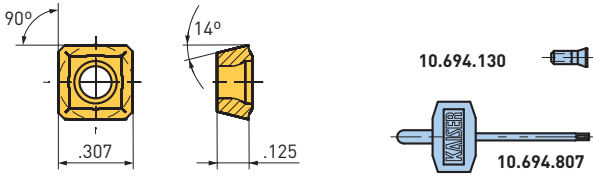

Catalog Number	Designation	Rake Angle	Grade
10.655.920	WP 337-2 21/25	15°	TNP11
10.655.921	WP 337-2 21/25	15°	TNP12
10.655.922	WP 337-2 21/25	15°	TNP16
10.655.923	WP 337-2 21/25	15°	C2P

WP 337-3

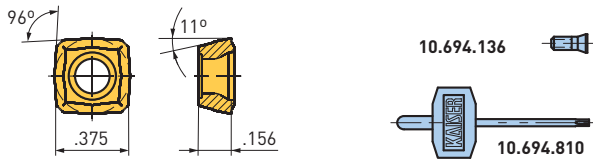

Catalog Number	Designation	Rake Angle	Grade
10.655.930	WP 337-3 26/30	15°	TNP11
10.655.931	WP 337-3 26/30	15°	TNP12
10.655.932	WP 337-3 26/30	15°	TNP16
10.655.933	WP 337-3 26/30	15°	C2P

INDEXABLE INSERT DRILL—CUTTING DATA

Material	Cutting Speed SFM		Feed IPR				
	Coolant Delivery		Drill Diameter				
	Flood	Through Tool	≤ø.812	ø.845-1.000	ø1.031-1.188	ø1.219-1.688	ø1.750 & Over
Carbon Steel 10XX-15XX, 1018, 1212, 1551	250-400	575-800	.0020	.0040	.0050	.006	.0080
Alloy Steel 21XX-92XX, 4130, 4340, 8620	230-350	550-700	.0020	.0040	.0050	.006	.0080
300 Series Stainless Steel 304, 316, 17-4Ph	230-350	450-580	.0025	.0030	.0035	.004	.0045
400 Series Stainless Steel 410, 430	230-350	490-620	.0025	.0030	.0035	.004	.0045
Grey Cast Iron	250-360	600-750	.0040	.0055	.0060	.007	.0080
Ductile/Nodular Cast Iron	230-270	460-590	.0040	.0055	.0060	.007	.0080
Aluminum & Non-Ferrous	325-400	650-1150	.0060	.0085	.0085	.010	.0120

Cutting Speed:
 $RPM = \frac{SFM \times 3.82}{Drill \ \phi}$

Feed Rate:
 $IPM = RPM \times IPR$

K VALUES

Carbon Steel	Alloy Steel	Stainless Steel	Grey Cast Iron	Ductile/Nodular Cast Iron	Aluminum & Non-Ferrous
1.6	1.3	1	1.7	1.5	3.4

$$hP = \frac{(.785)[D^2](RPM)(IPR)}{K}$$

HORSE POWER REQUIREMENTS

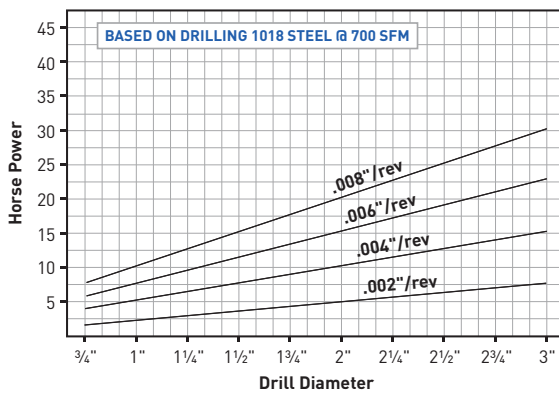

THRUST REQUIREMENTS

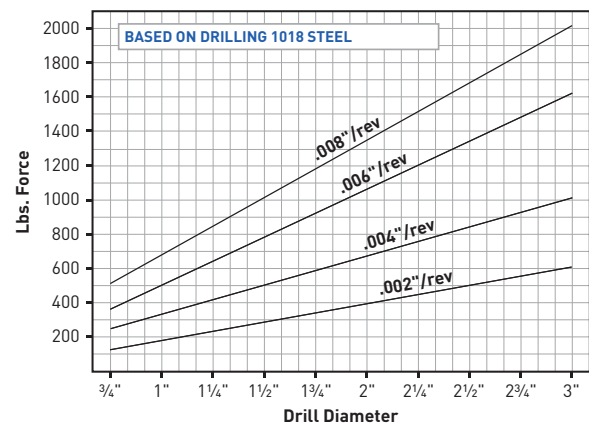

COOLANT REQUIREMENTS*

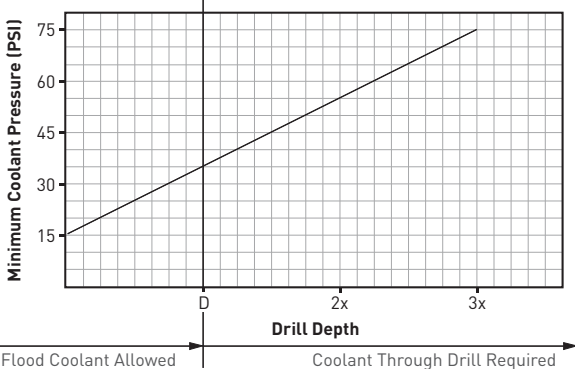

COOLANT VOLUME*

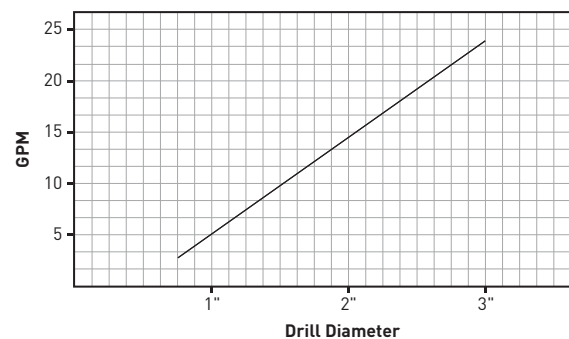

*For coolant requirements and coolant volume, add 10-20% for vertical drilling operations

CAUTION ⚠

A disc is generated during through-boring operations. In case of rotating workpieces, there is an accident hazard due to the development of centrifugal force. Therefore, always work with safety guards.



ADJUSTABLE DRILL HOLDERS— CAT40/50 CKB HOLDER (ASME B5.50)

For Diameter Adjustment of Indexable Insert Drills

- Accurate, easy-to-read adjusting collar gives ± 0.004 "/div. adjusting precision which can be split for ± 0.002 "/div. or better
- Extremely compact and rigid design for drilling under all conditions
- One holder suitable for ± 0.748 " - 2.500"
- Wide adjustment range: Nominal drill ± 0.040 ", -0.008 "

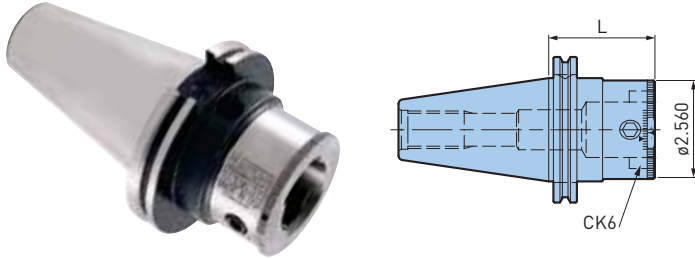

Catalog Number	Reference Number	L
CV40-ADH-CKB6	11.336.311	3.189
CV50-ADH-CKB6	11.336.313	2.716
BT40-ADH-CKB6	10.336.302	2.008
BT50-ADH-CKB6	10.336.304	2.835
HSK-A63-ADH-CKB6	10.336.309	2.756
HSK-A100-ADH-CKB6	10.336.310	3.268

STATIONARY DRILLING

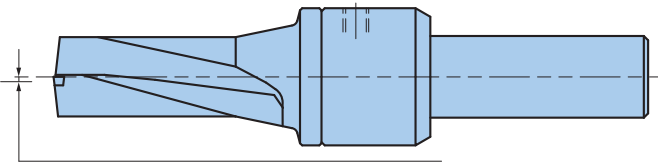

Max .0015" to the Middle Axis of the Spindle

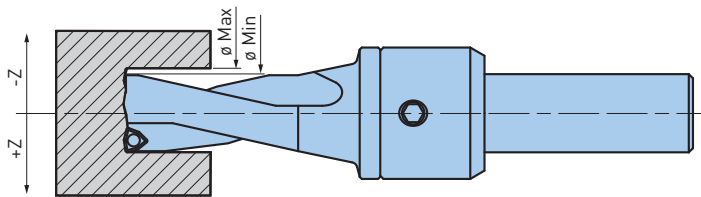

CAUTION ⚠

Indexable Insert Drills rotate clockwise.
Check direction of rotation.

OFF-AXIS USE OF INDEXABLE INSERT DRILLS
SERIES 337

Insert Size	Drill øD	Adjustable Range		Bore Diameter	
		-Z	+Z	Min	Max
WP 337-1	16mm	N/A	1.7mm	16mm	19.4mm
	17mm		1.5mm	17mm	20mm
	18mm		1.3mm	18mm	20.6mm
	19mm		1mm	19mm	21mm
	20mm		.8mm	20mm	21.6mm
WP 337-2	21mm		2mm	21mm	25mm
	22mm		1.7mm	22mm	25.4mm
	23mm		1.5mm	23mm	26mm
	24mm		1.2mm	24mm	26.4mm
	25mm		1mm	25mm	27mm
WP 337-3	26mm		1.7mm	26mm	29.4mm
	27mm		1.4mm	27mm	29.8mm
	28mm		1.2mm	28mm	30.4mm
	29mm		.9mm	29mm	30.8mm
	30mm		.7mm	30mm	31.4mm

OFF-AXIS USE OF INDEXABLE INSERT DRILLS
SERIES 336

Insert Size	Drill øD	Adjustable Range		Bore Diameter	
		-Z	+Z	Min	Max
WC..03	.750	.010	.060	.730	.870
	.781	.010	.050	.761	.881
	.812	.010	.040	.792	.892
WC..04	.845	.010	.080	.825	1.005
	.875	.010	.070	.855	1.015
	.906	.010	.060	.886	1.026
	.938	.010	.050	.918	1.038
	.968	.010	.040	.948	1.048
WC..05	1.000	.010	.030	.980	1.060
	1.031	.010	.100	1.011	1.231
	1.063	.010	.090	1.043	1.243
	1.094	.010	.080	1.074	1.254
	1.125	.010	.070	1.105	1.265
	1.156	.010	.060	1.136	1.276
	1.188	.010	.050	1.168	1.288
	1.219	.010	.140	1.199	1.499
	1.250	.010	.130	1.230	1.510
	1.312	.010	.120	1.292	1.552
WC..06	1.375	.010	.100	1.355	1.575
	1.438	.010	.080	1.418	1.598
	1.500	.010	.070	1.480	1.640
	1.563	.010	.050	1.543	1.663
	1.625	.010	.040	1.605	1.705
	1.688	.010	.020	1.668	1.728
	1.750	.020	.150	1.710	2.050
	1.812	.020	.140	1.772	2.092
WC..08	1.875	.020	.130	1.835	2.135
	1.938	.020	.120	1.898	2.178
	2.000	.020	.100	1.960	2.200
	2.063	.020	.080	2.023	2.223
	2.125	.020	.070	2.085	2.265
	2.188	.020	.050	2.148	2.288
	2.250	.020	.040	2.210	2.330
	2.312	.020	.020	2.272	2.352
	2.375	.020	.010	2.335	2.395
	2.438	.020	.160	2.398	2.758
WC..10	2.500	.020	.150	2.460	2.800
	2.625	.020	.120	2.585	2.865
	2.750	.020	.090	2.710	2.930
	2.875	.020	.060	2.835	2.995
	3.000	.020	.030	2.960	3.060

SPADE DRILL—HOLDERS & BLADES

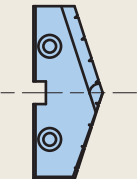
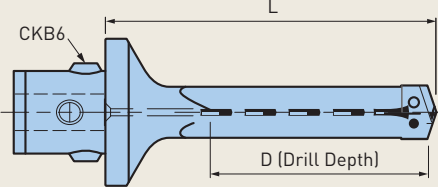
					
+0.005 -0.000					
Drill Diameter	HSS Grade	SC Grade	4 x Diameter	L	D Max
.531	—	11.341.025	11.340.604 Designation KSD 0x13-17/62xCK6 Insert Screw 11.341.901	4.790	2.438
.562	—	11.341.026			
.594	—	11.341.027			
.625	—	11.341.028	11.340.614 Designation KSD 0.5x15-17/62xCK6 Insert Screws 11.341.902	4.790	2.438
.656	—	11.341.029			
.688	—	11.341.030			
.719	11.341.101	11.341.125	11.340.624 Designation KSD 1x18-24/84xCK6 Insert Screws 11.341.902	5.800	3.312
.750	11.341.102	11.341.126			
.781	11.341.103	11.341.127			
.812	11.341.104	11.341.128			
.844	11.341.105	11.341.129			
.875	11.341.106	11.341.130			
.906	11.341.107	11.341.131	11.340.634 Designation KSD 1.5x22-24/84xCK6 Insert Screws 11.341.904	5.800	3.312
.934	11.341.108	11.341.132			
1.000	11.341.202	11.341.226	11.340.644 Designation KSD 2x25-35/119xCK6 Insert Screws 11.341.905	7.180	4.688
1.062	11.341.204	11.341.228			
1.125	11.341.206	11.341.230			
1.188	11.341.208	11.341.232	11.340.654 Designation KSD 2.5x30-35/119xCK6 Insert Screws 11.341.905	7.180	4.688
1.250	11.341.210	11.341.234			
1.312	11.341.212	11.341.236			
1.375	11.341.214	11.341.238			
1.438	11.341.302	11.341.326			
1.500	11.341.304	11.341.328	11.340.664 Designation KSD 3x36-47/167xCK6 Insert Screws 11.341.906	9.650	6.562
1.562	11.341.306	11.341.330			
1.625	11.341.308	11.341.332			
1.688	11.341.310	11.341.334			
1.750	11.341.312	11.341.336			
1.812	11.341.314	11.341.338			
1.875	11.341.316	11.341.340			
2.000	11.341.404	11.341.428	11.340.674 Designation KSD 4x48-65/227xCK6 Insert Screws 11.341.906	12.060	8.938
2.125	11.341.408	11.341.432			
2.250	11.341.412	11.341.436			
2.375	11.341.416	11.341.440			
2.500	11.341.420	11.341.444			

SPADE DRILL—APPLICATION GUIDELINES

Material	Material Hardness (BHN)	SFM	Feed (IPR)				
			.531"-.688"	.688"-1.000"	1.000"-1.250"	1.250"-2.000"	2.000"-2.500"
Free Machining Steel 1118, 1215, 12L14, etc.	100-150	200	.010	.013	.016	.020	.025
	150-200	180	.010	.013	.016	.020	.025
	200-250	160	.010	.013	.016	.020	.025
Low Carbon Steel 1010, 1020, 1025, 1522, 1144, etc.	85-125	170	.009	.012	.015	.020	.025
	125-175	160	.009	.012	.015	.020	.025
	175-225	150	.008	.010	.014	.018	.022
	225-275	140	.008	.010	.014	.018	.022
Medium Carbon Steel 1030, 1040, 1050, 1527, 1140, 1151, etc.	125-175	160	.009	.012	.015	.020	.025
	175-225	150	.008	.010	.014	.018	.022
	225-275	140	.008	.010	.014	.018	.022
	275-325*	130	.007	.009	.012	.016	.020
Alloy Steel 4140, 5140, 8640, etc.	125-175	150	.008	.010	.014	.017	.020
	175-225	140	.008	.010	.014	.017	.020
	225-275	130	.007	.010	.014	.017	.020
	275-325*	120	.006	.009	.012	.015	.018
	325-375*	110	.006	.009	.012	.015	.018
High Strength Alloy 4340, 4330V, 300M, etc.	225-300*	80	.007	.009	.010	.014	.018
	300-350*	60	.007	.009	.010	.014	.018
	350-400*	50	.006	.008	.009	.012	.016
Structural Steel A36, A285, A516, etc.	100-150	140	.010	.012	.014	.018	.022
	150-250	120	.009	.010	.012	.016	.020
	250-350*	100	.008	.009	.010	.014	.017
High Temp. Alloy Hastelloy B, Inconel 600, etc.	140-220*	30	.007	.008	.010	.012	.015
	220-310*	25	.006	.007	.080	.010	.012
Stainless Steel 310, 316, 330, 17-4 PH, etc.	135-185	75	.008	.009	.011	.014	.016
	185-275	60	.007	.008	.010	.012	.014
Tool Steel H-13, H-21, A-4, O-2, S-3, etc.	150-200	80	.006	.008	.010	.012	.015
	200-250	60	.006	.008	.010	.012	.015
Aluminum	30	600	.013	.016	.022	.030	.035
	180	300	.013	.016	.022	.030	.035
Cast Iron (TiN Coated HSS Tools)	120-150	170	.012	.016	.020	.024	.028
	150-200	150	.011	.014	.018	.022	.026
	200-220	130	.009	.012	.016	.018	.022
	220-260*	110	.007	.009	.012	.014	.017
	260-320*	90	.006	.007	.009	.011	.014

*SC grade recommended

- Reductions in speed may be required due to excessive tool wear
- Always use an ample supply of coolant through the tool

Formulas: $IPM = RPM \times IPR$ $SFM = \frac{RPM \times \text{Drill } \phi}{3.82}$ $RPM = \frac{SFM \times 3.82}{\text{Drill } \phi}$

The speeds and feeds listed above are only a starting point! Contact our engineering department if you require assistance. Please have item number, hole diameter, depth, material grade, BHN hardness and coolant pressure information available when you call. Additional information such as part and machine rigidity, horse power and thrust limits, vertical or horizontal spindle, revolving or stationary tool, flood or through holder coolant are also very helpful to our Application Engineers when you require their best recommendation.

The above recommendations are based on adequate coolant flow, machine rigidity, horse power and thrust capability.

Wear protective eye glasses and use machine protective shields.

FULLCUT MILL—TYPE FCR, INCH STYLE (ASME B5.50-1994)

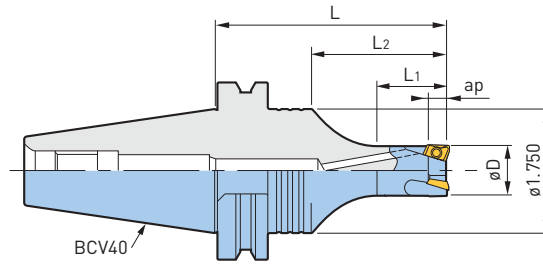

Catalog Number	øD	ap	L	L1	L2	No. of Inserts	Insert Model	Weight (lbs.)
BCV40-FCR.625-3.5	.625	.315	3.500	1.000	2.120	2	BRG160808	2.9
-5			5.000	1.250	3.620			3.3
-5.5			5.500	1.000	4.120			3.5
-FCR.750-3.5	.750	.315	3.500	1.250	2.120	3	BRG200808	2.7
-5			5.000	1.500	3.620			3.5
-5.5			5.500	1.250	4.120			3.8
-FCR1.000-3.5	1.000	.315	3.500	1.500	2.120	3	BRG250808	2.9
-5			5.000	1.750	3.620			3.5
-5.5			5.500	1.500	4.120			4.0
-FCR1.250-3.5	1.250	.394	3.500	1.750	2.120	3	BRG3210□□	3.1
-5			5.000	2.000	3.620			3.8
-5.5			5.500	1.500	4.120			4.2

- ap = length of effective cutting edge
- Inserts must be ordered separately

ACCESSORIES



50 TAPER SHANK ADAPTER

Catalog Number	L
BCV50-BCV40-2	1.969
-4	3.543

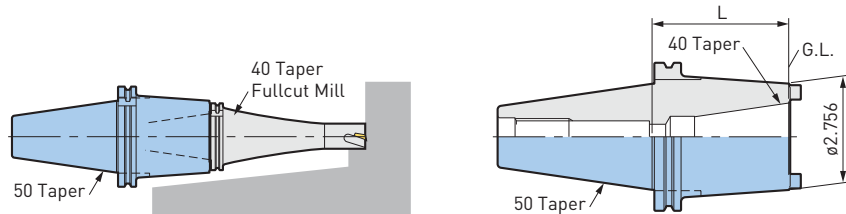

FULLCUT MILL—TYPE FCR, METRIC STYLE (MAS 403)

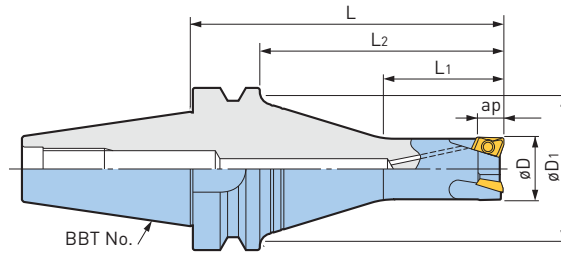

Catalog Number	øD	øD1	ap	L	L1	L2	No. of Inserts	Insert Model	Weight (lbs.)
BBT30-FCR16082-65	16mm (.630)	1.575	.315	2.559	1.102	1.693	2	BRG160808	1.1
-FCR20083-65	20mm (.787)			2.559	1.102	1.693		BRG200808	1.1
-FCR25083-65	25mm (.984)			2.559	1.299	1.693	3	BRG250808	1.2
-FCR32103-65	32mm (1.260)			.394	2.559	1.575		1.693	BRG3210□□
BBT40-FCR16082-85	16mm (.630)	2.362	.315	3.346	.984	2.283	2	BRG160808	2.9
-120				4.724	1.181	3.661			3.3
-135				5.315	.984	4.252			3.5
-FCR20083-85	20mm (.787)	2.362	.315	3.346	1.378	2.283	3	BRG200808	2.7
-120				4.724	1.181	3.661			3.5
-135				5.315	1.181	4.252			3.8
-FCR25083-85	25mm (.984)	2.362	.315	3.346	1.575	2.283	3	BRG250808	2.9
-120				4.724	1.772	3.661			3.5
-135				5.315	1.378	4.252			4.0
-FCR32103-85	32mm (1.260)	2.362	.394	3.346	1.772	2.283	3	BRG3210□□	3.1
-120				4.724	1.969	3.661			3.8
-135				5.315	1.575	4.252			4.2

- ap = length of effective cutting edge
- Inserts must be ordered separately

ACCESSORIES



50 TAPER SHANK ADAPTER

Catalog Number	L
BBT50-BBT40-50	1.969
-90	3.543

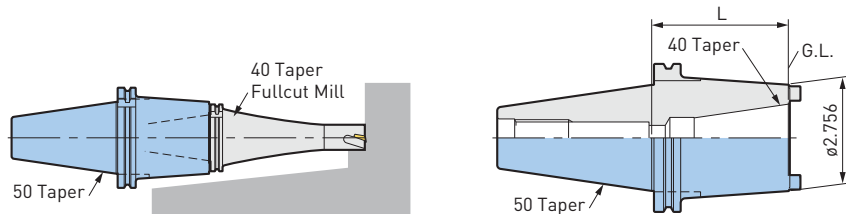

FULLCUT MILL—TYPE FCR LONG NOSE, METRIC STYLE (MAS 403)

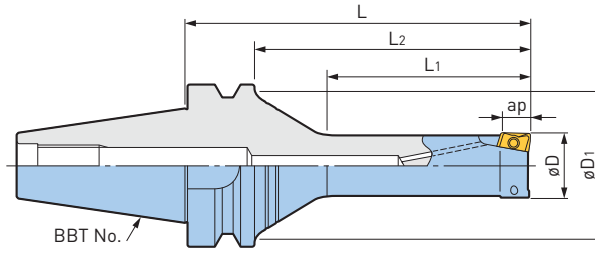

Catalog Number	øD	øD1	ap	L	L1	L2	No. of Inserts	Insert Model	Weight (lbs.)
BBT30-FCR16082L-85	16mm (.630)	1.575	.315	3.346	1.772	2.480	2	BRG160808	.2
-FCR20082L-85	20mm (.787)			3.346	1.969	2.480		BRG200808	.2
-FCR25082L-85	25mm (.984)			3.346	1.969	2.480		BRG250808	.3
-FCR32102L-85	32mm (1.260)			3.346	2.362	2.480		BRG3210□□	.3
BBT40-FCR16082L-105	16mm (.630)	2.362	.315	4.134	1.772	3.071	2	BRG160808	.6
-120				4.724	1.772	3.661			.6
-FCR20082L-120	20mm (.787)	2.362	.315	4.724	2.362	3.661	2	BRG200808	.6
-135				5.315	2.362	4.252			.7
-FCR25082L-135	25mm (.984)	2.362	.315	5.315	2.953	4.252	2	BRG250808	.7
-150				5.906	2.953	4.843			.8
-FCR32102L-135	32mm (1.260)	2.362	.394	5.315	3.150	4.252	2	BRG3210□□	.8
-150				5.906	3.543	4.843			.9

- ap = length of effective cutting edge
- Inserts must be ordered separately

ACCESSORIES



50 TAPER SHANK ADAPTER

Catalog Number	L
BBT50-BBT40-50	1.969
-90	3.543

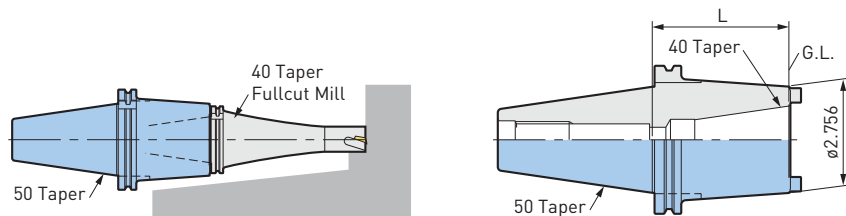

FULLCUT MILL—TYPE FCR, METRIC STYLE (HSK)

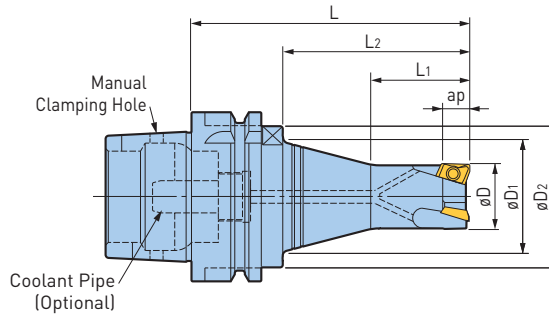

Catalog Number	øD	øD1	øD2	ap	L	L1	L2	No. of Inserts	Insert Model	Weight (lbs.)
HSK-A50-FCR16082-75	16mm [.630]	1.260	1.654	.315	2.953	1.063	1.614	2	BRG160808	1.1
-FCS20083-75	20mm [.787]				2.953	1.102	1.614	3	BRG200808	1.3
-FCS25083-75	25mm [.984]				2.953	1.299	1.614		BRG250808	1.3
-FCS32103-75	32mm [1.260]				1.319	.394	2.953		1.535	1.614
HSK-A63-FCR16082-85	16mm [.630]	1.772	2.087	.315	3.346	.984	2.008	2	BRG160808	2.0
-120					4.724	1.181	3.386			2.4
-135					5.315	.984	3.976			2.6
-FCR20083-85	20mm [.787]	1.772	2.087	.315	3.346	1.260	2.008	3	BRG200808	2.2
-120					4.724	1.181	3.386			2.6
-135					5.315	1.181	3.976			2.9
-FCR25083-85	25mm [.984]	1.772	2.087	.315	3.346	1.378	2.008	3	BRG250808	2.2
-120					4.724	1.772	3.386			2.6
-135					5.315	1.378	3.976			3.1
-FCR32103-85	32mm [1.260]	1.772	2.087	.394	3.346	1.575	2.008	3	BRG3210□□	2.4
-120					4.724	1.969	3.386			3.1
-135					5.315	1.575	3.976			3.3

- ap = length of effective cutting edge
- Coolant Pipe & Inserts must be ordered separately

ACCESSORIES



FULLCUT MILL—TYPE FCR LONG NOSE, METRIC STYLE (HSK)

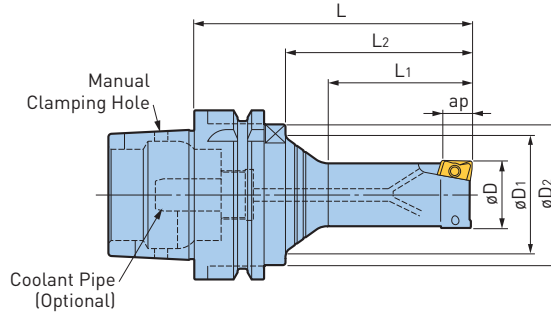

Catalog Number	øD	øD1	øD2	ap	L	L1	L2	No. of Inserts	Insert Model	Weight (lbs.)
HSK-A63-FCR16082L-85	16mm (.630)	1.772	2.087	.315	3.346	1.575	2.008	2	BRG160808	2.0
-120					4.724	1.771	3.386			2.2
-FCR20082L-105	20mm (.787)	1.772	2.087	.315	4.134	1.969	2.795	2	BRG200808	2.4
-120					4.724	2.362	3.386			2.6
-FCR25082L-105	25mm (.984)	1.772	2.087	.315	4.134	2.165	2.795	2	BRG250808	2.4
-120					4.724	2.559	3.386			2.4
-FCR32102L-120	32mm (1.260)	1.772	2.087	.394	4.724	2.756	3.386	2	BRG3210□□	3.1
-135					5.315	3.150	3.976			3.1

- ap = length of effective cutting edge
- Coolant Pipe & Inserts must be ordered separately

ACCESSORIES



COOLANT PIPE

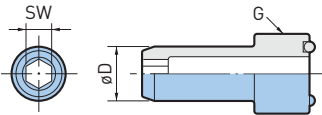

MONO BLOCK TYPE

Catalog Number	øD	G	SW	
HSK40-CP	.315	M12xP1	4mm	
HSK50-CP	.394	M16xP1	5mm	
HSK63-CP	.472	M18xP1	6mm	

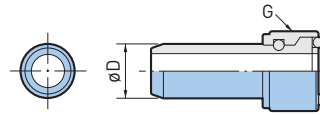

1° SWING TYPE

Catalog Number	øD	G	Wrench	
HSK40-CPM	.315	M12xP1	CPW40	
HSK50-CPM	.394	M16xP1	CPW50	
HSK63-CPM	.472	M18xP1	CPW63	

CAUTION

DIN standard specifies ±1 degree of float. For proper installation, the special wrench is necessary. For machines capable of supplying coolant through the spindle, the Coolant Pipe should be fitted to all HSK holders to protect against accidental selection of coolant.

FULLCUT MILL—TYPE FCR STRAIGHT SHANK, INCH STYLE

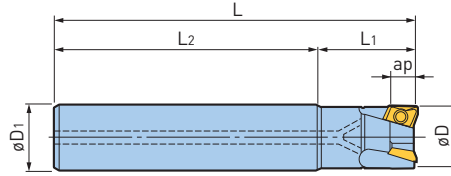

Catalog Number	øD	øD1	ap	L	L1	L2	No. of Inserts	Insert Model	Weight (lbs.)
ST.750-FCR.750-4	.750	.750	.315	4.000	1.250	2.750	3	BRG200808	.5
ST1.000-FCR1.000-5	1.000	1.000	.315	5.000	1.500	3.500	3	BRG250808	1.1
ST1.250-FCR1.250-5	1.250	1.250	.394	5.000	1.500	3.500	3	BRG3210□□	1.7

- ap = length of effective cutting edge
- Inserts must be ordered separately

ACCESSORIES



FULLCUT MILL—TYPE FCR OVERSIZE, METRIC STYLE

Cutter diameter is ø1mm larger than the shank diameter to avoid any interference with the workpiece.

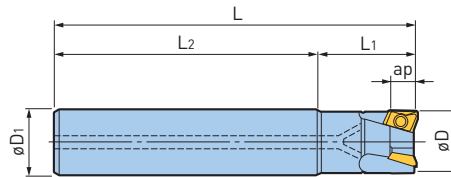

CUTTER DIAMETER

$\text{øD} = \text{øD1} + 1\text{mm}$

Catalog Number	øD	øD1	ap	L	L1	L2	No. of Inserts	Insert Model	Weight (lbs.)
ST15-FCR16082-120	16mm [.630]	15mm [.591]	.315	4.724	.984	3.740	2	BRG160808	.4
ST16-FCR17082-120	17mm [.670]	16mm [.630]	.315	4.724	.984	3.740	2	BRG160808	.4
ST19-FCR20082-165	20mm [.787]	19mm [.748]	.315	6.496	1.181	5.315	2	BRG200808	.9
-FCR20083-135				5.315		3	.7		
ST20-FCR21082-165	21mm [.827]	20mm [.787]	.315	6.496	1.181	5.315	2	BRG200808	.9
-FCR21083-135				5.315		3	.7		
ST24-FCR25082-180	25mm [.984]	24mm [.945]	.315	7.087	1.378	5.709	2	BRG250808	1.5
-FCR25083-150				5.906		3	1.3		
ST25-FCR26082-165	26mm [1.024]	25mm [.984]	.315	6.496	1.496	5.000	2	BRG250808	1.3
-FCR26083-150				5.906		3	1.3		
ST28-FCR32102-180	32mm [1.260]	28mm [1.102]	.394	7.087	1.890	5.197	2	BRG3210oo	2.4
-FCR32103-180				7.087		3	2.2		
ST32-FCR33102-180	33mm [1.299]	32mm [1.260]	.394	7.087	1.890	5.197	2	BRG3210□□	2.4
-FCR33103-180				7.087		3	2.2		

- ap = length of effective cutting edge
- Inserts must be ordered separately

ACCESSORIES



FULLCUT MILL—TYPE FCR INDEXABLE INSERTS



INSERT CLASSIFICATIONS

ISO Material	Grade	Material	Coating
P30	ACP300	General Steel	TiAlN / TiCN
M30	ACM300F	Stainless Steel	
K10	ACZ310	Cast Iron	
N20	DS20	Aluminum	DLC

MARKING DESCRIPTION

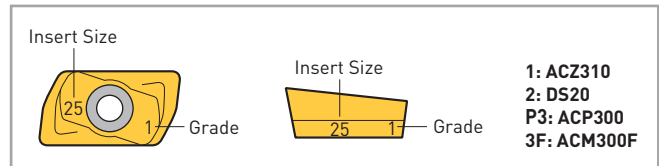

Cutter Dia.		Insert Model	Effective Cutting Length (ap)	Nose Radius	P	M	K	N
in	mm				ACP300	ACM300F	ACZ310	DS20
						Cast Iron	Aluminum	
.625	16-17	BRG160808	.315	.031	○	○	○	○
.750	20-21	BRG200808			○	○	○	○
1.000	25-26	BRG250808			○	○	○	○
1.250	32-33	BRG321008	.394	.031	○	○	○	○
		BRG321032		.125	—	—	—	○

- Inserts are available in packages of 10 pcs.
- Please clarify the insert model and grade when ordering (ex: BRG160808ACZ350S)

CAUTION

Fullcut Mill uses a different insert for each cutter diameter and if an incorrect insert is used, a problem will result. There is no compatibility with those of Type FCM.

FULLCUT MILL—TYPE FCR SPARE PARTS

Cutter Dia.		Insert Model	Insert Clamping Screw Set (10 Screws & 1 Wrench)	Wrench
in	mm		Catalog Number	Catalog Number
.625	16-17	BRG160808	 S2506DS	 DA-T8
.750	20-21	BRG200808		
1.000	25-26	BRG250808		
1.250	32-33	BRG3210□□	S3508DS	DA-T15

- It is recommended to regularly replace clamping screws and wrench to ensure the correct clamping force is maintained

CUTTING DATA FULLCUT MILL—TYPE FCR
RAMPING AND HELICAL INTERPOLATION

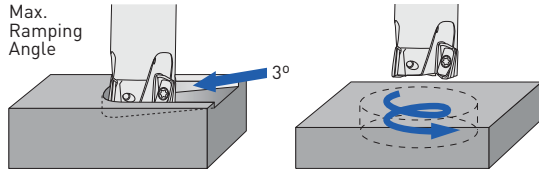

øD (mm)	Flat Bottom		Through Hole
	Max Hole ø	Min Hole ø	Min Hole ø
.625 (16)	1.181	1.063	.866
.750 (20)	1.496	1.417	1.142
1.000 (25)	1.890	1.772	1.535
1.250 (32)	2.441	2.323	1.890

øD (mm)	Work Material	Carbon Steel Alloy Steel	Unalloyed Steel	Prehardened Steel <HRC40	Stainless Steel	Die Steel	Cast Iron	Aluminum
	Insert Grade	ACP300		ACM300F			ACZ310	DS20
	Cutting Fluid	Dry		Dry	Dry	Dry		Dry/Wet
.630 (16) .669 (17)	Speed (SFM)	330-655	490-720	195-260	330-490	195-260	330-590	655-3280
	Feed (IPT)	.002-.005	.002-.005	.002-.003	.003-.006	.002-.004	.003-.007	.002-.009
.750 (20) 1.024 (26)	Speed (SFM)	330-655	490-655	195-330	395-490	195-330	330-590	655-3280
	Feed (IPT)	.003-.080	.003-.008	.002-.004	.005-.008	.002-.004	.001-.007	.004-.014
1.250 (32) 1.299 (33)	Speed (SFM)	330-655	490-655	195-330	395-490	195-395	330-590	655-3280
	Feed (IPT)	.003-.0080	.003-.008	.002-.004	.005-.008	.003-.005	.002-.008	.004-.014

SHOULDERING AND SLOTTING



øD (mm)	Work Material	Carbon Steel Alloy Steel	Unalloyed Steel	Prehardened Steel <HRC40	Stainless Steel	Die Steel	Cast Iron	Aluminum
	Insert Grade	ACP300		ACM300F			ACZ310	DS20
	Cutting Fluid	Dry		Dry	Dry	Dry		Dry/Wet
.625 (16) .827 (21)	Speed (SFM)	330-655	330-655	195-260	395-590	260-395	330-590	655-3280
	Feed (IPT)	.003-.007	.003-.007	.002-.004	.005-.007	.003-.005	.003-.007	.004-.012
1.000 (25) 1.299 (33)	Speed (SFM)	330-655	330-655	195-330	395-590	260-395	330-590	655-4920
	Feed (IPT)	.003-.008	.003-.008	.002-.004	.005-.008	.003-.005	.003-.008	.004-.014

PLUNGE MILLING

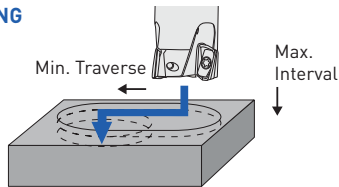

øD (mm)	Max. Interval	Min. Traverse
.625 (16)	.0197	.551
.750 (20)	.0394	.709
1.000 (25)	.0394	.906
1.250 (32)	.0787	1.181

øD (mm)	Work Material	Carbon Steel Alloy Steel	Unalloyed Steel	Prehardened Steel <HRC40	Stainless Steel	Die Steel	Cast Iron	Aluminum
	Insert Grade	ACP300		ACM300F			ACZ310	DS20
	Cutting Fluid	Dry/Air Blow		Dry/Air Blow	Dry/Air Blow	Dry/Air Blow		Air/Wet
.630 (16) .669 (17)	Speed (SFM)	260-395	260-395	197	260-395	197-262	260-525	655-1150
	Feed (IPR)	.002-.004	.002-.004	.001-.002	.002-.003	.002-.003	.002-.004	.002-.004
.750 (20) 1.024 (26)	Speed (SFM)	330-525	330-525	197-328	330-525	197-328	260-590	655-1640
	Feed (IPR)	.004-.001	.004-.001	.004-.001	.005-.001	.004-.008	.003-.012	.004-.012
1.250 (32) 1.299 (33)	Speed (SFM)	330-525	330-525	197-328	330-525	197-328	260-590	655-1970
	Feed (IPR)	.004-.012	.004-.012	.001-.012	.0047-.0118	.004-.008	.003-.016	.004-.012

CAUTION ⚠

The tables are just a reference to determine cutting conditions and it should be adjusted according to the condition of a machine tool or workpiece. When a long projection length model is used, it is necessary to lower the feed rate. Since chips may scatter, utilize safety enclosures. Do not use oil-based cutting fluid, or a fire may take place.

FULLCUT MILL—TYPE FCM, INCH STYLE (ASME B5.50-1994)

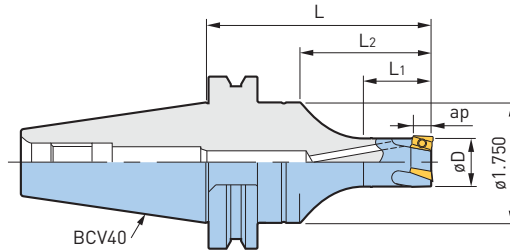

Catalog Number	øD	ap	L	L1	L2	No. of Inserts	Insert Model	Weight (lbs.)
BCV40-FCM.625-3	.625	.354	3.000	1.000	1.620	2	ARG1609□□	2.6
-4			4.000	1.250	2.620			2.9
-5			5.000	1.000	3.620			3.1
-FCM.750-3	.750	.354	3.000	1.000	1.620	3	ARG2009□□	2.6
-4			4.000	1.250	2.620			2.9
-5			5.000	1.000	3.620			3.1
-FCM1.000-3	1.000	.354	3.000	1.000	1.620	3	ARG2509□□	2.6
-5			5.000	1.750	3.620			3.5
-FCM1.250-3	1.250	.433	3.000	1.250	1.620	3	ARG3211□□	2.9
-5			5.000	2.250	3.620			3.7
-FCM1.500-3	1.500	.433	3.000	1.500	1.620	4	ARG4011□□	3.1
-5			5.000	2.500	3.620			4.4
-FCM2.000-3	2.000	.433	3.000	2.250	—	5		3.5

- ap = length of effective cutting edge
- Inserts must be ordered separately

ACCESSORIES



50 TAPER SHANK ADAPTER

Catalog Number	L
BCV50-BCV40-2	1.969
-4	3.543

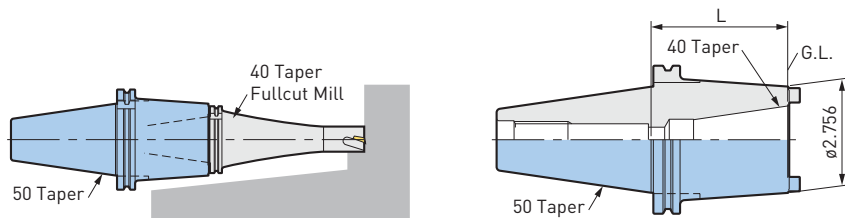

FULLCUT MILL—TYPE FCM, INCH & METRIC STYLE (MAS 403)

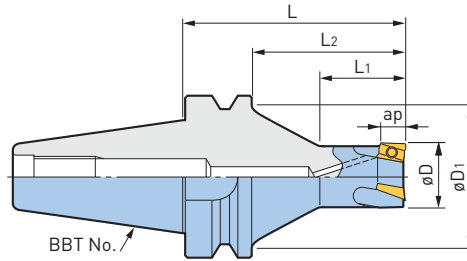

Catalog Number	øD	øD1	ap	L	L1	L2	No. of Inserts	Insert Model	Weight (lbs.)
BBT30-FCM.625-2.5	.625	1.575	.354	2.500	1.000	1.634	2	ARG1609□□	1.1
-FCM.750-2.5	.750			2.500	1.250	1.634		ARG2009□□	1.1
-FCM1.000-2.5	1.000			3	2.500	1.250	1.634	ARG2509□□	1.2
-FCM1.250-2.5	1.250				2.500	1.500	1.634	ARG3211□□	1.3
-FCM1.500-2	1.500	1.445	.433	2.000	1.000	1.110	4	ARG4011□□	1.3
-FCM2.000-2	2.000	1.800	2.000	1.000	1.110	5		1.6	
-FCM16092-65	16mm (.630)	1.525	.354	2.559	.906	1.693	2	ARG1609□□	1.1
-FCM20093-65	20mm (.787)			2.559	1.102	1.693		ARG2009□□	1.1
-FCM25093-65	25mm (.984)			2.559	1.299	1.693	3	ARG2509□□	1.2
-FCM32113-65	32mm [1.260]	1.614	2.559	1.496	1.693	ARG3211□□		1.3	
-FCM40114-50	40mm [1.575]	1.811	.433	1.969	.984	1.102	4	ARG4011□□	1.3
-FCM50115-50	50mm [1.969]			1.969	1.102	1.102			5
BBT40-FCM16092-85	16mm (.630)	2.165	.354	3.346	.906	2.283	2	ARG1609□□	2.6
-105		2.283		4.134	1.181	3.071			2.9
-120		2.362		4.724	.984	3.661			3.1
-150		5.906		.984	4.843	3.7			
-FCM20093-85	20mm (.787)	2.165	.354	3.346	1.102	2.283	3	ARG2009□□	2.6
-105		2.283		4.134	1.378	3.071			2.9
-120		2.362		4.724	1.181	3.661			3.1
-150		5.906		1.181	4.843	3.7			
-FCM25093-85	25mm (.984)	2.165	.354	3.346	1.299	2.283	3	ARG2509□□	2.6
-120		2.283		4.724	1.772	3.661			3.1
-135		2.362		5.315	1.575	4.252			3.5
-165		6.496		1.575	5.433	4.2			
-FCM32113-85	32mm [1.260]	2.165	.433	3.346	1.496	2.283	3	ARG3211□□	2.9
-120		2.283		4.724	2.362	3.661			3.3
-135		2.362		5.315	1.969	4.252			3.7
-165		6.496		1.575	5.433	4.6			
-FCM40114-85	40mm [1.575]	2.126	.433	3.346	1.693	2.283	4	ARG4011□□	3.1
-120		4.724		2.559	3.661	3.7			
-135		5.315		2.362	4.252	4.4			
-165		6.496		1.969	5.433	5.3			
-FCM50115-70	50mm [1.969]	2.362	.433	2.756	1.496	1.693	5	ARG4011□□	3.3
-120				4.724	2.559	3.661			4.8
-135				5.315	2.362	4.252			5.3
-165				6.496	1.969	5.433			6.6

- ap = length of effective cutting edge
- Inserts must be ordered separately

CAUTION

The integral version of the Fullcut Mill provides increased rigidity as a result of the reduced gauge length. It is particularly recommended for use in machines having a small spindle taper. Additionally, there is a cost savings as no tool holder is necessary.

ACCESSORIES



FULLCUT MILL—TYPE FCM LONG NOSE, METRIC STYLE (MAS 403)

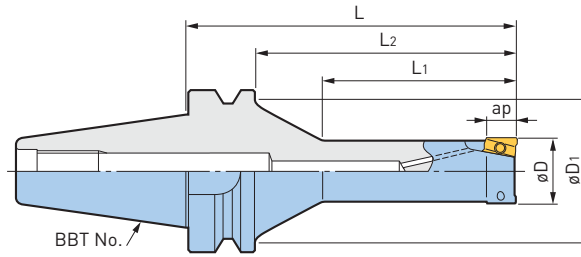

Catalog Number	øD	øD1	ap	L	L1	L2	No. of Inserts	Insert Model	Weight (lbs.)
BBT30-FCM16092L-85	16mm [.630]	1.575	.354	3.346	1.772	2.480	2	ARG1609□□	1.1
-FCM20092L-85	20mm [.787]			3.346	1.969	2.480		ARG2009□□	1.2
-FCM25092L-85	25mm [.984]			3.346	1.969	2.480		ARG2509□□	1.4
-FCM32112L-85	32mm [1.260]			3.346	2.362	2.480		ARG3211□□	1.6
BBT40-FCM16092L-105	16mm [.630]	2.362	.354	4.134	1.772	3.071	2	ARG1609□□	2.9
-120				4.724	1.772	3.661			3.1
-FCM20092L-120	20mm [.787]	2.362	.354	4.724	2.362	3.661	2	ARG2009□□	3.1
-135				5.315	2.362	4.252			3.3
-FCM25092L-135	25mm [.984]	2.362	.354	5.315	2.953	4.252	2	ARG2509□□	3.3
-150				5.906	2.953	4.843			3.7
-FCM32112L-135	32mm [1.260]	2.362	.433	5.315	3.150	3.661	2	ARG3211□□	3.7
-150				5.906	3.543	4.843			4.2

- ap = length of effective cutting edge
- Inserts must be ordered separately

ACCESSORIES



CAUTION

The integral version of the Fullcut Mill provides increased rigidity as a result of the reduced gauge length. It is particularly recommended for use in machines having a small spindle taper. Additionally, there is a cost savings as no tool holder is necessary.

FULLCUT MILL—TYPE FCM, METRIC STYLE (HSK)

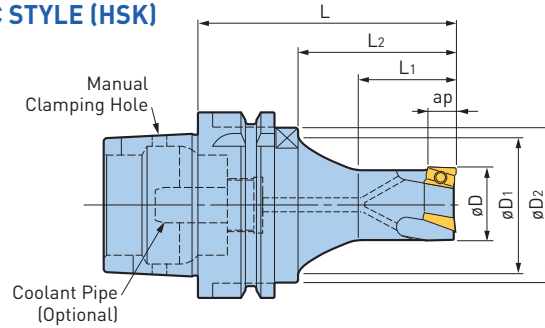

Catalog Number	ϕD	ϕD_1	ϕD_2	ap	L	L_1	L_2	No. of Inserts	Insert Model	Weight (lbs.)	
HSK-A40-FCM16092-65	16mm [.630]	.984	1.339	.354	2.560	.906	1.457	2	ARG1609□□	.7	
-FCM20093-65	20mm [.787]					1.102		3	ARG2009□□	.7	
-FCM25093-65	25mm [.984]	1.213	—	.433	—	1.378	—	4	ARG2509□□	.9	
-FCM32113-65	32mm [1.260]					1.772			ARG3211□□	1.1	
-FCM40114-65	40mm [1.575]	—	—	.433	—	—	—	5	ARG4011□□	1.3	
-FCM50115-65	50mm [1.969]								—	1.5	
HSK-A50-FCM16092-75	16mm [.630]	1.260	1.654	.354	2.953	.906	1.614	2	ARG1609□□	1.3	
-FCM20093-75	20mm [.787]					1.102		3	ARG2009□□	1.3	
-FCM25093-75	25mm [.984]	1.331	—	.433	—	1.299	—	4	ARG2509□□	1.3	
-FCM32113-75	32mm [1.260]					1.535			ARG3211□□	1.5	
-FCM40114-75	40mm [1.575]	—	—	.433	—	1.890	—	5	ARG4011□□	2.0	
-FCM50115-75	50mm [1.969]								2.2		
HSK-A63-FCM16092-85	16mm [.630]	1.811	2.087	.354	3.346	.906	2.008	2	ARG1609□□	2	
-105						4.134	1.181			2.795	2.2
-120						4.720	.984			3.386	2.4
-150						5.906	.984			4.567	2.9
-FCM20093-85	20mm [.787]	1.811	2.087	.354	3.346	1.102	2.008	3	ARG2009□□	2.2	
-105						4.134	1.378			2.795	2.4
-120						4.724	1.181			3.386	2.6
-150						5.906	1.181			4.567	3.1
-FCM25093-85	25mm [.984]	1.811	2.087	.354	3.346	1.299	2.008	3	ARG2509□□	2.2	
-120						4.724	1.772			3.386	2.6
-135						5.315	1.575			3.976	2.9
-165						6.496	1.575			5.157	3.3
-FCM32113-85	32mm [1.260]	1.811	2.087	.433	3.346	1.496	2.008	3	ARG3211□□	2.4	
-120						4.724	2.362			3.386	2.9
-135						5.315	1.969			3.976	3.1
-165						6.496	1.575			5.157	3.7
-FCM40114-85	40mm [1.575]	1.811	2.087	.433	3.346	1.693	2.008	4	ARG4011□□	2.9	
-120						4.724	2.559			3.386	3.3
-135						5.315	2.362			3.976	3.7
-165						6.496	1.969			5.157	4.6
-FCM50115-70	50mm [1.969]	—	2.087	.433	2.756	1.575	1.102	5	ARG4011□□	2.9	
-120						4.724	3.071			3.071	4.2
-135						5.315	3.661			3.661	4.8
-165						6.496	4.843			4.843	6.2

- ap = length of effective cutting edge
- Coolant Pipe & Inserts must be ordered separately

ACCESSORIES



FULLCUT MILL—TYPE FCM LONG NOSE, METRIC STYLE (HSK)

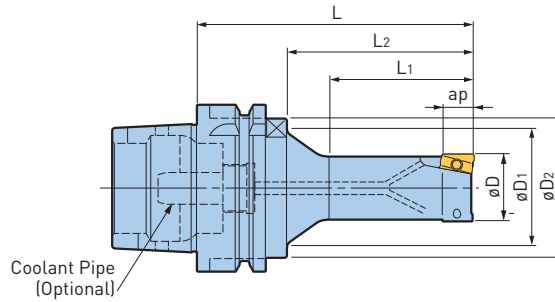

Catalog Number	øD	øD1	øD2	ap	L	L1	L2	No. of Inserts	Insert Model	Weight (lbs.)
HSK-A63-FCM16092L-85	16mm (.630)	1.772	1.969	.354	3.346	1.575	2.008	2	ARG1609□□	2.0
-120					4.724	1.772	3.386			2.2
-FCM20092L-105	20mm (.787)	1.772	1.969	.354	4.134	1.969	2.795	2	ARG2009□□	2.4
-120					4.724	2.362	3.386			2.6
-FCM25092L-105	25mm (.984)	1.772	1.969	.354	4.134	2.165	2.795	2	ARG2509□□	2.4
-120					4.724	2.559	3.386			2.6
-FCM32112L-120	32mm (1.260)	1.772	1.969	.433	4.724	2.756	3.386	2	ARG3211□□	2.9
-135					5.315	3.150	3.976			3.1

- ap = length of effective cutting edge
- Coolant Pipe & Inserts must be ordered separately

ACCESSORIES



FULLCUT MILL—TYPE FCM (HSK)

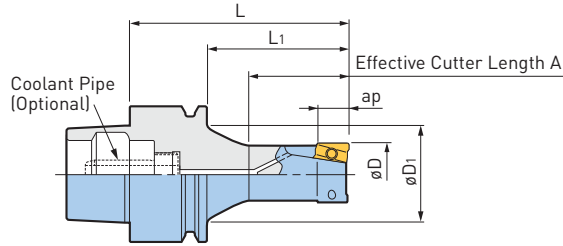

Catalog Number	øD	Effective Cutting Edge Length ap	øD1	L	L1	A	Number of Inserts	Insert Model	Weight (lbs.)
HSK-E25-FCM16092-45	16mm (.630)	.354	.748	1.77	1.38	.906	2	ARG1609□□	.4
-E32-FCM16091-55			1.02	2.17	1.38	.906			.4
-E40-FCM16091-65			1.34	2.56	1.77	1.102			1.0

• Wrench included, Coolant Pipe & Inserts must be ordered separately

ACCESSORIES



CAUTION ⚠

As the HSK-E type interface does not have drive key grooves, there is a risk that it may slip in the machine spindle and damage it if cutting load exceeds clamping force of the machine tool. Starting from the lowest possible conditions, increase them gradually while observing the cutting status, and find the optimum with sufficient safety margin.

FULLCUT MILL—TYPE FCM, INCH STYLE

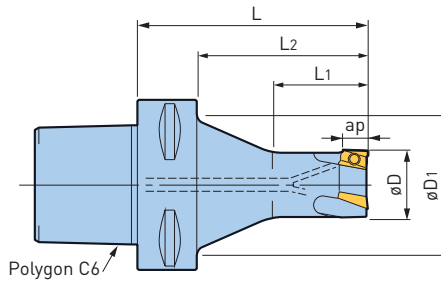

Catalog Number	øD	øD1	ap	L	L1	L2	No. of Inserts	Insert Model
C6-FCM.750-4	.750	2.285	.354	4.000	1.400	3.100	3	ARG2009□□
-FCM1.000-4	1.000			4.000	1.800	3.100	3	ARG2509□□
-FCM1.250-4	1.250			4.000	2.400	3.100	3	ARG3211□□
-FCM1.500-4	1.500	2.362	.433	4.000	2.500	3.100	4	ARG4011□□
-FCM2.000-4	2.000			4.000	2.500	3.100	5	ARG4011□□

- ap = length of effective cutting edge
- Coolant Pipe & Inserts must be ordered separately
- Metric sizes are available upon request
- C5 is available upon request (metric only)

ACCESSORIES



FULLCUT MILL—TYPE FCM STRAIGHT SHANK, INCH & METRIC STYLE

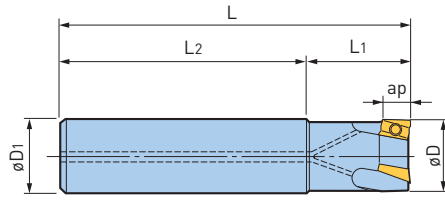

Fig. 1

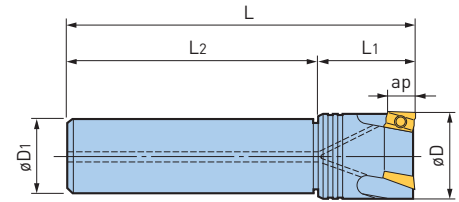

Fig. 2

Catalog Number	Fig.	øD	øD1	ap	L	L1	L2	No. of Inserts	Insert Model	Weight (lbs.)
ST.625-FCM.500-3	1	.500	.625	.354	3.000	.600	2.400	1	ARG1609□□	.2
-FCM.563-3		.563			3.000	.650	2.350			.2
-FCM.625-3		.625			3.000	1.000	2.000			2
ST.750-FCM.750-4	1	.750	.750	.354	4.000	1.250	2.750	3	ARG2009□□	.4
ST1.000-FCM1.000-5	1	1.000	1.000	.354	5.000	1.500	3.500	3	ARG2509□□	.9
ST1.250-FCM1.250-5	1	1.250	1.250	.433	5.000	1.500	3.500	3	ARG3211□□	1.5
-FCM1.500-5	2	1.500				1.500	3.500	4	ARG4011□□	1.8
-FCM2.000-5	2	2.000				1.500	3.500	5	2.1	
ST16-FCM12091-90	1	12mm [.472]	16mm [.630]	.354	3.543	.591	2.756	1	ARG1609□□	.2
-FCM14091-90		14mm [.551]			3.543	.669	2.756			.2
-FCM16092-90		16mm [.630]			3.543	.984	2.559			2
ST20-FCM20093-110	1	20mm [.787]	20mm [.787]	.354	4.331	1.181	3.150	3	ARG2009□□	.4
ST25-FCM25093-120	1	25mm [.984]	25mm [.984]	.354	4.724	1.378	3.346	3	ARG2509□□	.9
ST32-FCM32113-130	1	32mm [1.260]	32mm [1.260]	.433	5.118	1.378	3.740	3	ARG3211□□	1.5
-FCM40114-130	2	40mm [1.575]				1.575	3.543	4	ARG4011□□	1.8
-180	2	40mm [1.575]				7.087	5.512			2.6
-FCM50115-130	2	50mm [1.969]	1.575	3.543	5	2.2				

- ap = length of effective cutting edge
- Inserts must be ordered separately

ACCESSORIES



FULLCUT MILL—TYPE FCM STRAIGHT SHANK OVERSIZE, METRIC STYLE

Cutter diameter is $\varnothing 1\text{mm}$ larger than the shank diameter to avoid any interference with the workpiece.

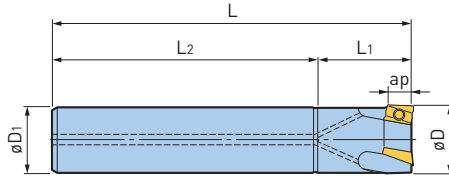

CUTTER DIAMETER

$$\varnothing D = \varnothing D1 + 1\text{mm}$$

Catalog Number	$\varnothing D$	$\varnothing D1$	a_p	L	L ₁	L ₂	No. of Inserts	Insert Model	Weight (lbs.)
ST16-FCM17092-120	17mm [.669]	16mm [.630]	.354	4.724	.984	3.740	2	ARG1609□□	.4
ST20-FCM21092-165	21mm [.827]	20mm [.787]	.354	6.496	1.181	5.315	2	ARG2009□□	.9
-FCL21093-135				5.315	1.181	4.134	3		.7
ST25-FCM26092-165	26mm [1.024]	25mm [.984]	.354	6.496	1.496	5.000	2	ARG2509□□	1.3
-FCL26093-150				5.906	1.496	4.409	3		1.3
ST32-FCM33112-180	33mm [1.299]	32mm [1.260]	.433	7.087	1.890	5.197	2	ARG3211□□	2.4
-FCL33113-180				7.087	1.890	5.197	3		2.2

- a_p = length of effective cutting edge
- Inserts must be ordered separately
- For long projection lengths and cutters with 3 inserts, please reduce the cutting parameters

ACCESSORIES



APPLICATION EXAMPLE— MATERIAL: 1055 CARBON STEEL



Fullcut Mill Model ST32-FCM33112-180	
Cutting Speed	394 SFM
Feed Rate	.004 IPT
Axial DOC	.394 x 10 steps
Radial DOC	Max. 1.299

Results

Deep shoulder end milling is achieved with 4.331 projection length and .394 axial depth.

FULLCUT MILL—TYPE FCM INSERTS



INSERT CLASSIFICATIONS

ISO Material	Grade	Material	Coating
P20	ACP200	Prehardened Steel	TiAlN/AlCrN
P30	ACP300	General Steel	
M30	ACM300S	Stainless Steel	TiAlN/TiCN
K10	ACZ310	Cast Iron	
N20	DS20	Aluminum	DLC

MARKING DESCRIPTION

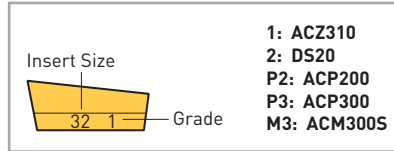

SELECTION BETWEEN ACP200 & ACP300 FOR STEEL

ACP200 is superior in anti-wear resistance, while ACP300 is superior in its anti-chipping property. ACP300 is the first recommendation for cutting steel. Choose ACP200 over ACP300 in cases where further speed or wear-resistance is needed. ACP200 is not, however, recommended for either heavily-interrupted or heavy-duty cutting.

Cutter Dia.		Insert Model	ap	Nose Radius	P		M	K	N
in	mm				ACP200	ACP300	ACM300S	ACZ310	DS20
					Prehardened Steel	General Steel	Stainless Steel	Cast Iron	Aluminum
.500-.625	12-17	ARG160902	.354	.008	—	○	○	○	○
		ARG160904		.016	○	○	○	○	○
.750	20-21	ARG200902	.354	.008	—	○	○	○	○
		ARG200904		.016	○	○	○	○	○
1.000	25-26	ARG250902	.354	.008	—	○	○	○	○
		ARG250904		.016	○	○	○	○	○
1.250	32-33	ARG321102	.433	.008	—	○	○	○	○
		ARG321104		.016	○	○	○	○	○
1.500-2.000	40-50	ARG401102	.433	.008	—	○	○	○	○
		ARG401104		.016	○	○	○	○	○

- Inserts are available in packages of 10 pcs.
- Please clarify the insert type and model when ordering (ex: ARG160902ACP200)

CAUTION

Fullcut Mill uses a different insert for each cutter diameter (except for ϕ .500-.625 & ϕ 1.500-2.000) and if an incorrect insert is used, a problem will result. There is no compatibility with those of Type FCR. Inserts with .008 nose radius are suitable for light cutting.

FULLCUT MILL—TYPE FCM SPARE PARTS

Cutter Dia.		Insert Model	Insert Clamping Screw Set (10 Screws & 1 Wrench)	Wrench
in	mm		Catalog Number	Catalog Number
.500	12	ARG1609□□	S2505DS	DA-T8
.563-.625	14-17			
.750	20-21			
1.000	25-26	ARG2509□□	S2506DS	DA-T8
1.250	32-33	ARG3211□□		
1.500	40	ARG4011□□	S3508DS	DA-T15
2.000	50			

- It is recommended to regularly replace clamping screws and wrench to ensure the correct clamping force is maintained

FULLCUT MILL—TYPE FCM CUTTING DATA

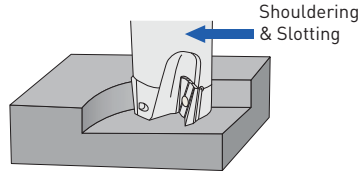

FINISH-LIGHT CUTTING

øD (mm)	Work Material	Carbon Steel Alloy Steel	Unalloyed Steel	Prehardened Steel <HRC40	Stainless Steel	Cast Iron	Aluminum
	Insert Grade	ACP300		ACP200	ACM300S	ACZ310	DS20
	Cutting Fluid	Dry			Dry	Dry	Dry/Wet
.500-.563 (12-14)	Speed (SFM)	490-820	590-820	260-455	455-590	325-655	655-2460
	Feed (IPT)	.004-.008	.004-.008	.003-.005	.005-.007	.004-.008	.004-.012
.625-.750 (16-21)	Speed (SFM)	490-820	590-820	260-455	455-590	325-655	655-3280
	Feed (IPT)	.004-.008	.004-.008	.003-.005	.005-.007	.004-.008	.004-.012
1.000-1.250 (25-33)	Speed (SFM)	590-915	655-915	260-455	455-655	325-655	655-4920
	Feed (IPT)	.004-.009	.004-.009	.003-.006	.005-.008	.004-.008	.004-.014
1.500-2.000 (40-50)	Speed (SFM)	590-915	655-915	260-455	455-655	260-655	655-4920
	Feed (IPT)	.004-.009	.004-.009	.003-.006	.005-.008	.004-.008	.004-.014

CAUTION

Fullcut Mill Type FCM cannot be used for feeding in Z-axis such as for ramping, plunging and boring.

MEDIUM-HEAVY CUTTING

øD (mm)	Work Material	Carbon Steel Alloy Steel	Unalloyed Steel	Stainless Steel	Cast Iron	Aluminum
	Insert Grade	ACP300		ACM300S	ACZ310	DS20
	Cutting Fluid	Dry		Dry	Dry	Dry/Wet
.500-.563 (12-14)	Speed (SFM)	325-655	490-655	390-590	325-590	655-2460
	Feed (IPT)	.003-.006	.003-.006	.005-.006	.003-.007	.003-.008
.625-.750 (16-21)	Speed (SFM)	325-655	490-655	390-590	325-590	655-3280
	Feed (IPT)	.003-.006	.003-.006	.005-.006	.003-.007	.003-.008
1.000-1.250 (25-33)	Speed (SFM)	325-655	525-720	390-590	325-655	655-4920
	Feed (IPT)	.003-.006	.003-.006	.005-.006	.003-.008	.003-.012
1.500-2.000 (40-50)	Speed (SFM)	325-655	525-720	390-590	325-720	655-4920
	Feed (IPT)	.003-.006	.003-.006	.005-.006	.003-.008	.003-.012

- Inserts with .008 nose radius are suitable for light cutting, however, care should be taken in the selection of both axial & radial depth of cut as well as the feed rate
- This table is a general guideline for cutting data so please adjust according to machine and workpiece conditions, as well as width of cutting

CAUTION

When a long projection model is used, it is necessary to lower the feed rate. Dry cutting (including air blow) is recommended when cutting steel, except for finishing. Dry cutting is recommended for stainless steel, however, use soluble oil in cases where severe edge build-up occurs.

CONTACT GRIP

With the unique dual contact contact grip, this threaded coupling system achieves machining capacity close to that of integrated types!

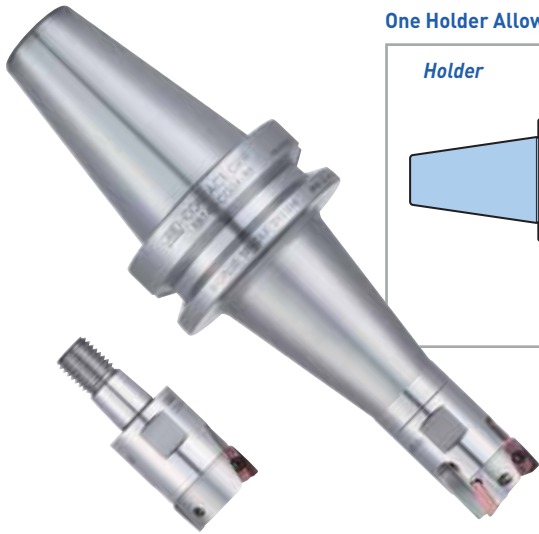

One Holder Allows Selection From Multiple Heads

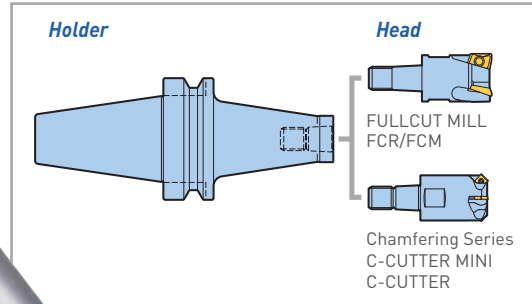

TAPER AND FLANGE FACE MAKE CLOSE CONTACT FOR SOLID CONNECTION

Thick-walled design for high rigidity

COMPLETE FIT

Force

Force

Taper concentricity improves runout accuracy

Dual contact with wide retaining surface area and fine-pitch threads enable strong retention force in any direction.



CONTACT GRIP FULLCUT MILL—TYPE FCR HEAD (PAT.)

Realizing both heavy and stable ramping.

- Shoulder Milling
- Ramping
- Helical Milling
- Peck Drilling
- Slotting

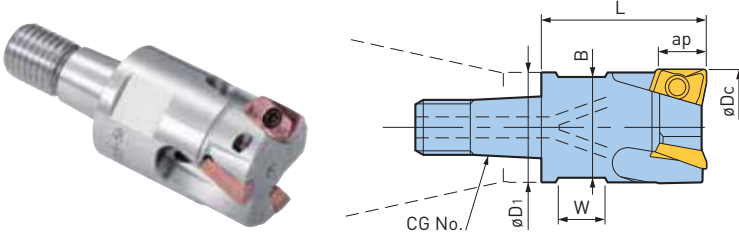

Cutter Diameter øDc	Catalog Number	CG	øD1	Effective Cutting Edge Length ap	L	Number of Inserts	Flat for Wrench		Insert Model	Weight (lbs.)
							B	W		
16mm	CG15-FCR16082-25	CG15	.590	.315	.984	2	.472	.244	BRG1608□□	.1
20mm	CG19-FCR20082-32	CG19	.748	.315	1.260	2	.669	.323	BRG2008□□	.2
	-FCR20083-32					3				
25mm	CG24-FCR25082-36	CG24	.945	.315	1.417	2	.866	.402	BRG2508□□	.3
	-FCR25083-36					3				
32mm	CG31-FCR32102-43	CG31	1.220	.394	1.693	2	1.063	.480	BRG3210□□	.6
	-FCR32103-43					3				

- Insert clamping screws and wrench are included, inserts and single-ended wrench must be ordered separately
- When used with a body of L=100mm or longer, 2-flute model is recommended for medium/ heavy slotting or ramping

ACCESSORIES



CONTACT GRIP FULLCUT MILL—TYPE FCM HEAD (PAT.)

Low resistance, high efficiency cutter especially for cross-feed machining.

- Shoulder Milling
- Slotting

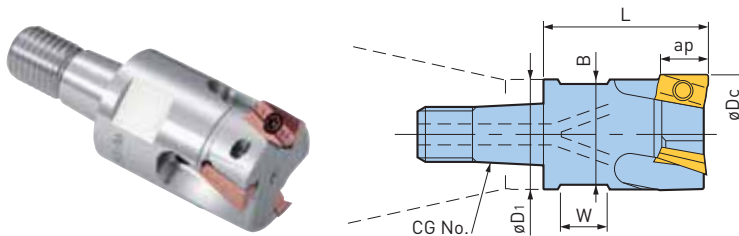

Cutter Diameter øDc	Catalog Number	CG	øD1	Effective Cutting Edge Length ap	L	Number of Inserts	Flat for Wrench		Insert Model	Weight (lbs.)
							B	W		
16mm	CG15-FCM16092-25	CG15	.590	.354	.984	2	.472	.244	ARG1609□□	.1
20mm	CG19-FCM20092-32	CG19	.748	.354	1.260	2	.669	.322	ARG2009□□	.2
	-FCM20093-32					3				
25mm	CG24-FCM25092-36	CG24	.945	.354	1.417	2	.866	.402	ARG2509□□	.3
	-FCM25093-36					3				
32mm	CG31-FCM32112-43	CG31	1.220	.433	1.693	2	1.063	.480	ARG3211□□	.6
	-FCM32113-43					3				

- Insert clamping screws and wrench are included, inserts and single-ended wrench must be ordered separately
- When used with a body of L=100mm or longer, 2-flute model is recommended for medium/ heavy slotting or ramping

ACCESSORIES



CONTACT GRIP C-CUTTER MINI

Ultra-high feed machining enables drastic reduction of machining time.

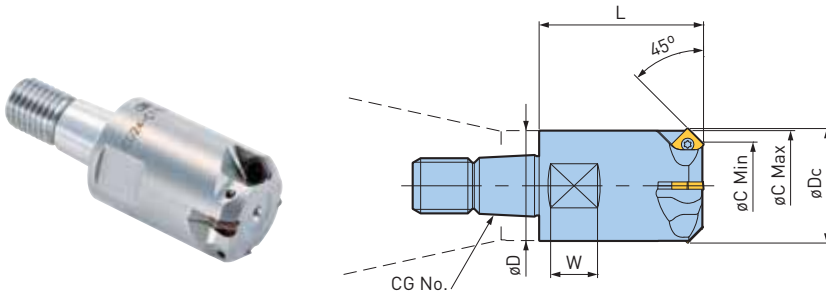

Catalog Number	CG	øD	Min. Hole øC Min	Max. Chamfer Diameter øC Max	øDc	L	Number of Inserts	Flat for Wrench		Insert Model	Weight (lbs.)
								Wrench Width	W		
CG19-C1419-45-32	CG19	.748	.557	.748	.783	1.260	4	.669	.323	CM05...	.2
CG24-C1924-45-36	CG24	.945	.748	.948	.980	1.417	4	.866	.402	CM05...	.3
CG31-C2131-45-43	CG31	1.220	.827	1.220	1.252	1.693	4	1.063	.480	CM10...	.6

• Insert clamping screws and wrench are included, inserts and single-ended wrench must be ordered separately

ACCESSORIES



CONTACT GRIP C-CUTTER—45° TYPE

Reduces the number of tools, covering a wide range of chamfering.

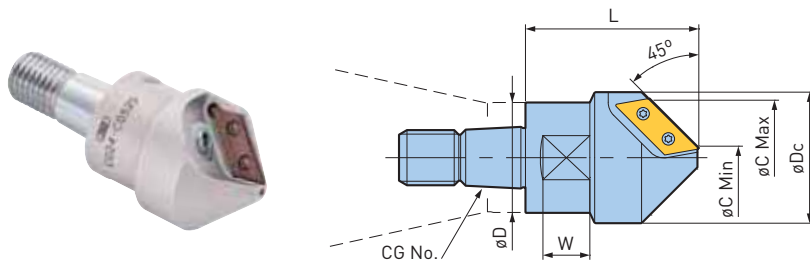

Catalog Number	CG	øD	Min. Hole øC Min	Max. Chamfer Diameter øC Max	øDc	L	Number of Inserts	Flat for Wrench		Insert Model	Weight (lbs.)
								Wrench Width	W		
CG24-C0525	CG24	.945	.197	.984	1.122	1.417	1	.866	.402	CW1206A	.3
CG31-C1040	CG31	1.220	.394	1.575	1.772	2.047	2	1.063	.480	CW1909A	.7

• Insert clamping screws and wrench are included, inserts and single-ended wrench must be ordered separately

ACCESSORIES



CONTACT GRIP C-CUTTER—UNIVERSAL TYPE

Covers chamfering angles from 5° to 85°.

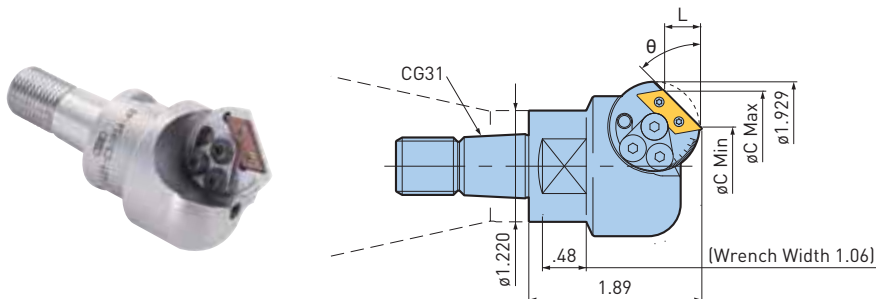

Catalog Number	CG
CG31-C5/85A-48	CG31

- Compatible insert: CW1206A

ACCESSORIES



CHAMFERING RANGE

Chamfering Angle θ	Min. Hole ϕC Min	Max. Chamfer Diameter ϕC Max	L
5°	.217	1.319	.047
10°	.287	1.366	.094
15°	.354	1.425	.142
20°	.441	1.472	.185
25°	.512	1.520	.232
30°	.598	1.559	.276
35°	.685	1.594	.315
40°	.772	1.622	.354
45°	.858	1.646	.394
50°	.945	1.661	.425
55°	1.039	1.669	.449
60°	1.122	1.673	.476
65°	1.209	1.669	.492
70°	1.295	1.657	.496
75°	1.374	1.642	.500
80°	1.452	1.618	.469
85°	1.528	1.587	.339

- Chamfering range and L are reference only
- Measure accurate values such as with a presetter

CONTACT GRIP BIG-PLUS HOLDER

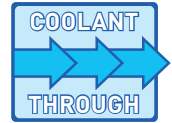
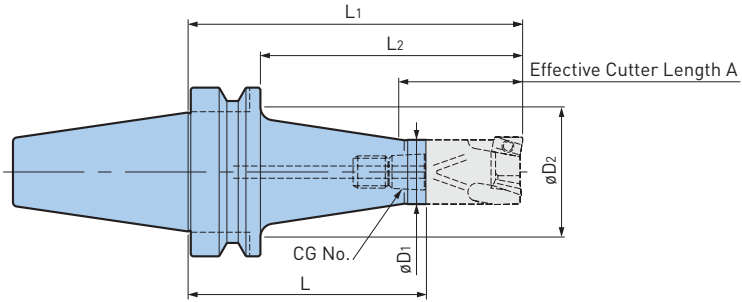

Catalog Number	CG	øD1	øD2	L	L1	L2	A	Weight (lbs.)
BBT30-CG15-50	CG15	.590	1.575	1.969	2.953	2.087	1.220	1.1
-80			1.575	3.150	4.134	3.268	1.260	1.3
-CG19-43	CG19	.748	1.575	1.693	2.953	2.087	1.535	1.0
-73			1.654	2.874	4.134	3.268	1.575	1.3
-CG24-39	CG24	.945	1.614	1.535	2.953	2.087	1.772	1.0
-69			1.654	2.717	4.134	3.268	1.772	1.4
-CG31-32	CG31	1.220	1.614	1.260	2.953	2.087	1.929	.9
-62			1.575	2.441	4.134	3.268	2.087	1.3
BBT40-CG15-50	CG15	.590	1.811	1.969	2.953	1.890	1.181	2.4
-80			1.890	3.150	4.134	3.071	1.260	2.6
-100			1.929	3.937	4.921	3.858	1.260	2.9
-CG19-43	CG19	.748	1.772	1.693	2.953	1.890	1.417	2.4
-73			1.890	2.574	4.134	3.071	1.575	2.6
-93			1.929	3.661	4.921	3.858	1.575	2.9
-CG24-39	CG24	.945	1.535	1.535	2.953	1.890	1.614	2.2
-69			1.890	2.717	4.134	3.071	1.772	2.6
-89			1.929	3.504	4.921	3.858	1.772	2.9
-CG31-37	CG31	1.220	1.693	1.457	3.150	2.087	1.890	2.2
-77			2.244	3.031	4.724	3.661	2.087	3.1
-92			2.244	3.622	5.315	4.252	2.087	3.3
BBT50-CG15-115	CG15	.590	3.543	4.528	5.512	4.016	1.181	9.7
-145			3.150	5.709	6.693	5.197	1.772	9.7
-CG19-108	CG19	.748	3.543	4.252	5.512	4.016	1.496	9.7
-153			3.150	6.024	7.283	5.787	2.362	9.9
-CG24-114	CG24	.945	3.543	4.489	5.906	4.409	1.654	9.9
-164				6.459	7.874	6.378	2.953	10.8
-CG31-107	CG31	1.220	3.740	4.213	5.906	4.409	1.969	10.3
-157			3.543	6.181	7.874	6.378	3.543	11.0

- Single-ended wrench for head tightening is not included
- L1, L2, and A above are values with a FULLCUT MILL type head mounted

ACCESSORIES



APPLICATION EXAMPLES



RAMPING

Cutting Conditions

Machine: BBT40 Vertical Machining Center
 Head Type: FCR32 [3-inserts]
 Holder: BBT40-CG31-37
 Work Material: 1040
 Cutting Speed: 500 SFM
 Feed Rate: .004"/Tooth
 Axial Depth of Cut: Max. .394" [3° ramping]
 *Example is dry cutting



SLOTING

Cutting Conditions

Machine: BBT40 Vertical Machining Center
 Head Type: FCM32 [2-inserts]
 Holder: BBT40-CG31-92
 Work Material: 1040
 Cutting Speed: 500 SFM
 Feed Rate: .004"/Tooth
 Axial Depth of Cut: .433"
 *Example is dry cutting

CONTACT GRIP HSK HOLDER—A Type (DIN9893-1) (ISO12164)

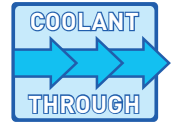
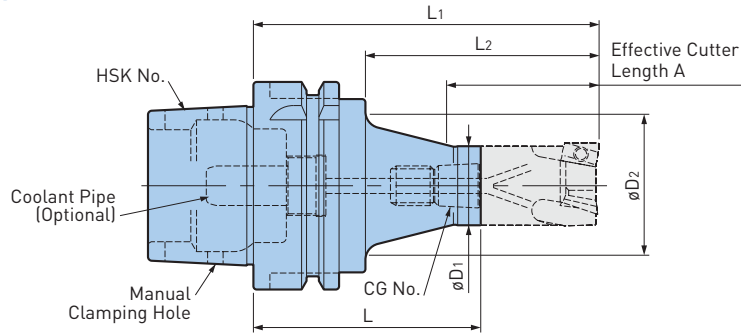

Catalog Number	CG	øD1	øD2	L	L1	L2	A	Weight (lbs.)
HSK-A63-CG15-50	CG15	.590	1.417	1.969	2.953	1.614	1.181	1.8
-80			1.772	3.150	4.134	2.795	1.220	2.2
-100			1.772	3.937	4.921	3.583	1.260	2.2
-CG19-73	CG19	.748	1.772	2.874	4.134	2.795	1.535	2.2
-93			1.772	3.661	4.921	3.583	1.575	2.2
-CG24-69	CG24	.945	1.772	2.707	4.134	2.795	1.732	2.2
-89			1.772	3.504	4.921	3.583	1.772	2.4
-CG31-77	CG31	1.220	1.772	3.031	4.724	3.386	2.087	2.2
-92			1.772	3.622	5.315	3.976	2.087	2.4

- Coolant Pipe & Single-ended wrench for head tightening is not included
- L1, L2, and A above are values with a FULLCUT MILL type head mounted

CONTACT GRIP BIG CAPTO HOLDER—C6 (ISO26623-1)

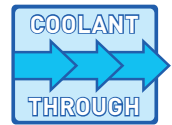
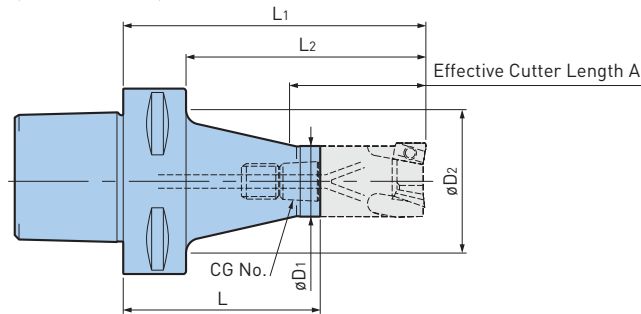

Catalog Number	CG	øD1	øD2	L	L1	L2	A	Weight (lbs.)
C6-CG15-50	CG15	.590	1.811	1.969	2.953	2.087	1.220	2.0
-80			1.890	3.150	4.134	3.268	1.220	2.2
-100			1.929	3.937	4.921	4.055	1.260	2.4
-CG19-43	CG19	.748	1.772	1.693	2.953	2.087	1.535	2.0
-73			1.890	2.574	4.134	3.268	1.535	2.2
-93			1.929	3.661	4.921	4.055	1.575	2.4
-CG24-69	CG24	.945	1.929	2.717	4.134	3.268	1.732	2.2
-89			1.929	3.054	4.921	4.055	1.772	2.4
-CG31-77	CG31	1.220	2.244	3.031	4.724	3.858	2.087	2.7
-92			2.244	3.622	5.315	4.449	2.087	2.9

- Single-ended wrench for head tightening is not included
- L1, L2, and A above are values with a FULLCUT MILL type head mounted

FULLCUT MILL—ARBOR TYPE FORM FMH

Arbor Type for Square Shoulder & Face Milling

CUTTER DIAMETER: \varnothing 50mm, \varnothing 63mm, \varnothing 80mm & \varnothing 100mm

Conforms to Form FMH of the new standard face milling adapters.

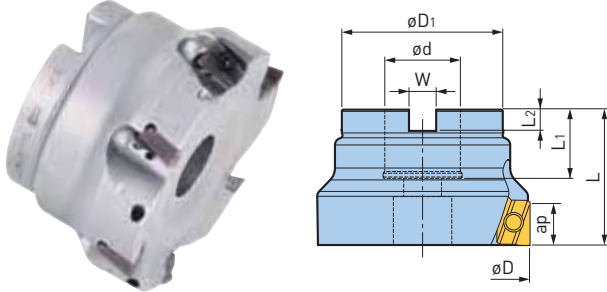

Cutter Dia. \varnothing D	Catalog Number	ap	\varnothing d	\varnothing D1	L	L1	L2	W	No. of Inserts	Insert Size	Weight (lbs.)
50mm	FMH22-FCM50115-40	.433	22mm	1.850	1.575	.787	.236	.409	5	ARG40	1.1
63mm	-FCM63116-40								6	ARG63	1.5
80mm	FMH27-FCM80116-50		27mm	2.362	1.969	.866	.276	.488	6	ARG80	2.7
100mm	-FCM100116-50								6	ARG80	4.4

- All dimensions shown in millimeters
- Wrench and screws are included, inserts must be ordered separately

FULLCUT MILL—FCM ARBOR TYPE INDEXABLE INSERTS



INSERT CLASSIFICATIONS

ISO Material	Grade	Material	Coating
P20	ACP200	Prehardened Steel	TiAlN/AlCrN
P30	ACP300	General Steel	
M30	ACM300S	Stainless Steel	TiAlN/TiCN
K10	ACZ310	Cast Iron	DLC
N20	DS20	Aluminum	

MARKING DESCRIPTION

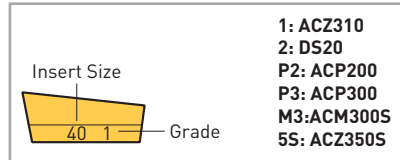

SELECTION BETWEEN ACP200 & ACP300 FOR STEEL

ACP200 is superior in anti-wear resistance, while ACP300 is superior in its anti-chipping property. ACP300 is the first recommendation for cutting steel. Choose ACP200 over ACP300 in cases where further speed or wear-resistance is needed. ACP200 is not, however, recommended for either heavily-interrupted or heavy-duty cutting.

Cutter Dia.	Insert Model	ap	Nose Radius	P		M		K	N
				ACP200	ACP300	ACM300S	ACZ350S	ACZ310	DS20
50mm	ARG401102	.433	.008	—	○	○	○	○	○
	ARG401104		.016	○	○	○	○	○	○
63mm	ARG631104		.016	—	○	○	—	—	○
	ARG631108		.031	○	○	○	○	○	○
80mm, 100mm	ARG801104	.016	—	○	○	○	—	—	○
	ARG801108	.031	○	○	○	○	○	○	○

- Inserts are available in packages of 10 pcs.
- Please clarify the insert model and grade when ordering (ex: ARG401104ACP300)

CAUTION

It is important to use the correct insert for the specific diameter of Fullcut Mill. Failure to use the correct insert will result in incorrect cutting conditions and poor results.

Perpendicularity and Beautiful Surface Finish Unmatched in Indexable Insert Cutters
 Machined by Fullcut Mill Model: FMH22-FCM63116-40
 Arbor Model: BBT40-FMH22-27-45



Squareness	
Cutting Speed (SFM)	500
Feed Rate (IPT)	.004"
Axial DOC (Ad)	.20"
Radial DOC (Rd)	.004"

	.0004"
Other Manufacturer	.0016"

Wiper Cutting Edge	
Cutting Speed (SFM)	825
Feed Rate (IPT)	.008"
Axial DOC (Ad)	.004"
Radial DOC (Rd)	2"

Ra	
	.51µm
Other Manufacturer	1.56µm

- The perpendicularity & surface roughness will vary depending on the cutting conditions, material, machine tool & workpiece rigidity.

FULLCUT MILL—FCM ARBOR TYPE CUTTING CONDITIONS

Finish-Light Cutting						
Cutter Dia.	Work Material	Carbon Steel Alloy Steel	Unalloyed Steel	Stainless Steel	Cast Iron	Aluminum
	Insert Grade	ACP300		ACZ350S	ACZ310	DS20
	Cutting Fluid	Dry		Dry	Dry	Dry/Wet
ø50/ø63/ø80/ø100	Speed (SFM)	330-725	500-800	400-600	330-650	650-5000
	Feed (IPT)	.003-.007	.003-.006	.005-.006	.004-.008	.004-.012

CAUTION

Fullcut Mill FCM Arbor Type cannot be used for feeding Z-axis such as ramping, plunging and boring.

Medium-Heavy Cutting							
Cutter Dia.	Work Material	Carbon Steel Alloy Steel	Unalloyed Steel	Prehardened Steel <HRC40	Stainless Steel	Cast Iron	Aluminum
	Insert Grade	ACP300		ACP200	ACZ350S	ACZ310	DS20
	Cutting Fluid	Dry			Dry	Dry	Dry/Wet
ø50/ø63/ø80/ø100	Speed (SFM)	330-725	500-800	250-400	400-600	330-650	650-5000
	Feed (IPT)	.004-.010	.004-.009	.003-.006	.005-.008	.004-.010	.004-.014

CAUTION

This table is a general guideline for cutting data. Please adjust according to machine and workpiece conditions, as well as width of cutting. Dry cutting (including air blow) is recommended when cutting steel, except for finishing. Dry cutting is recommended for stainless steel. However, use soluble oil in a case where severe built-up edge occurs.

FULLCUT MILL—FCM ARBOR TYPE SPARE PARTS

		Insert Clamping Screw Set (10 Screws & 1 Wrench)	Wrench
Cutter Dia. (mm)	Insert Model	Catalog Number	Catalog Number
50	ARG4011□□	S3508DS	DA-T15
63	ARG6311□□		
80, 100	ARG8011□□		

- It is recommended to regularly replace clamping screws and wrench to ensure the correct clamping force is maintained

SPEED FINISHER

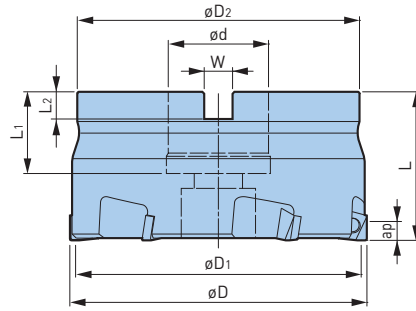

Catalog Number	ϕD	ϕD_1		ϕD_2	ϕd	L	L ₁	L ₂	W	No. of Inserts	Max RPM	Weight (lbs.)
		DA2200	CBN									
FM22-PLS505-35	50mm	1.846	1.768	1.850	22mm	1.378	.748	.236	.409	5	20,000	.9
-PLS636-35	63mm	2.358	2.280	2.362								1.5
FM27-PLS806-40	80mm	3.028	2.949	2.992	27mm	1.575	.866	.276	.488	6	16,000	2.6
-PLS1006-35●	100mm	2.752	3.736	2.362	27mm	1.378	.157	.276	.488		12,800	2.9
-PLS1256-35●	125mm	121.9	119.9	2.362							10,200	4.2
FM32-PLS1006-42	100mm	3.815	3.736	3.780	32mm	1.654	.945	.315	.567	6	12,800	4.4
FM40-PLS1258-50	125mm	4.799	4.720	3.780	40mm	1.969	1.102	.394	.646	8	10,000	7.3
-PLS16010-50	160mm	6.177	6.098	3.780								

- All dimensions shown in millimeters
- Wrench and screws are included
- Inserts must be ordered separately
- When using at 12,000 RPM or higher, contact BIG KAISER agent for balancing of the cutter and arbor assembly
- Effective cutting edge length ap varies depending on insert models—refer to the table for insert shown below
- Adjusting amount of cutting edge is .004"—note this when using reground insert
- Models marked ● are designed for BT30 holders

ACCESSORIES

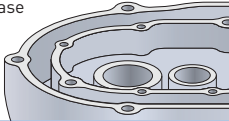
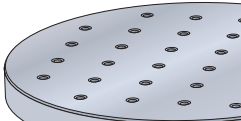
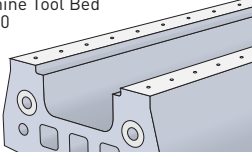

APPLICATION EXAMPLES (CUTTER DIAMETER: Ø80MM)

Workpiece	Conditions	Surface Roughness	Height Difference	No. of Workpieces	Result
 <p>Crank Case ADC12</p>	<p>Cutting Speed: 13,123 SFM Spindle Speed: 15,900 RPM Feed Rate: 376 IPM D.O.C.: .098"</p>	<p>Ra=.08µm Rz=.55µm</p>	<p>Within 1µm</p>	<p>24,000</p>	<p>Rough & Finish Processes are Combined in a Single Operation</p>
 <p>Parts of Semiconductor Manufacturing Equipment A5052</p>	<p>Cutting Speed: 13,123 SFM Spindle Speed: 15,900 RPM Feed Rate: 376 IPM D.O.C.: .079"</p>	<p>Ra=.07µm Rz=.32µm</p>	<p>Within 1µm</p>	<p>320</p>	<p>Mirror Finish is Achieved</p>
 <p>Machine Tool Bed FC250</p>	<p>Cutting Speed: 4,921 SFM Spindle Speed: 6,000 RPM Feed Rate: 142 IPM D.O.C.: .020"</p>	<p>Ra=.12µm Rz=.67µm</p>	<p>Within 2µm</p>	<p>20</p>	<p>1-2µm Flatness is Obtained</p>

SPEED FINISHER INSERTS

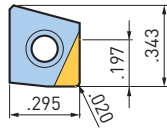
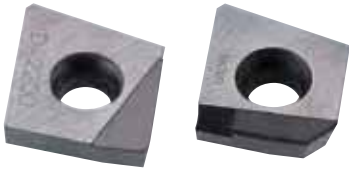

Fig. 1

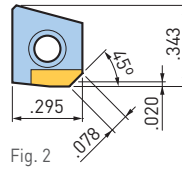

Fig. 2

Catalog Number	Workpiece	Fig.	Material	Cutting Edge Length (ap)
PL0705-DA2200	Aluminum & Nonferrous	1	Diamond	.197
PL0705-CBN	Cast Iron	2	CBN	.020

- All dimensions shown in millimeters
- Each insert is packed in a case (order example: PL0705 DA2200 5 pcs.)
- Regrinding of the insert is possible only once (grinding amount .008")
- Early regrinding is recommended, since regrinding becomes unavailable after excessive wear or once chipping occurs

INSERT CLASSIFICATIONS

DA2200	CBN
High density sintered material made of ultra-micro diamond particles. Superior wear resistance and hardness comparable to carbide alloy.	Newly designed CBN sintered body with high content rate of CBN improves toughness and thermal conductivity.

SPEED FINISHER CUTTING CONDITIONS

Workpiece Material		Insert Material	Cutting Speed (SFM)	Feed Rate (IPT)	Coolant
Aluminum Alloy	Si Content 13%≥	DA2200	6,600-13,000	.002-.008	Wet
	Si Content 13%<		1,300-2,600		
Copper Alloy		DA2200	1,600-8,200	.002-.008	Wet
Gray Cast Iron		CBN	2,600-6,600	.004-.012	Dry

- The table is a reference to determine cutting conditions and it should be adjusted according to cutting width and conditions of the machine tool and workpiece

SPEED FINISHER SPARE PARTS

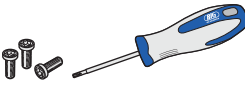
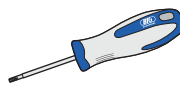
<p>Lifting Screw Set (1 Lifting Screw & 1 Lifting Nut)</p> 	<p>Insert Clamping Screw Set (10 Screws & 1 Wrench)</p> 	<p>Wrench</p> 
Catalog Number	Catalog Number	Catalog Number
LSN35	S2506DS	DA-T8

- Insert clamping screws and wrenches are consumables, therefore regular replacement and extra stock are recommended

SURFACE MILL

CUTTER DIAMETER: $\phi 80\text{mm}$

45° Approach Face Milling Cutter

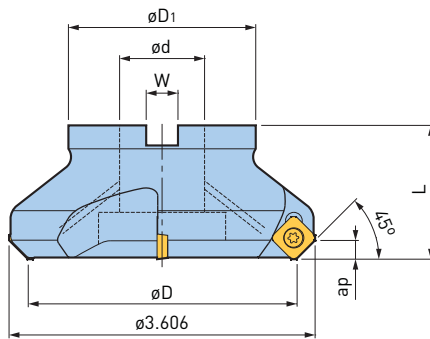

Cutter Dia. ϕD	Catalog Number	a_p	ϕd	ϕD_1	L	W	No. of Inserts	Insert Size	Weight (lbs.)
80mm	FM25.4-SFM804-40	1.970	1.000	2.205	1.575	.374	4	CM10	2.0
	FM27-SFM804-40		27mm	2.362		.488			

- Wrench and screws are included
- Inserts must be ordered separately

ACCESSORIES

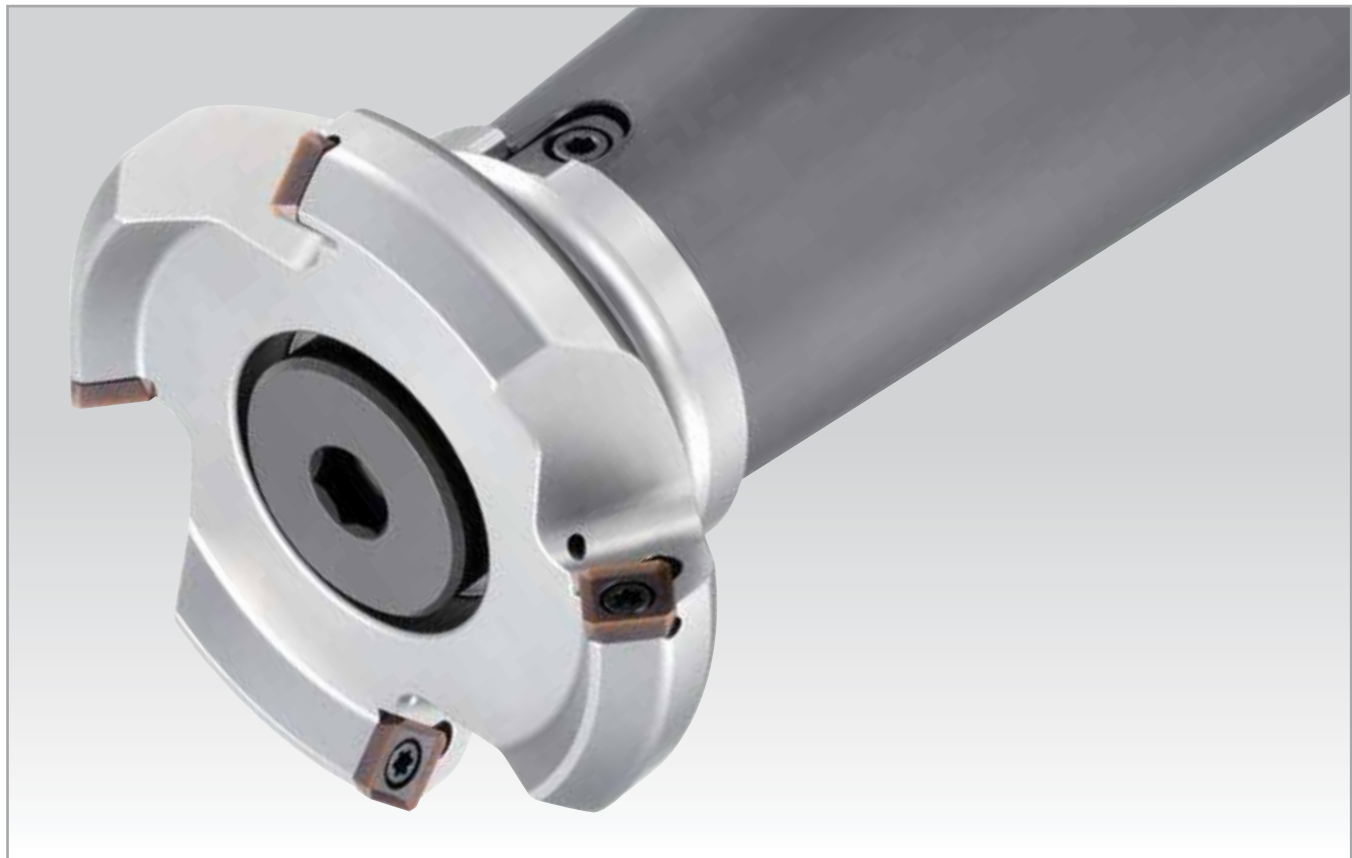

SURFACE MILL INSERTS

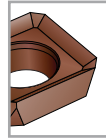
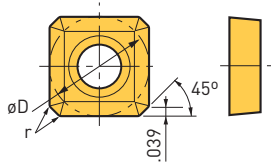
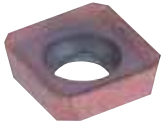

SE (SHARP EDGE) TYPE!

Sharp edge prevents burrs. Recommended for stainless steel & mild steel.

INSERT CLASSIFICATIONS

ACP200/ACP300	ACM250F	DS20
For all steel & stainless steel materials.	For stainless steel materials.	For aluminum & /non-ferrous materials.
Multi-layer PVD coating on carbide base with nanoscale TiAlN & AlCrN. Excellent performance and wear resistance.	PVD-coated carbide with excellent smoothness and resistance to welding and chipping, due to the ultra-multilayered thin film structure made of AlTiN and TiAlCrN	DLC coating on carbide base with very smooth surface for a low coefficient of friction. Excellent performance against built-up edge.

Catalog Number	øD	Nose Radius	Insert Grade			Insert Clamping Screw Set
			ACP200	ACM250F	DS20	
CM10C1	.394	.008	○	○	○	S4S-T15
CM10C1SE			○	—	—	

- Inserts are available in packages of 10 pcs.
- Please clarify the insert model and grade when ordering (ex: CM10C1ACP200)
- 10 screws and 1 wrench are included with Insert Clamping Screw Set
- It is recommended to regularly replace clamping screws and wrench to ensure the correct clamping force is maintained
- SE in the Insert Model means Sharp Edge Type

SPEED FINISHER SPARE PARTS

<p>Insert Clamping Screw Set (10 Screws & 1 Wrench)</p>	<p>Wrench</p>
Catalog Number	Catalog Number
S4S-T15DS	DA-T15

- Insert clamping screws and wrenches are consumables, therefore regular replacement and extra stock are recommended

C-CUTTER MINI—MULTI-INSERT TYPE



CUTTING EDGE DETAILS

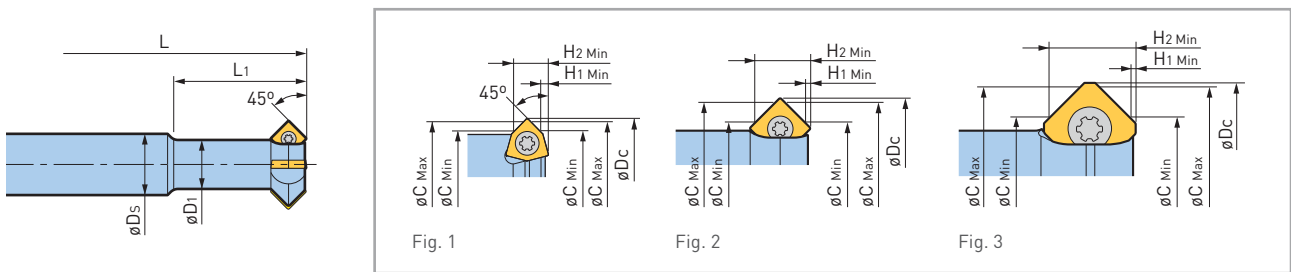

Catalog Number	Face Milling	Fig.	øDc	øDs	øD1	L	L1	øC Min	øC Max	H1 Min	H2 Min	Insert Model	No. of Inserts
ST10-C0810-45B-15	-	1	.413	.394	.291	3.071	.591	.315	.394	.028	.126	CM03...	3
-27						3.543	1.063						
ST12-C1012-45B-20	-	1	.500	.472	.354	3.661	.787	.394	.472	.039	.146	CM0402	3
-35●						4.252	1.378						
-C1116-45B-25	-	2	.673	.472	.378	3.858	.984	.433	.630	.016	.256	CM0502	4
-40●						4.449	1.575						
ST16-C1520-45B-50	-	2	.815	.630	.520	4.843	1.969	.591	.787	.024	.248	CM0502	4
ST20-C1924-45B-60	-	2	.972	.787	.677	5.630	2.362	.748	.945	.024	.248	CM0502	4
-C2232-45B-50	l	3	1.287	.787	.756	5.118	1.969	.866	1.260	.016	.488	CM10C1	
-80●						6.299	3.150						
ST32-C3242-45B-65	l	3	1.681	1.260	1.205	6.890	2.559	1.260	1.654	.016	.488	CM10C1	4
-100●						8.307	3.937						

- Wrench and screws are included, inserts must be ordered separately
- In case of chamfering, chatter may occur due to increasing cutting force when plunge cutting, so please try a different model with less inserts
- Items marked ● indicates Long Type

ACCESSORIES



C-CUTTER MINI—SINGLE INSERT TYPE

**WORLD'S
SMALLEST
INSERTS**



CUTTING EDGE DETAILS

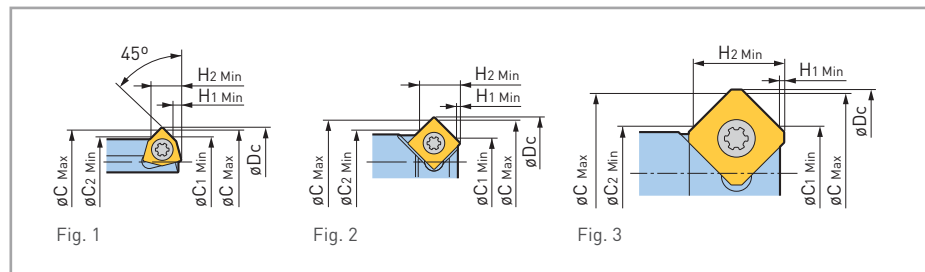
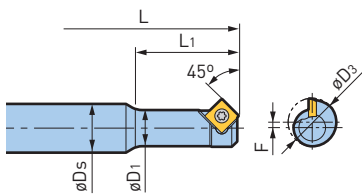

Catalog Number	Fig.	øDc	øDs	øD1	øD3	L	L1	øC1 Min	øC2 Min	øC Max	H1 Min	H2 Min	Offset F	Insert Model
ST10-C0608-45B-16	1	.346	.394	.224	.224	3.071	.630	.236	.236	.315	.039	.150	.061	CM0402
-C0409-45B-20	2	.386	.394	.213	.303	3.386	.787	.157	.236	.354	.020	.213	.043	CM0502
-C0611-45B-20	2	.472	.394	.291	.386	3.189	.787	.236	.315	.433	.016	.217	.043	
-35●						3.780	1.378							
ST16-C1222-45B-40	3	.890	.630	.433	.665	4.606	1.575	.472	.472	.866	.012	.488	.114	CM10C1

- Wrench and screws are included, inserts must be ordered separately
- Items marked ● indicates Long Type

ACCESSORIES



C-CUTTER MINI—FRONT CHAMFER TYPE



WORLD'S SMALLEST INSERTS

CUTTING EDGE DETAILS

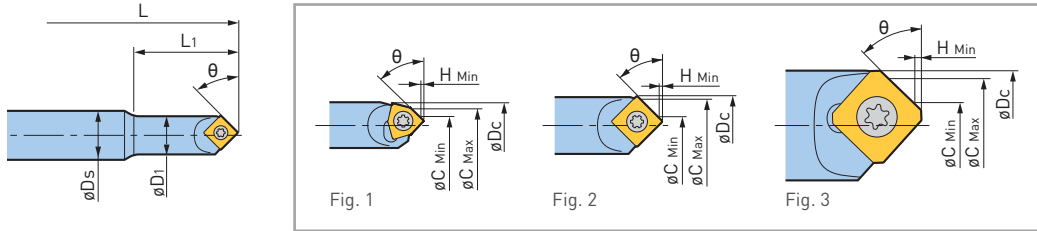

ACCESSORIES



Catalog Number	Fig.	θ	ϕDc	ϕDs	$\phi D1$	L	L1	ϕC Min	ϕC Max	H Min	Insert Model
ST8-C0103-45-16	1	45°	.193	.315	.185	2.677	.630	.039	.118	.004	CM03...
ST10-C0204-45-15	1	45°	.248	.394	.236	3.071	.591	.079	.157	.016	CM0402
-25●						3.465	.984				
-C0207-45-20	2	45°	.319	.394	.307	3.189	.787	.079	.276	.016	CM0502
-35●						3.780	1.378				
ST16-C0515-45-50	3	45°	.622	.630	.598	4.803	1.969	.197	.591	.016	CM10C1
-C0214-30-40	3	30°	.626	.630	.606	4.134	1.575	.079	.551	.008	
-C0916-60-40	3	60°	.650	.630	.614	4.134	1.575	.354	.630	.031	

- Wrench and screws are included, inserts must be ordered separately
- Centering is not possible
- Items marked ● indicates Long Type

C-CUTTER MINI—UNIVERSAL TYPE

Chamfering angle adjustment from 5° to 85° with a hex key.

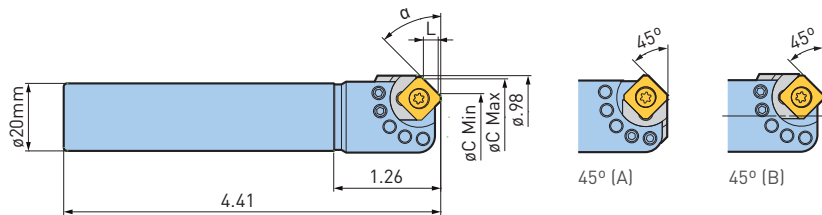

CHAMFERING RANGE

Angle α	Smallest Hole ϕC_{min}	Largest Hole ϕC_{max}	L	Angle α	Smallest Hole ϕC_{min}	Largest Hole ϕC_{max}	L
5°	.224	.740	.024	50°	.567	.913	.205
10°	.264	.776	.047	55°	.610	.917	.220
15°	.299	.807	.067	60°	.646	.917	.232
20°	.335	.835	.091	65°	.685	.913	.244
25°	.378	.858	.114	70°	.720	.906	.252
30°	.417	.878	.134	75°	.752	.894	.260
35°	.457	.894	.154	80°	.783	.878	.264
40°	.500	.906	.173	85°	.815	.862	.268
45° [A]	.539	.917	.189				
45° [B]	.528	.906	.189				

Catalog Number	Inserts
ST20-CM5/85A-30	CM10C1-ACP200
	CM10C1-DS20

ACCESSORIES



C-CUTTER MINI—BOLT AND TAPPED HOLE TYPE

WORLD'S SMALLEST INSERTS

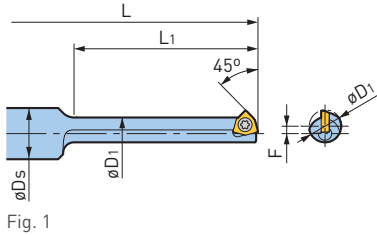

Fig. 1

CUTTING EDGE DETAILS

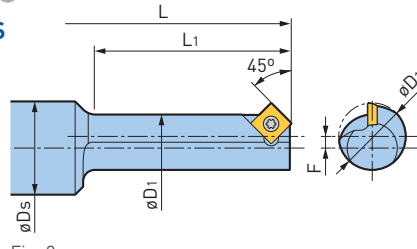
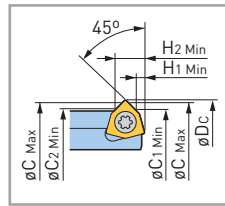
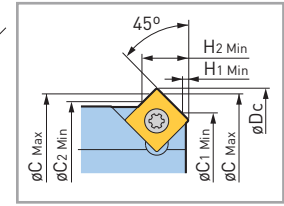

Fig. 2

CUTTING EDGE DETAILS



Catalog Number	Fig.	ϕD_c	ϕD_s	ϕD_1	L	L1	ϕC_1 Min	ϕC_2 Min	ϕC Mmax	H1 Min	H2 Min	Offset F	Insert Model
ST8-CM06-45B-14	1	.276	.315	.181	2.598	.551	.193	.193	.248	.035	.122	.047	CM03...
-26●					3.071	1.024							
ST10-CM08-45B-19	1	.362	.394	.248	3.189	.748	.252	.260	.331	.039	.146	.057	CM0402
-35●					3.819	1.378							
ST12-CM10-45B-25	2	.445	.472	.315	3.898	.984	.217	.327	.413	.020	.197	.065	CM0502
-45●					4.685	1.772							
-CM12-45B-29	2	.528	.472	.382	4.016	1.142	.299	.394	.496	.020	.205	.073	
-53●					4.961	2.087							
ST16-CM14-45B-33	2	.610	.630	.453	4.213	1.299	.382	.465	.579	.020	.209	.078	CM0502
-61●					5.315	2.402							
-CM16-45B-37	2	.693	.630	.531	4.331	1.457	.465	.543	.661	.020	.213	.081	
-69●					5.591	2.717							
ST20-CM18-45B-42	2	.776	.787	.587	4.961	1.654	.547	.598	.744	.020	.224	.094	CM0502
-78●					6.378	3.071							
-CM20-45B-46	2	.858	.787	.665	5.079	1.811	.630	.677	.827	.020	.228	.096	
-86●					6.654	3.386							

- Wrench and screws are included, inserts must be ordered separately
- For Long Type, standard inserts are recommended rather than "SE" (Sharp Edge) inserts to avoid chatter
- Items marked ● indicates Long Type

ACCESSORIES

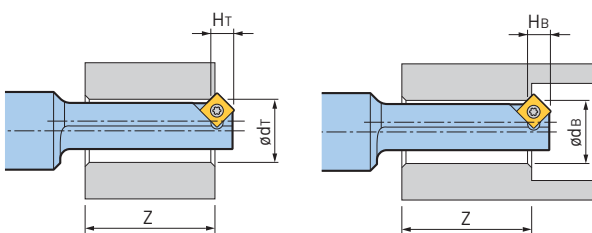

Body	Tap Hole		Bolt Hole		Z	
	ϕdT	HT	ϕdB	HB	Standard	Long
CM06	.197 (M6)	.118	.217 (M5)	.110	.394	.866
CM08	.268 (M8)	.142	.260 (M6)	.146	.512	1.142
CM10	.335 (M10)	.193	.354 (M8)	.181	.669	1.457
CM12	.406 (M12)	.197	.433 (M10)	.185	.827	1.772
CM14	.472 (M14)	.205	—	—	.984	2.087
CM16	.551 (M16)	.209	.551 (M12)	.209	1.142	2.402
CM18	.610 (M18)	.220	.630 (M14)	.209	1.299	2.717
CM20	.689 (M20)	.220	.709 (M16)	.213	1.457	3.031

C-CUTTER MINI—CKB TYPE

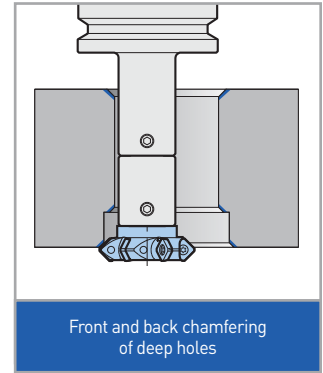
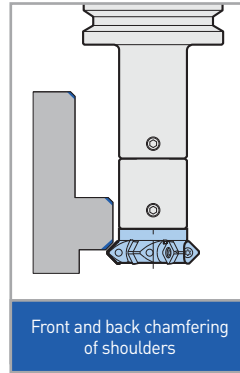
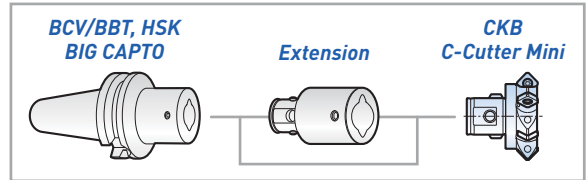
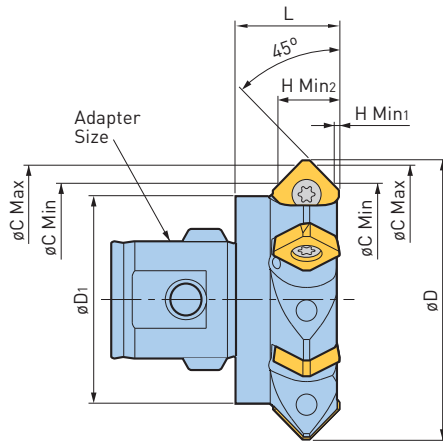

Catalog Number	Adapter Size	Face Milling	øD	øD1	L	Chamfering Dia.		H Min1	H Min2	No. of Inserts	Insert Model
						øC Min	øC Max				
CKB1-C2232-45B-20	CKB1	○	1.287	.748	.787	.866	1.260	.012	.488	4	CM10C1
CKB3-C3242-45B-20	CKB3	○	1.681	1.220	.787	1.260	1.654	.012	.488	4	CM10C1
-C5262-45B-20			2.469	1.220		2.047	2.441			6	
CKB4-C4252-45B-20	CKB4	○	2.075	1.535	.787	1.654	2.047	.012	.488	6	CM10C1
CKB5-C5262-45B-20	CKB5	○	2.469	2.008	.787	2.047	2.441	.012	.488	6	CM10C1

- Wrench and screws are included, inserts must be ordered separately
- When plunge cutting, chatter may occur due to increased cutting force, so please reduce the number of inserts to 1 or 2

ACCESSORIES



C-CUTTER MINI INSERTS

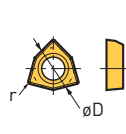

Fig. 1

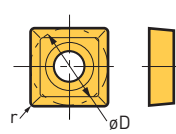

Fig. 2

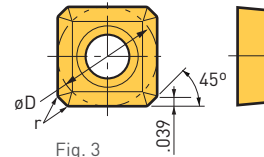
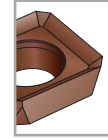

Fig. 3

INSERT CLASSIFICATIONS

ACP200/ACP300	ACM250F	DS20
For all steel & stainless steel materials.	For stainless steel materials.	For aluminum & /non-ferrous materials.
Multi-layer PVD coating on carbide base with nanoscale TiAlN & AlCrN. Excellent performance and wear resistance.	PVD-coated carbide with excellent smoothness and resistance to welding and chipping, due to the ultra-multilayered thin film structure made of AlTiN and TiAlCrN	DLC coating on carbide base with very smooth surface for a low coefficient of friction. Excellent performance against built-up edge.



SE (SHARP EDGE) TYPE!

Sharp edge prevents burrs. Recommended for stainless steel & mild steel.

Insert Model	Fig.	øD	Nose Radius	Insert Grade				Insert Clamping Screw Set
				ACP200	ACP300	ACM250F	DS20	
CM0302	1	.130	.008	—	○	—	—	S1.63-T3
CM0402	1	.156	.008	—	○	—	—	S2SS-T6
CM0502	2	.197	.008	○	—	○	○	S2TS-T6
CM0502SE				○	○	—	—	
CM10C1	3	.394	.008	○	—	○	○	S4S-T15
CM10C1SE				○	—	—	—	

- Inserts are available in packages of 10 pcs.
- Please clarify the insert model and grade when ordering (ex: CM0402ACP200)
- 10 screws and 1 wrench are included with Insert Clamping Screw Set
- It is recommended to regularly replace clamping screws and wrench to ensure the correct clamping force is maintained
- **SE** in the Insert Model means Sharp Edge Type

C-CUTTER MINI CUTTING DATA

STANDARD MODELS

Material	Insert Grade	Cutting Speed (SFM)	Feed (IPT)		Coolant
			Chamfering	Face Milling	
Carbon Steel	ACP200, ACP300	330-1155	.002-.016	.002-.008	Dry
Pre-hardened Steel <HRC40		198-330	.002-.004	.002-.004	Wet
Stainless Steel	ACM250F	330-825	.003-.012	.003-.008	Dry/Wet
Cast Iron	ACP200, ACP300	330-1155	.004-.020	.002-.010	Dry
Aluminum/Unalloyed Steel	DS20, ACP300	330-2640	.004-.020	.002-.012	Dry/Wet

- The table is just a reference to determine cutting conditions and it should be adjusted according to the condition of the machine tool and workpiece
- Wet cutting is recommended to obtain a good surface finish
- In case built-up edge occurs cutting aluminum and stainless steel, use soluble oil

BOLT HOLE & TAP HOLE LONG TYPE

Material	Insert Grade	Cutting Speed (SFM)	Feed (IPT)	Coolant
Carbon Steel	ACP200 ACP300	66-330	.001-.005	Wet
Cast Iron		165-528	.002-.008	Dry
Aluminum/Unalloyed Steel		99-330	.001-.005	Wet

- The table is just a reference to determine cutting conditions and it should be adjusted according to the condition of the machine tool and workpiece
- For stainless and pre-hardened steels, Standard Model, not Long Type, is recommended

C-CUTTER

Covers a Wide Range of Chamfering Diameters and Reduces the Number of Tools and ATC Required!

Designed exclusively for chamfering, the insert has a large rake angle and produces a clean chamfering surface. A wide machining range reduces the number of tools in the magazine and is especially effective for reducing ATC time loss.

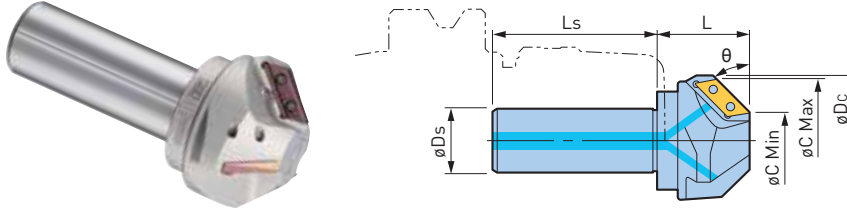
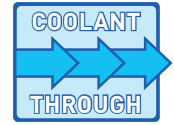

Chamfering Angle θ	Catalog Number	ϕD_s	Min. Hole ϕC_{Min}	Max. Chamfer Diameter ϕC_{Max}	Outer Diameter ϕD_C	L	Ls	Number of Inserts	Applicable Insert
30°	ST32-C1652C-30	32mm	.63	2.05	2.677	1.890	3.15	2	CW1909A
	ST42-C5085C-30	42mm	1.97	3.35	3.780	2.047		3	
45°	ST20-C0525C	20mm	.20	.98	1.299	.985	2.36	1	CW1206A
	ST25-C1040C	25mm	.39	1.57	1.772	1.378	2.76	2	CW1909A
	ST32-C3060C	32mm	1.18	2.36	2.559	1.772	3.15	3	
	ST42-C50100C	42mm	1.97	3.94	4.173	2.756		3	CW3115A
60°	ST25-C1434C-60	25mm	.55	1.34	1.535	1.457	2.76	2	CW1909A
	ST32-C3050C-60	32mm	1.18	1.97	2.126	1.772	3.15	3	
	ST32-C4565C-60		1.77	2.56	2.717	1.969		3	

• Insert clamping screws and wrench are included, Inserts must be ordered separately

ACCESSORIES



C-CUTTER—UNIVERSAL TYPE

Handles chamfering angles from 5° to 85°.

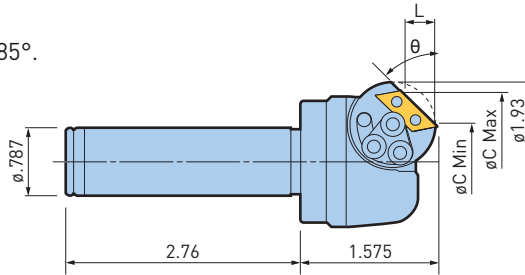

CHAMFERING RANGE

Catalog Number	Insert
ST20-C5/85A-40	CW1206A

Angle α	Smallest Hole ϕC_{min}	Largest Hole ϕC_{max}	L
5°	.217	1.319	.047
10°	.287	1.366	.094
15°	.354	1.425	.142
20°	.441	1.472	.185
25°	.512	1.520	.232
30°	.598	1.559	.276
35°	.685	1.594	.315
40°	.772	1.622	.354
45°	.858	1.646	.394

Angle α	Smallest Hole ϕC_{min}	Largest Hole ϕC_{max}	L
50°	.945	1.661	.433
55°	1.04	1.669	.433
60°	1.12	1.673	.472
65°	1.21	1.669	.512
70°	1.30	1.657	.512
75°	1.37	1.642	.512
80°	1.45	1.618	.472
85°	1.53	1.586	.339

ACCESSORIES



• Chamfering range and L are reference only, measure accurate values with a presetter

C-CUTTER—CKB TYPE

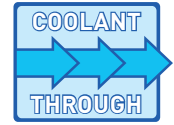
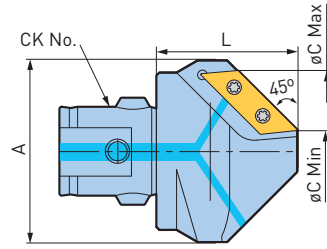

Catalog Number	Type	CK	øC Min	øC Max	L	A	No. of Inserts	Weight (lbs.)
CKB2-C0525C	C0525	CKB2	.197	.984	.984	1.122	1	.2
CKB4-C1040C	C1040	CKB4	.394	1.575	1.378	1.772	2	.6
CKB5-C3060C	C3060	CKB5	1.181	2.362	1.575	2.559	3	1.6
CKB6-C50100C	C50100	CKB6	1.969	3.937	2.559	4.173	3	6.0

- Insert clamping screws and wrench are included, Inserts must be ordered separately

C-CUTTER INSERTS

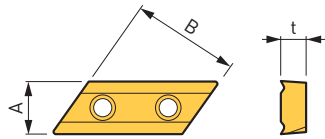

Non-Coating	Adopts P30-equivalent carbide material with emphasis on toughness for versatile use with materials from steel to aluminum.
ZX Coating	TiN and AlN multilayer coating increases speeds and extends insert life in chamfering of steel or cast iron.
DLC Coating	The exclusive substrate is treated with a thin DLC coating to prevent welding during aluminum machining. It retains sharpness and achieves a clean surface finish.

Catalog Number			A	B	t
Non-Coating	ZX Coating	DLC Coating			
CW1206A	CW1206A(ZX)	CW1206A(DLC)	.250	.500	.106
CW1909A	CW1909A(ZX)	CW1909A(DLC)	.375	.750	.177
CW3115A	CW3115A(ZX)	CW3115A(DLC)	.625	1.250	.276

- Insert is available from 1 pc.
- Insert set is available in packs of 10 pcs., please add S before each model number when ordering (Ex. SCW1206A(ZX))
- DLC coating types do not come in 10-piece sets

C-CUTTER INSERT CLAMPING SCREW SET

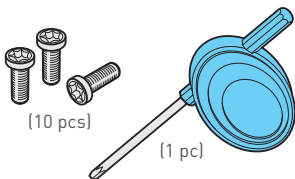

Insert	Set Model	Wrench
CW1206A	S25-B	FLR-13S
CW1909A	S35	FLR-20S
CW3115A	S55	FLR-28S

- The set contains 10 screws and 1 wrench
- Wrenches are also available separately

C-CUTTER CUTTING DATA

Vc: Cutting speed (SFM), f = Feed per revolution (in/rev)

Catalog Number	Max Chamfering Amount	Chamfering Mode	General Steels		Stainless Steel		Cast Iron		Aluminum	
			Vc	f	Vc	f	Vc	f	Vc	f
ST20-C5/85A-40	.08❖	Plunge	165	.004	100	.003	130	.004	265	.004
		Side	265	.006	200	.004	165	.006	330	.008
ST20-C0525C	.08	Plunge	165	.004	100	.003	130	.004	265	.004
		Side	265	.006	200	.004	165	.006	330	.006
ST25-C1040C	.12	Plunge	300	.006	130	.005	200	.006	330	.008
ST25-C1434C-60 ST32-C1652C-30	.12❖	Side	400	.012	200	.008	300	.012	500	.012
ST32-C3060C	.16	Plunge	400	.012	200	.007	300	.010	500	.012
ST32-C3050C-60 ST32-C4565C-60 ST42-C5085C-30	.16❖	Side	500	.018	200	.012	400	.024	650	.022
ST42-C50100C	.16	Plunge	500	.016	265	.010	400	.014	600	.016
		Side	500	.018	200	.014	400	.024	800	.022

- Cutting conditions are the same for coated and non-coated inserts.
- The use of coated inserts enables better surface finish and extended insert life
- Lower the cutting speed if the maximum chamfering amount is exceeded
- If plunge cutting produces long chips, use step feed
- We recommend the use of a high-rigidity holder for chucking (HMC, MEGA-D etc.)
- Max. chamfering amount for the 30°, 60° and Universal Types marked with ❖ is the chamfering length of the longer side

C-CUTTER APPLICATION EXAMPLE

C3 Traverse Chamfering

A clean surface with no chatter was achieved even in traverse chamfering, under high cutting conditions.

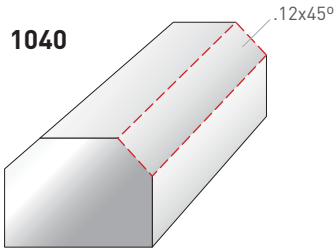

C-Cutter Model	ST25-C1040C
Insert Model	CW1909A
Spindle Speed n	3,000 RPM
Feed Vf	70"/min



C-CUTTER MICRO

Ultra-Fine Diameter Allows Both Front and Back Chamfering Even on Workpieces with Complex Shapes!

CUTTER DIAMETER: ϕ .114"-.311"

The long-neck size is convenient for deep workpiece edges, or back chamfering of drilled holes. Uses a chromium nitride coating for high resistance to build up edge.

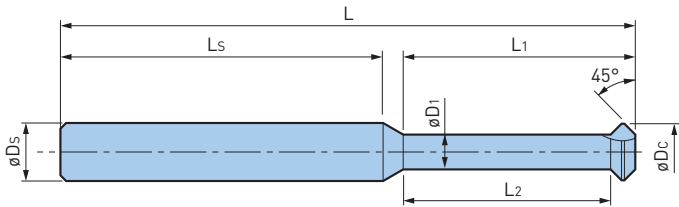

CUTTING EDGE DETAILS

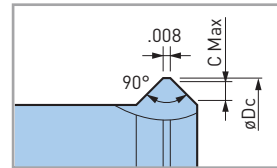

Catalog Number	ϕ Dc	ϕ D1	ϕ Ds	L	Ls	L1	L2	C Max
ST3W-CS3-45B-06	.114	.067	3mm	1.575	1.30	.236	.177	.020
-12		.075			.472	.413	.016	
ST4W-CS4-45B-08	.154	.083	4mm	1.772	1.40	.315	.236	.031
-16		.094			.630	.551	.026	
ST5W-CS5-45B-10	.193	.098	5mm	1.969	1.48	.394	.276	.043
-20		.110			.787	.689	.037	
ST6W-CS6-45B-12	.232	.118	6mm	1.969	1.40	.472	.335	.053
-24		.134		2.362	.945	.827	.045	
ST8W-CS8-45B-16	.311	.157	8mm	2.362	1.59	.630	.453	.073
-32		.177		2.756	1.38	1.260	1.102	.063

- Cutting edge material is CrN coated carbide
- Number of inserts is 3 for all models.

C-CUTTER MICRO CUTTING DATA

Workpiece Material	Cutting Speed Vc (SFM)	Feed per Tooth fz (IN/flute)
Unalloyed Steel, Carbon Steel, Alloy Steel	230-330	.002-.004
Stainless Steel	200-265	.001-.003
Cast Iron/Ductile Cast Iron	130-265	.002-.004
Aluminum/Non-ferrous	265-500	.002-.005

This table is a guideline for selecting cutting parameters. Adjust them as needed according to the machine and workpiece conditions. Generally, wet cutting provides a better surface finish. Back chamfering may require lower cutting conditions than front. Lower the feed if secondary burrs appear.

CAUTION

Keep the tool projection length as short as possible. Stop using the tool if it receives strong impact such as collision. The tool becomes hot during cutting. There is a risk of burn if touched immediately after use. Use protective equipment such as safety enclosures and glasses against scattering chips or tool breakage caused by accidents.

C-CENTERING CUTTER

A multifunction cutter capable of both spot drilling and chamfering.

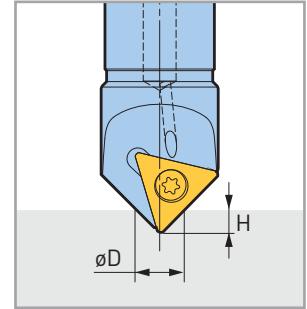
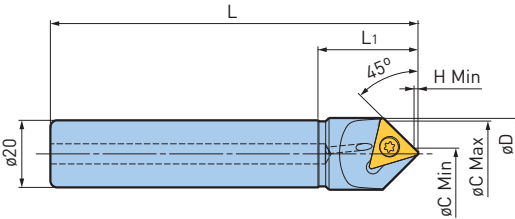
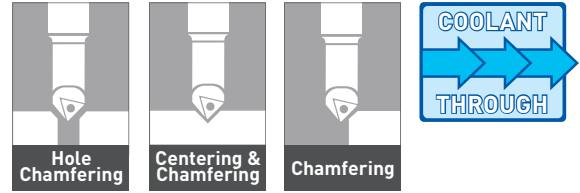

$$H = D/2 - 0.7 \text{ mm}$$

Catalog Number	Reference Number	øD	L	L1	øC Min	øC Max	H Min	Insert
ST20-CN0220-45-110	806.622	.866	4.330	1.181	.079	.787	.012	CN0906

- A wrench and a screw are included. Inserts are to be ordered separately
- As the insert has a nose radius, spot drilled tip is not acute
- Use with hand feed is not recommended

C-CENTERING CUTTER—3 INSERT

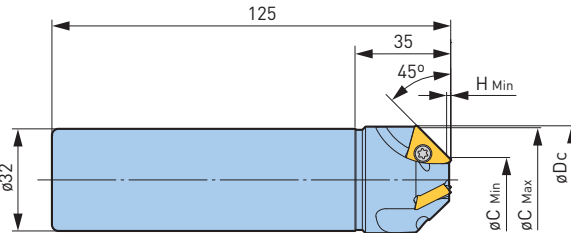

Catalog Number	øD	øC Min	øC Max	H Min	Insert
ST32-CN1433-45-125	1.339	.551	1.299	.024	CN0906

- Wrench and screw are included; inserts tip is must be ordered separately
- Centering is not possible

INSERTS FOR C-CENTERING CUTTER



Catalog Number	øD	Insert Grade		Screw Set Catalog Number
		ACM250F (For Steel/Cast Iron/Stainless Steel)	DS20 (For Aluminum)	
CN0906	.375	○	○	S4S-15IP

- Inserts are available in a packet of 10 pcs.; please specify the insert model number and grade when ordering
Example: CN0906 ACM250F.....10 Pcs
- The insert clamping screw set contains 10 screws and 1 wrench
- Insert clamping screws and tightening wrench are consumables; order periodically for replacement or spares.

RECOMMENDED CUTTING CONDITION

Workpiece Material	Cutting Speed Vc (SFM)	Feed (IPT)	
		Spot Drilling	Traverse Chamfering
Carbon Steel, Alloy Steel	165-500	.001-.003	.002-.008
Stainless Steel	165-400	.001-.002	
Cast Iron	230-650	.001-.003	
Aluminium, Non-ferrous Metals	330-1000		

- The table is just a reference to determine cutting conditions, it should be adjusted according to the condition of the machine tool and workpiece
- Be sure to use water-soluble cutting fluid during spot drilling
- For traverse chamfering, dry cutting (including air blowing) is recommended; however, if severe built-up edge occurs in aluminum machining, use water-soluble cutting fluid

CENTER BOY

Accurate Positioning of Drill Holes and Chamfering Can be Performed Simultaneously

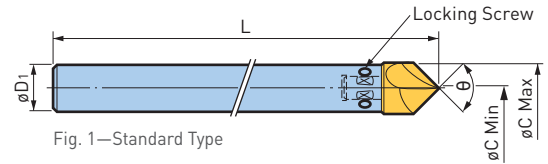

Fig. 1—Standard Type

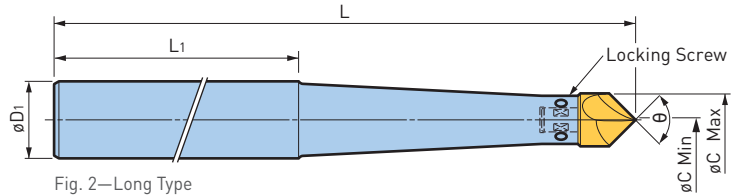

Fig. 2—Long Type

Point Angle	Fig.	Catalog Number	Chamfer Dia.		ϕD_1	L	L ₁	Insert Model	Spare Locking Screw
			ϕC_{min}	ϕC_{max}					
90°	1	ST10-CBY09010	.035	.394	.394	5.906	—	CBY09010	H0403-5P
	1	ST12-CBY09013	.035	.512	.472	5.906		CBY09013	H0504-5P
	1	ST16-CBY09016	.039	.630	.630	7.087		CBY09016	H0504-5P
	1	ST20-CBY09022	.059	.866	.787	7.087		CBY09022	H0505-5P
	2	ST20-CBY09013-220	.035	.512	.787	8.661	4.724	CBY09013	H0403-5P
		-260				10.236			
2	ST32-CBY09022-260	.059	.866	1.260	10.236	4.724	CBY09022	H0505-5P	
	-300				11.811				
120°	1	ST12-CBY12013	.035	.512	.472	5.906	—	CBY12013	H0403-5P

• Wrench and screws are included, inserts must be ordered separately

CAUTION Hand feeding is not recommended.

CENTER BOY THROWAWAY BIT

Precision-Finished Cutting Edge with Superb Sharpness

Since the bit can be replaced, there is no need for regrinding and the performance remains stable at all times.



Point Angle	Catalog Number	Body Model
90°	CBY09010	ST10-CBY09010
	CBY09013	ST12-CBY09013/ST20-CBY09013
	CBY09016	ST16-CBY09016
	CBY09022	ST20-CBY09022/ST32-CBY09022
120°	CBY12013	ST12-CBY12013

• Bits are sold as 5-piece sets.
• High-speed steel/TiN coating [Bit material]

Catalog Number	Chamfering						Centering					
	Steel		Cast Iron		Aluminum		Steel		Cast Iron		Aluminum	
	Vc	f	Vc	f	Vc	f	Vc	f	Vc	f	Vc	f
CBY09010...	65	.004	65	.005	150	.006	80	.003	100	.004	165	.006
CBY09013...	80		80		165		100		115		180	
CBY12013...	100		115		180		150		130		200	
CBY09016...	115		130		200		165		150		215	
CBY09022...												

• Vc: Cutting speed [SFM] f: Feed (in/rev)
• The values in this table are only for reference and should be adjusted based on workpiece hardness, rigidity, and chamfering amount
• Lower the cutting speed Vc if chatter occurs
• Keep the projection length as short as possible

C-CUTTER BOY

Ideal for Chamfering with a Bench Drill

- Carbide insert achieves excellent chamfering
- Carbide guide prevents chatter, enabling easy operation
- $\phi 12$ shank diameter—no chatter with a bench drill

CARBIDE GUIDE
**PREVENTS
CHATTER**

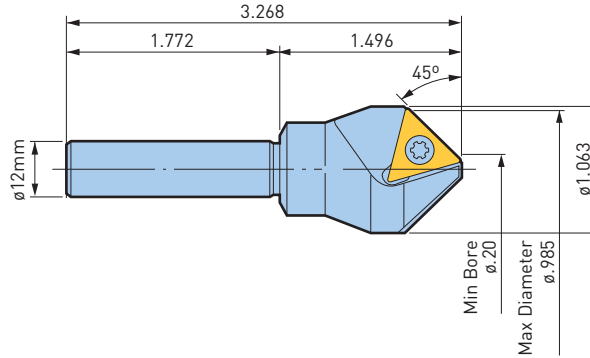
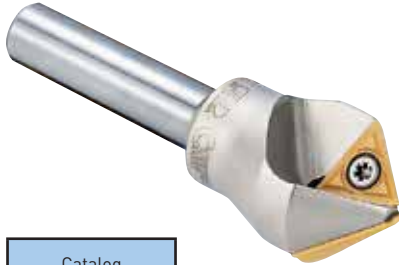

Catalog Number
ST12B-C0525

- One insert is included

C-CUTTER BOY INSERT

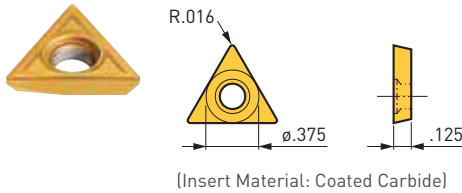

Catalog Number
C1603B

- Inserts sold in packs of 10 pcs.

INSERT CLAMPING SCREW SET



Catalog Number	Thread size	Wrench
S45	M4 x 8	FLR-20S

- The set contains 10 screws and 1 wrench
- Wrench is also available separately

CARBIDE GUIDE SET

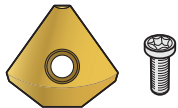

Catalog Number	Carbide Guide	Thread Size
CG0525S	CG0525	M4 x 7

- The set contains 1 carbide guide and 1 screw
- The screw compatible wrench is FLR-20S

Hole Diameter	Spindle Speed (RPM)		
	Steel	Cast Iron	Aluminum
$\phi .20$	600	800	1,000
$\phi .40$	500	600	800
$\phi .60$	400	500	600
$\phi .75$	300	400	500

- The values in this table are only for reference and should be adjusted based on workpiece hardness, rigidity and chamfering amount
- Keep runout as low as possible while machining
- We recommend the use of cutting fluid



R-CUTTER

Ultra High Feed Radius Chamfer Mill

Automated R-Chamfering available with front & back chamfering. Four insert design multiplies the feed rate.

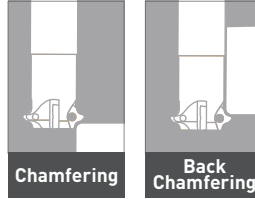

R-CUTTER—FRONT CHAMFER TYPE

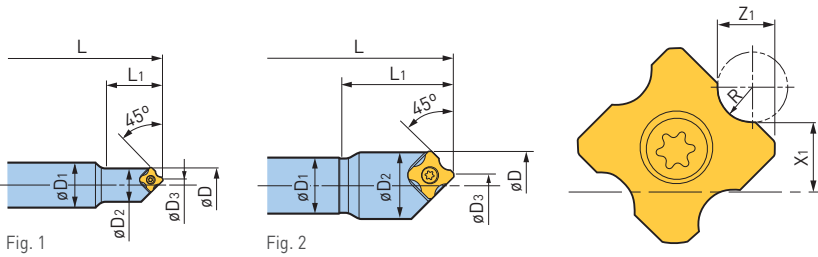

Catalog Number	Fig.	øD	øD1	øD2	øD3	L	L1	No. of Inserts	R	X1	Z1	Insert Model
ST16-RC061-20	1	.484	.630	.469	.177	3.701	.787	1	.02	.142	.076	RC06....
									.04	.132	.086	
									.06	.122	.096	
									.08	.111	.106	
ST20-RC121-40	2	.961	.787	.937	.350	4.764	1.575	1	.04	.282	.149	RC12....
									.08	.262	.169	
									.12	.241	.189	
									.16	.220	.208	

• Wrench and screws are included, inserts must be ordered separately

ACCESSORIES



R-CUTTER—FRONT & BACK CHAMFER TYPE

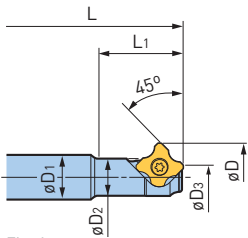

Fig. 1

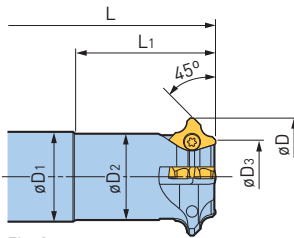
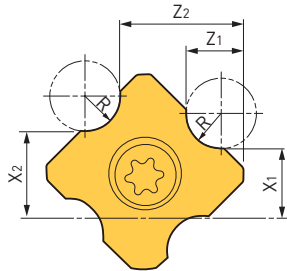

Fig. 2



Catalog Number	Fig.	øD	øD1	øD2	øD3	L	L1	R	X1	Z1	X2	Z2	No. of Inserts	Insert Model
ST10-RC061B-15	1	.484	.394	.260	.173	3.071	.591	.02	.142	.076	.169	.228	1	RC06....
								.04	.132	.086	.159	.218		
								.06	.122	.096	.149	.208		
								.08	.111	.106	.139	.198		
ST16-RC121B-30	1	.961	.630	.524	.339	4.055	1.181	.04	.282	.149	.337	.442	1	RC12....
								.08	.262	.169	.316	.422		
								.12	.241	.189	.296	.402		
								.16	.220	.208	.275	.383		
ST16-RC064B-30	2	.827	.630	.598	.520	3.976	1.181	.02	.311	.076	.338	.228	4	RC06....
								.04	.301	.086	.328	.218		
								.06	.291	.096	.319	.208		
								.08	.281	.106	.309	.198		
ST32-RC124B-50	2	1.654	1.260	1.213	1.035	5.551	1.969	.04	.624	.149	.680	.458	4	RC12....
								.08	.604	.169	.659	.438		
								.12	.584	.189	.639	.419		
								.16	.563	.208	.619	.399		

• Wrench and screws are included, inserts must be ordered separately

ACCESSORIES



R-CUTTER—CKB TYPE

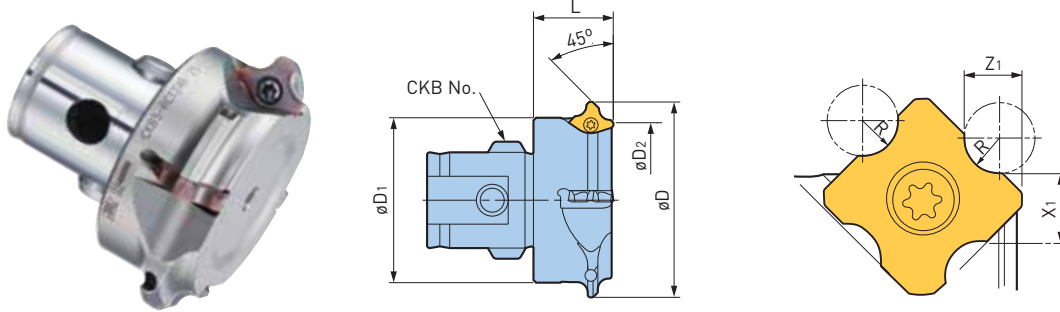

Catalog Number	CK	øD	øD1	øD2	L	No. of Inserts	R	X1	Z1	Insert Model
CKB3-RC064B-15	CKB3	1.457	1.220	1.150	.591	4	.02	.624	.076	RC06....
							.04	.615	.086	
							.06	.605	.096	
							.08	.595	.106	
CKB5-RC124B-25	CKB5	2.441	1.969	1.823	.984	4	.04	1.016	.149	RC12....
							.08	.996	.169	
							.12	.976	.189	
							.16	.957	.208	

• Wrench and screws are included, inserts must be ordered separately

ACCESSORIES



R-CUTTER INSERTS



Type	Catalog Number	Radius R	Insert Clamping Screw Set
RC06	RC06050-ACP300	.02	S2TS-T6
	RC06100-ACP300	.04	
	RC06150-ACP300	.06	
	RC06200-ACP300	.08	
RC12	RC12100-ACP300	.04	S4S-T15
	RC12200-ACP300	.08	
	RC12300-ACP300	.12	
	RC12400-ACP300	.16	

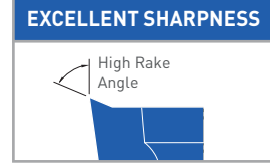

Unique Insert Geometry
High rake angle reduces cutting resistance and minimizes the generation of burrs.

- Wrench and screws are included
- Inserts are available in packages of 10 pcs.
- Material is coated carbide
- It is recommended to regularly replace clamping screws and wrench to ensure the correct clamping force is maintained

RECOMMENDED CUTTING CONDITIONS

Workpiece Material	Cutting Speed (SFM)	Feed Rate (IPT)	Coolant
Structural, Carbon or Alloy Steel	330-1150	.002-.008	Dry
Prehardened Steel <HRC40	195-260	.002-.004	Wet
Stainless Steel	330-820	.003-.008	Dry/Wet
Cast Iron	330-1150	.002-.010	Dry
Aluminum	330-2625	.002-.010	Dry/Wet

- The table is just a reference to determine cutting conditions and it should be adjusted according to the condition of the machine tool and workpiece
- Wet cutting is recommended to obtain a good surface finish
- In case built-up edge occurs cutting aluminum and stainless steel, use soluble oil

BF-CUTTER

Exclusively Designed for Back Spot Facing of Cap Bolt Holes

HOLE DIAMETER: \varnothing .256"-1.300" (\varnothing 6.5-33mm)

Cap bolt size M6-M16, for \varnothing 1/4"-5/8"

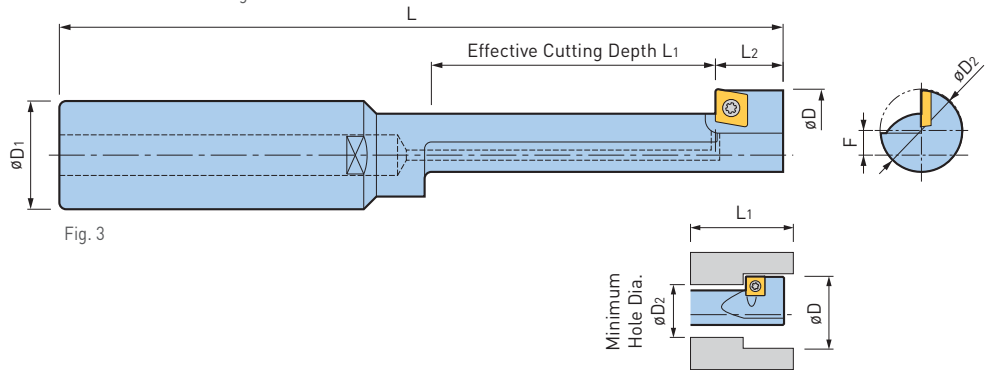
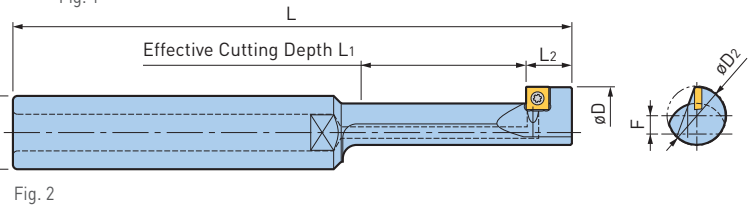
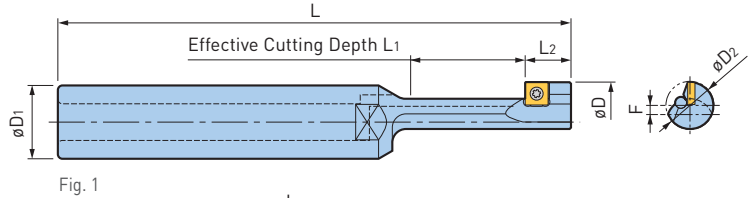
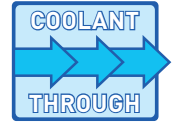

Catalog Number	Fig.	Facing $\varnothing D$	$\varnothing D1$	Min Hole Dia. $\varnothing D2$	L	L1	L2	Offset F	Insert Model
ST16-BFM6/11-12	1	.433	16mm	.256	4.016	.472	.354	.094	CM0502
-BFM8/14-20		.551		.335	4.252	.787		.114	
-BFM10/17.5-25		.689		.413	4.409	.984		.144	
-BFM12/20-36		.787		.512	4.803	1.417		.144	
ST20-BFM14/23-49	2	.906	20mm	.591	5.354	1.929	.394	.163	CM0502
-BFM16/26-56		1.024		.669	5.591	2.205		.183	
ST32-BFM18/29-63	3	1.142	32mm	.748	7.402	2.480	.590	.205	CC□□07..
-BFM20/32-70		1.260		.827	7.677	2.756		.224	
-BFM22/35-77		1.378		.906	7.953	3.031		.244	
-BFM24/39-84		1.535		.984	8.425	3.307	.287	CC□□09..	
-BFM27/43-95		1.693		1.181	8.858	3.740	.268		
-BFM30/48-105		1.890		1.299	9.252	4.134	.307		

• Wrench and screws are included, inserts must be ordered separately

ACCESSORIES



BF-CUTTER—INDEXABLE INSERTS

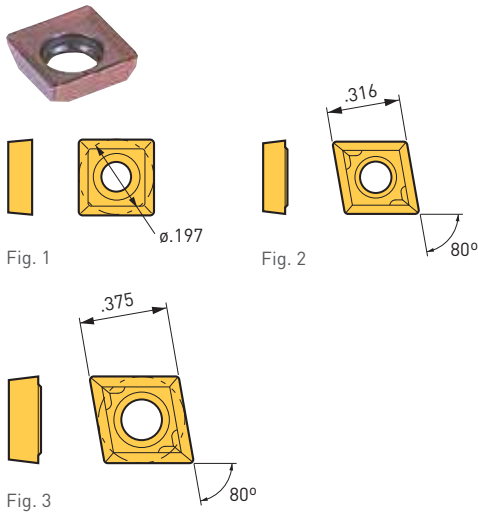

- Inserts are available in packages of 10 pcs.
- Please clarify the insert model and grade when ordering (ex: CM0502ACP200)

Insert Model	Fig.	Nose Radius	Material	Insert Grade		
CM0502	1	.008	General Steel	ACP200		
			Stainless Steel	ACM250F		
			Aluminum/Non-Ferrous	DS20		
CCGP070204EFM	2	.016	General Steel	T1500A		
CCMP070204EFM				AC820P		
CCMP070204EFM				AC830P		
CCMP070204ESM			Stainless Steel	AC630M		
CCMP070204EFM			Cast Iron	AC700G		
CCMP070204EFM			Cast iron/Aluminum/ Non-Ferrous	AC410K		
CCGA070204FN				H1		
CCGM090308EFM			3	.031	General Steel	T1500A
CCMM090308EFM						AC820P
CCMM090308EFM	AC830P					
CCMM090308ESM	Stainless Steel	AC630M				
CCMM090308EFM	Cast Iron	AC700G				
CCMM090308EFM	Cast iron/Aluminum/Non-Ferrous	AC410K				

INSERT CLASSIFICATIONS

ACP200	ACM250F	DS20	T1500A	AC820P	AC830P
For general steel	For stainless steel	For aluminum/non-ferrous	For general steel	For general steel	For general steel
PVD-coated carbide with superior wear resistance due to its nanometer-level thickness ultra-multilayered TiAlN and AlCrN film.	PVD-coated carbide with excellent smoothness and resistance to welding and chipping, due to the ultra-multilayered thin film structure made of AlTiN and TiAlCrN.	DLC-coated carbide exclusive for aluminum and non-ferrous metals, ultra-smooth with a low wear coefficient and superior welding resistance.	General purpose cermet for applications in regions from finishing to roughing. Special technology improves the material's resistance to thermal shock, allowing safe use even for wet machining.	The newly developed CVD method allows for a dense yet smooth coating that achieves outstanding versatility and consistency as the main material for steel.	The tough substrate and the peel-resistant, dense and smooth coating deliver high reliability for interrupted cutting of steel.

AC630M	AC700G	AC410K	H1
For stainless steel	For cast iron	For cast iron/aluminum/non-ferrous	For cast iron/aluminum/non-ferrous
The extremely smooth thin film coating gives this material great sharpness. Ideal for stainless steel or other materials that are easily work hardened.	Heat resistant carbide alloy is coated with multiple layers of mainly tough alumina, with additional surface smoothing treatment, to produce a highly reliable material for machining cast iron.	The hardest material for cast iron. Use if not satisfied with the wear resistance of AC700G. Note that this type is not suitable for heavy duty interrupted cutting.	With slightly higher wear resistance than K10 material, this material is a best selling type of carbide that can be used across a wide range from roughing to finishing.

SPARE PARTS









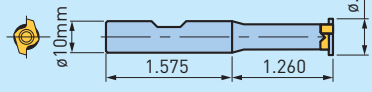
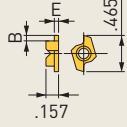

Cutter Type	Insert Clamping Screw Set
BFM6/11	S2SS-T6
BFM8/14	
BFM10/17.5	
BFM12/20	S2TS-T6
BFM14/23	
BFM16/26	
BFM18/29	S3S
BFM20/32	
BFM22/35	
BFM24/39	S4S-T15
BFM27/43	
BFM30/48	

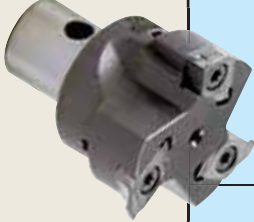
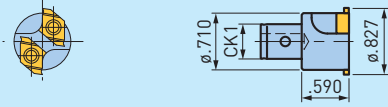
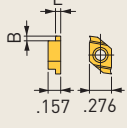
RECOMMENDED CUTTING CONDITIONS

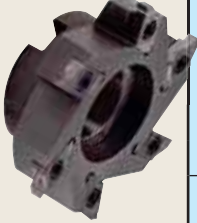
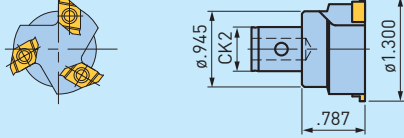
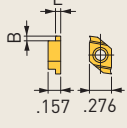
Material	Cutting Speed (SFM)	Feed (IPT)
Carbon/Alloy Steel	100	.001
Cast Iron		
Aluminum/Non-Ferrous Material	100-165	

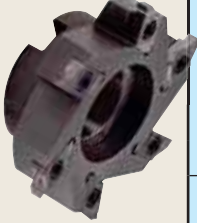
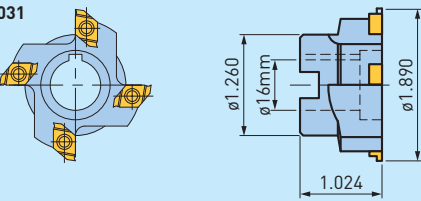
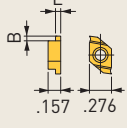
GROOVE MILLING CUTTERS WITH CARBIDE INSERTS

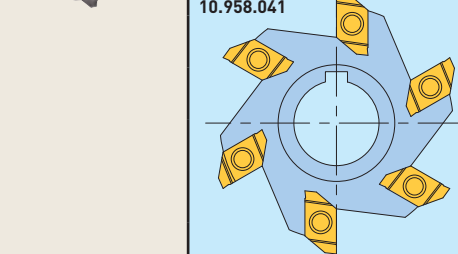
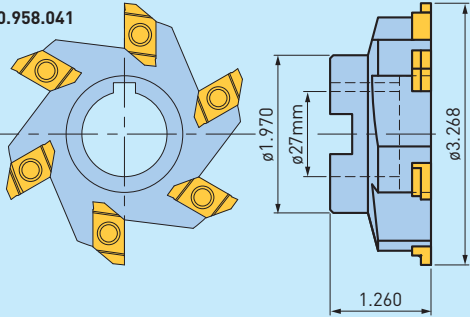
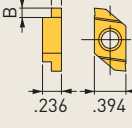
Designed for Circular Milling of Internal or External Grooves.



	Catalog Number	Insert Type	E	B	Boring Range	Application Code	Catalog Number						
 <p>10.958.008</p> 		Type 0 	.045	.027	.472-.945	ST	10.958.051						
						CI	10.958.052						
						AL	10.958.053						
						-	-	-		10.958.048			
									.053	.039	.472-.945	ST	10.958.055
												CI	10.958.056
			AL	10.958.057									
			 <p>10.958.010</p> 		Type 1 	.045	.027	.866-1.340	ST	10.958.061			
CI	10.958.062												
AL	10.958.063												
						-	-	-		10.958.048			
									.053	.039	.866-1.340	ST	10.958.065
												CI	10.958.066
AL	10.958.067												
 <p>10.958.021</p> 		Type 1 				.065	.043	1.340-1.970	ST	10.958.071			
			CI	10.958.072									
			AL	10.958.073									
						-	-	-		10.958.048			
									.075	.055	1.340-1.970	ST	10.958.075
												CI	10.958.076
			AL	10.958.077									
			 <p>10.958.031</p> 		Type 1 	.087	.063	1.970-3.350	ST	10.958.081			
CI	10.958.082												
AL	10.958.083												
						-	-	-		10.958.048			
									.106	.075	1.970-3.350	ST	10.958.085
												CI	10.958.086
AL	10.958.087												
 <p>10.958.041</p> 		Type 2 				.126	.082	3.350-8.270	ST	10.958.091			
			CI	10.958.092									
			AL	10.958.093									
						-	-	-		10.958.049			
									.165	.098	3.350-8.270	ST	10.958.095
												CI	10.958.096
			AL	10.958.097									

APPLICATION CODES

CI Cast Iron
ST Steel
AL Aluminum
 Clamping Screw (10 screws & 1 wrench)

BLANK INSERTS

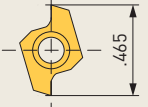
Periphery ground without rake angle and chip breakers.

Type 0	Grade	Catalog Number	Type 1	Grade	Catalog Number	Type 2	Grade	Catalog Number
 E Max .157 B Max .039	C3	10.958.313	 E Max .157 B Max .075 .276	C3	10.958.157	 E Max .236 B Max .098 .394	C3	10.958.155
	C5	10.958.314		C5	10.958.158		C5	10.958.156

TECHNICAL INFORMATION:

In all circular milling operations the programmed feed rate S applies to the center of the milling cutter. This may be computed as follows:

$$S = S1 \times \frac{D-d}{D}$$

Where:
 S = Feed rate for cutter center to be programmed in in/min
 S1 = Circumferential feed in in/min from table
 D = Bore diameter

SPEEDS & FEEDS

Cutter Dia.	Cutter Speed & Feed			
	Steel: 328 SFM	Cast Iron: 427 SFM	Alum.: 591 SFM	
.827	Speed	1500 RPM	2000 RPM	2700 RPM
	S1	11.8 IPM	15.7 IPM	21.3 IPM
1.299	Speed	1000 RPM	1300 RPM	1800 RPM
	S1	11.8 IPM	15.4 IPM	21.3 IPM
1.890	Speed	650 RPM	850 RPM	1200 RPM
	S1	10.2 IPM	13.4 IPM	18.9 IPM
3.268	Speed	380 RPM	500 RPM	700 RPM
	S1	9.0 IPM	11.8 IPM	16.5 IPM

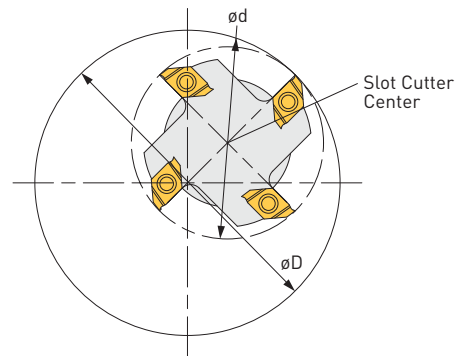

These values relate to the milling cutter circumference and apply under normal working conditions. Climb-cut milling is recommended with helical or tangential plunging to groove depth assuming a continuous program cycle without feed interruption.

MEASURING TOOLS & ACCESSORIES

D.1



MEASURING INSTRUMENTS
596-614

POINT MASTER PRO	596-600
BASE MASTER	602-604
TOOL MASTER	604
3D MASTER RED	605
ACCU CENTER	605
ATC ALIGNMENT TOOL	606
DYNA FORCE	607
DYNA LINE	608-609
DYNA CONTACT	610
LEVEL MASTER	611
DIAL INDICATOR STANDS	612-614

TOOL ASSEMBLY DEVICES
615-619

TOOL PRO	615
KOMBI GRIP	616
ST LOCK	616
TOOLING MATE	617-618
TORQUE FIT	619

CLEANERS
620-623

TOOLING CLEANER	620
HSK EXTERNAL TAPER CLEANER	620
SPINDLE CLEANERS	621
CHIPFAN	622
T-SLOT CLEAN	623

POINT MASTER PRO—PMPC SERIES
Touch Probe & Edge Finder

Instantaneously detects reference points even on non-conductive workpieces and machines. Notification of touchpoint with LED and beep.



For All Workpieces and Machine Tools



Notifies Via Buzzer

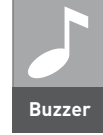

Notifies Via Led



LED Flashes To Indicate That Battery Life Is Low

CYLINDRICAL SHANK TYPE



Catalog Number	øDh7	L	L1	Weight (lbs.)
PMPC-20	20mm	3.937	1.969	1.1
PMPC-32	32mm	3.543	2.362	1.5

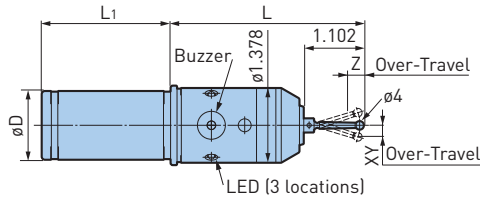

ACCESSORIES



- ST28-4R stylus is included

BBT SHANK TYPE



Catalog Number	Fig.	L	L1	Weight (lbs.)
BBT30-PMPC-115	1	4.528	2.480	1.76
BBT40-PMPC-120	2	4.724	3.661	2.86

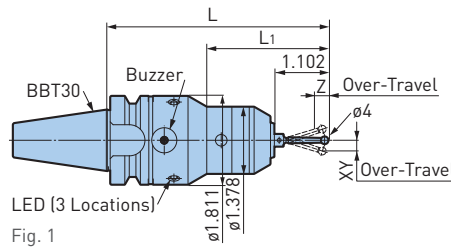

Fig. 1

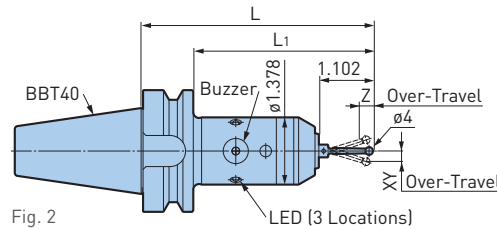

Fig. 2

ACCESSORIES



- ST28-4R stylus is included

SPECIFICATIONS

Repeatability	±1µm (.00004")	
Over-Travel	XY ±12mm Z 5mm (XY±.472" Z.197")	
Measuring pressure	XY 0.4N Z 1.5N	
Battery	PMPC-20, 32	LR1 x 2P
	BBT40-PMPC-120	
	BBT30-PMPC-115	CR2 x 1
Battery Life	PMPC-20, 32	280 Continuous Hours
	BBT40-PMPC-120	
	BBT30-PMPC-115	260 Continuous Hours

- The specifications above are values when ST28-4R stylus is used
- Repeatability is affected by stylus length
- There is a delay of approx. 5µm in XY direction and 2µm in Z direction when the stylus contacts the workpiece measuring surface to illuminate the LED

POINT MASTER PRO—PMP SERIES

Ideal for high-speed machining centers with ceramic bearings.

CYLINDRICAL SHANK TYPE

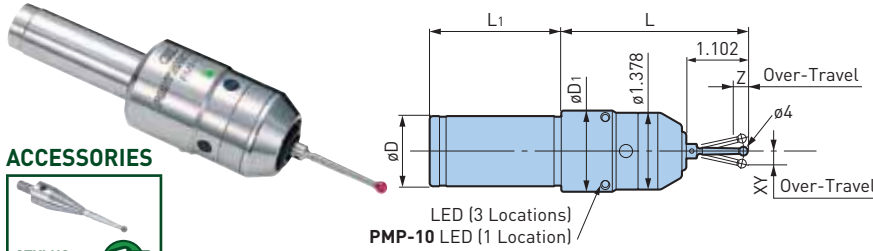

ACCESSORIES



For All Workpieces and Machine Tools



LED Flashes To Indicate That Battery Life Is Low

Catalog Number	øD _{H7}	øD ₁	L	L ₁	Weight (lbs.)
PMP-10	10mm	1.378	2.953	1.929	.9
PMP-20	20mm	1.457	3.543	1.969	1.1
PMP-32	32mm		3.150	2.362	1.3

• ST28-4R stylus is included

BBT SHANK TYPE

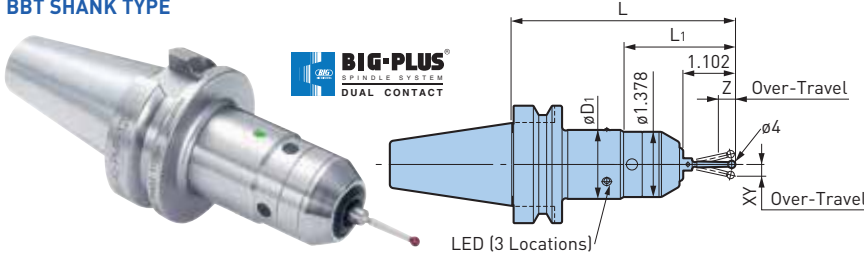

Catalog Number	øD ₁	L	L ₁	Weight (lbs.)
BBT30-PMP-115	1.811	4.528	2.480	1.8
BBT40-PMP-120	1.457	4.724	2.362	2.9
BBT50-PMP-150	1.457	5.906	2.362	8.4

• ST28-4R stylus is included

ACCESSORIES



HSK-A63 SHANK TYPE (DIN 69893-1 & ISO 12164)

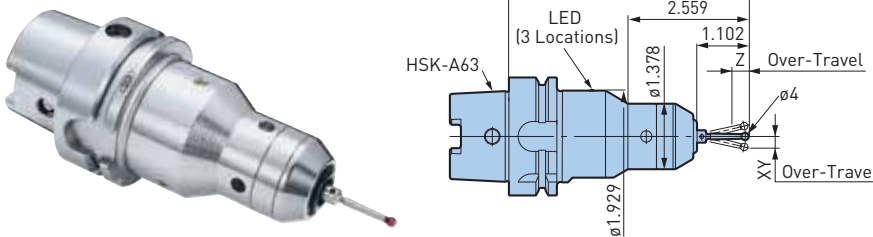

Catalog Number	Weight (lbs.)
HSK-A63-PMP-130	2.9

• ST28-4R stylus is included

HSK-E32 SHANK TYPE (DIN 69893-5)

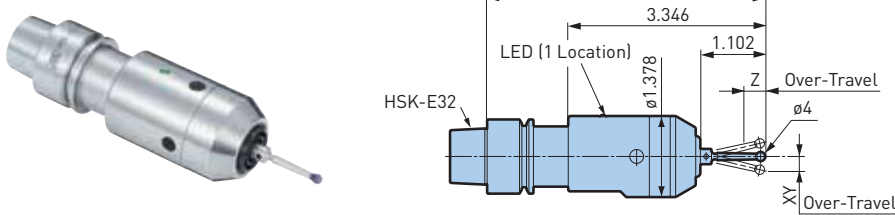

Catalog Number	Weight (lbs.)
HSK-E32-PMP-120	1.1

• ST28-4R stylus is included

ACCESSORIES



SPECIFICATIONS





Repeatability	±1µm (.00004")	
Over-Travel	XY ±12mm Z 5mm (XY ±.472" Z.197")	
Measuring Pressure	XY .4N Z 1.5N	
Battery	PMP-10	Panasonic Lithium Battery BR435 x 1P
	PMP-20, 32 BBT40-PMP-120	LR1 x 2P
	HSK-A63-PMP-130 BBT30-PMP-115	CR2 x 1
	HSK-E32-PMP-120	SR44 x 2P
	BBT50-PMP-150	LR03 x 2P

Battery life	PMP-10	180 continuous hours
	PMP-20, 32 BBT40-PMP-120	500 continuous hours
	HSK-A63-PMP-130 BBT30-PMP-115	900 continuous hours
	HSK-E32-PMP-120	90 continuous hours
	BBT50-PMP-150	600 continuous hours

- The specifications above are values when ST28-4R stylus is used.
- Repeatability is affected by stylus length.
- There is a delay of approx. 5µm in XY direction and 2µm in Z direction when the stylus contacts the workpiece measuring surface to illuminate the LED.

POINT MASTER PRO—PMC SERIES

Instantaneous detection with LED and beep. LED flashes to notify low battery life while measuring workpieces.

 Conductivity	For use with conductive workpieces and machine tools	 Battery Alarm	Notifies Via Buzzer	 Buzzer	Notifies Via Led	 LED	LED Flashes To Indicate That Battery Life Is Low
--	--	---	---------------------	--	------------------	---	--

CYLINDRICAL SHANK TYPE

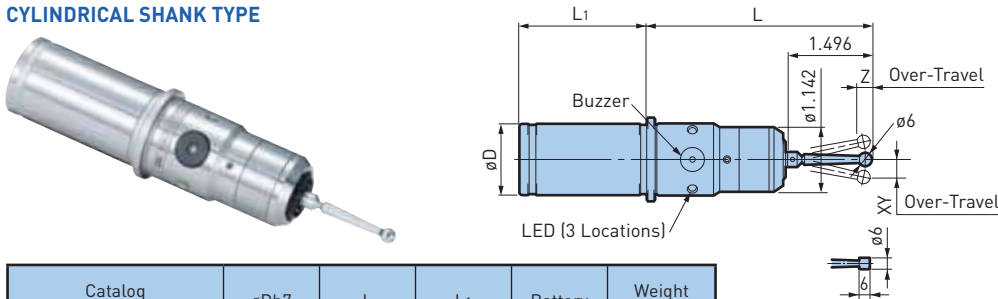

Catalog Number	øDh7	L	L1	Battery	Weight (lbs.)
PMC-20	20mm	4.331	1.969	LR1x2	.88
-20S					
-32	32mm	4.016	2.283	LR1x2	1.32
-32S					

ACCESSORIES



- **ST38-6P** stylus is included. Models with an S at the end of the model number include ø6 cylindrical ST38-6X6 stylus
- Cannot be used with non-conductive workpieces and machines with ceramic bearings, use POINT MASTER PRO

BBT SHANK TYPE

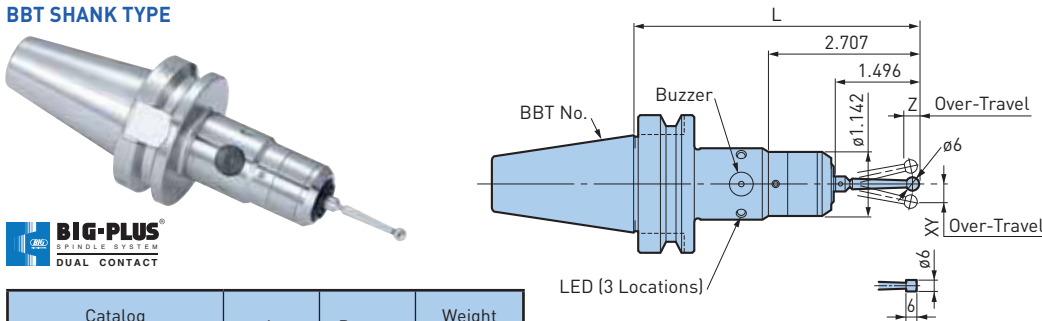

Catalog Number	L	Battery	Weight (lbs.)
BBT40-PMC-130	5.118	LR1x2	2.64
-PMC-130S			
BBT50-PMC-160	6.300	LR03x2	8.8
-PMC-160S			

ACCESSORIES



- **ST38-6P** stylus is included. Models with an S at the end of the model number include ø6 cylindrical ST38-6X6 stylus
- Cannot be used with non-conductive workpieces and machines with ceramic bearings. Use POINT MASTER PRO

SPECIFICATIONS

Probe Repeatability	±1µm (.00004")	
Over-Travel	XY ±12mm Z 5mm (XY ±1.472" Z .197")	
Measuring Pressure	XY 0.6N	Z 2.7N
Battery Life	PMC-20, 20S, 32, 32S	300 continuous hours
	BBT40-PMC-130, 130S	
	BBT50-PMC-160, 160S	

- The specifications above are values when the standard accessory stylus is used

CAUTION 

Pullstud bolts with a center through hole cannot be used. In the case of machines that require a hole on the pullstud bolts due to the coolant nozzle, please contact BIG KAISER.

POINT MASTER PRO—PMG SERIES

Instantaneous detection with LED.



For use with
conductive
workpieces
and machine
tools



LED Flashes
To Indicate
That
Battery Life
Is Low

CYLINDRICAL SHANK TYPE

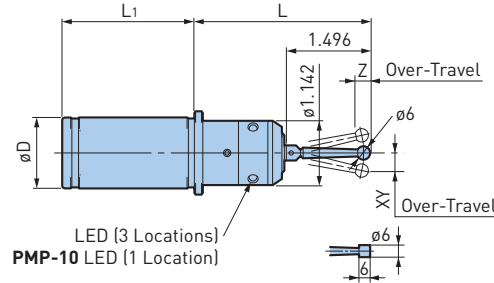

Catalog Number	øDh7	L	L1	Battery	Weight (lbs.)
PMG-10	10mm	2.953	1.969	Panasonic Lithium BR435 x 1	.44
-10S					
-20	20mm	3.543	1.969	LR1x2	.66
-20S					
-.750	.750				
-32	32mm	3.150	2.362	LR1x2	1.1
-32S					

ACCESSORIES



- **ST38-6P** stylus is included, except for PMG-.750, ST38-.25P (1/4")
- Models with an S at the end of the model number include ø6 cylindrical ST38-6X6 stylus

MORSE TAPER TYPE

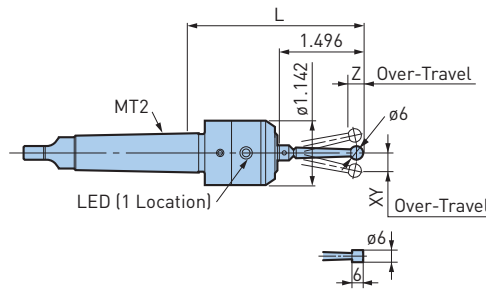

Catalog Number	MT	L	Battery	Weight (lbs.)
PMG-MT2	MT2	3.150	Panasonic Lithium BR435 x 1	.44
-MT2S				

ACCESSORIES



- LED in 1 location only
- **ST38-6P** stylus is included. Model with an S at the end of the model number includes ø6 cylindrical ST38-6X6 stylus

SPECIFICATIONS

Probe Repeatability	±1µm (.00004")	
Over-Travel	XY ±12mm Z 5mm (XY ±.472" Z .197")	
Measuring Pressure	XY 0.6N	Z 2.7N
Battery Life	PMG-20, 20S, .750, 32, 32S	80 continuous hours
	PMG-10, 10S, MT2, MT2S	150 continuous hours

- The specifications above are values when the standard accessory stylus is used

REPLACEABLE STYLUS (OPTIONAL PRODUCT)

For PMPC, PMP, PMC, PMG Series

M3 thread is used to make the stylus replaceable, allowing replacement if it is damaged or according to the workpiece shape.

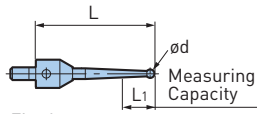

Fig. 1

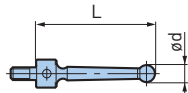

Fig. 2

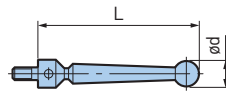

Fig. 3

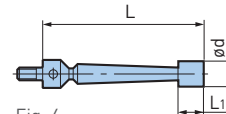
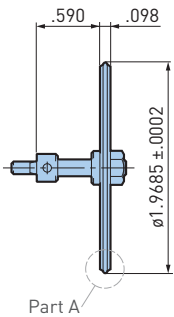

Fig. 4

Catalog Number	Fig.	L	L1	ød	Weight (g)	Stylus Tip	Point Master Model		
ST28-1P	1	1.102	.078	1mm	2.0	Carbide	PMG/PMC PMP/PMPC		
-2P			.315	2mm	2.0				
-3P	2		—	3mm	2.5				
-4P			—	4mm	2.9				
ST28-4R	2			4mm	2.6	Ruby	PMP/PMPC		
ST38-6P	3	1.496	—	6mm	4.8	Steel [SUS]	PMG/PMC		
ST38-.25P			—	.250"					
ST38-6x6	4			.236	6mm		4.8		PMG□□S/PMC□□S

• ST38-6 x 6 stylus is exclusive for PMG□□S/PMC□□S models, mounting on other models will negatively affect the runout accuracy

Ideal for measuring the taper of irregularly shaped workpieces or plastic molds.



PART A DETAILS

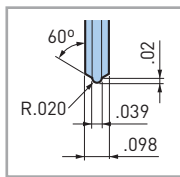

Catalog Number
ST15-50K



BASE MASTER

Electronic detection of the cutting edge position. Repeatability $\pm 1\mu\text{m}$ (.00004").

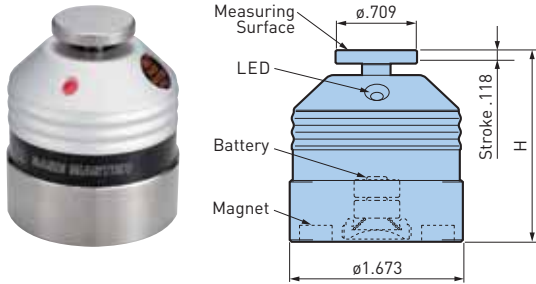

Catalog Number	H
BM-50	50mm
BM-2	2.000

- Type without magnets is also available, If required, add /N at the end of the model number when ordering (Example: BM-50/N)



For use with conductive workpieces and machine tools



LED Flashes To Indicate That Battery Life Is Low

Height accuracy	+0.005mm, 0 (.0002")
Repeatability	$\pm 1\mu\text{m}$ (.00004")
Min. Tool Diameter	$\phi 1\text{mm}$ (.04")
Measuring Pressure	3N
Stroke	3mm (.118")
Touch Signal	LED Illuminates (Red)
Battery	SR44 x 2
Battery Life	10 Continuous Hours
Weight	.5 lbs.

BASE MASTER GOLD

Electronic detection of the cutting edge position. Repeatability $\pm 1\mu\text{m}$ (.00004").

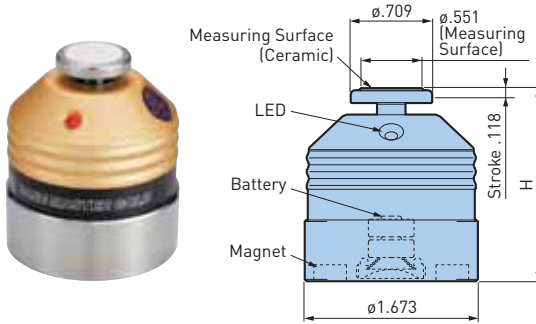

Catalog Number	H
BM-50G	50mm
BM-2G	2.000

- Type without magnets is also available, If required, add /N at the end of the model number when ordering (Example: BM-50G/N)



For All Workpieces and Machine Tools



LED Flashes To Indicate That Battery Life Is Low

Height accuracy	+0.005mm, 0 (+.00004", -0)
Repeatability	$\pm 1\mu\text{m}$ (.00004")
Min. Tool Diameter	$\phi 1\text{mm}$ (.040")
Measuring Pressure	2N
Stroke	3mm (.118")
Touch Signal	LED Illuminates (Red)
Battery	SR44 x 2
Battery Life	10 Continuous Hours
Weight	.5 lbs.

Easily Visible Measuring Surface, Even With Large Machines!

Cutting edge detection position of 100mm from machining object top surface.

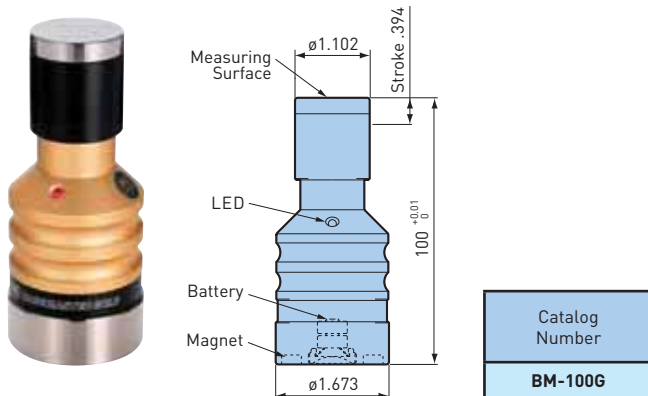

Catalog Number
BM-100G

- Type without magnets is also available, If required, add /N at the end of the model number when ordering (Example: BM-100G/N)



For All Workpieces and Machine Tools



LED Flashes To Indicate That Battery Life Is Low

Height Accuracy	100 +0.01mm 0
Repeatability	$\pm 1\mu\text{m}$ (.00004")
Min. Tool Diameter	$\phi 1\text{mm}$ (.04")
Measuring Pressure	2N
Stroke	10mm (.394")
Touch Signal	LED Illuminates (Red)
Battery	SR44 x 2
Battery Life	10 Continuous Hours
Weight	.80 lbs.

BASE MASTER RED

Independent body and measurement part. DLC coated Sensor Plate. Safe stroke amount of 5mm.

BODY SET

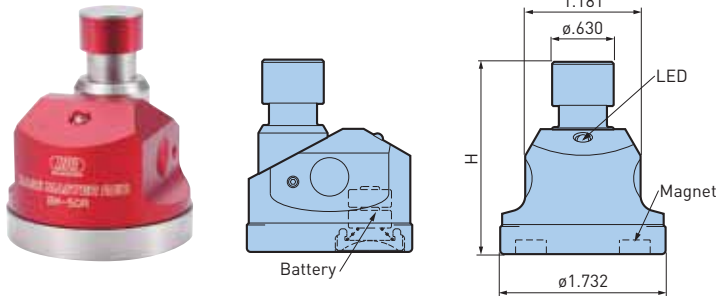

Catalog Number	H
BM-50R	50mm
BM-2R	2.000

• Measurement part (BM-MEG) is included



For All Workpieces and Machine Tools



LED Flashes To Indicate That Battery Life Is Low

Height Accuracy	+0.01mm, 0 (+.0004", 0)
Repeatability	±1µm (.00004")
Min. Tool Diameter	ø1mm (.04")
Measuring Pressure	2N
Stroke	5mm (.197")
Touch Signal	LED Illuminates (Red)
Battery	SR44 x 2
Battery Life	10 Continuous Hours
Weight	.44 lbs.

MEASUREMENT PART ONLY

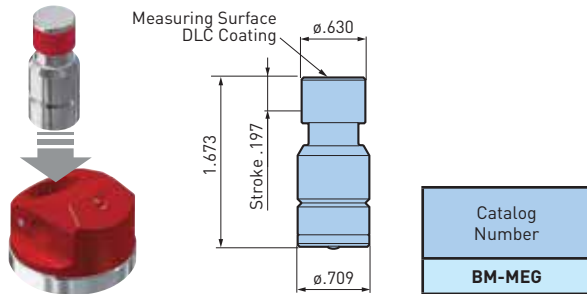

• Measurement part is also available separately

BASE MASTER MICRO

Cutting edge position detection of ø.05mm (ø.002") tool. Low-contact pressure cushion mechanism realizes measurement of ultra-small tools.

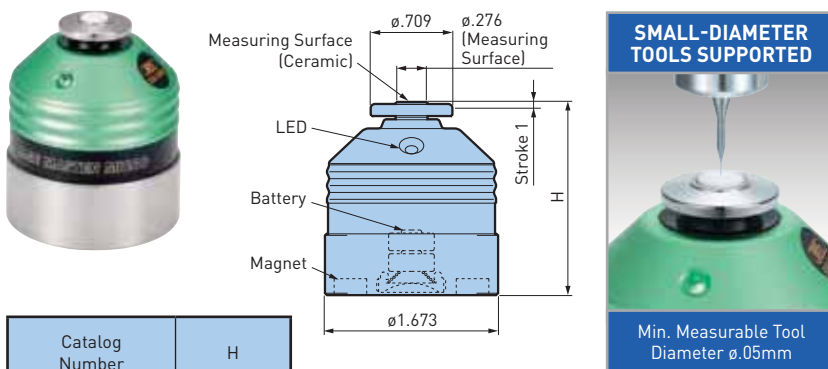

Catalog Number	H
BM-50M	50mm
BM-2M	2.000



For All Workpieces and Machine Tools



LED Flashes To Indicate That Battery Life Is Low

Height Accuracy	+0.005mm, 0 (+.0002", -0)
Repeatability	±1µm (.00004")
Min. Tool Diameter	ø.05mm (.002")
Measuring Pressure	.3N
Stroke	1mm (.040")
Touch Signal	LED Illuminates (Green)
Battery	SR44 x 2
Battery Life	10 Continuous Hours
Weight	.53 lbs.

• Type without magnets is also available. If required, add /N at the end of the model number when ordering. (Example: BM-50M/N)

BASE MASTER MINI—ULTRA-THIN TYPE

- Cutting edge position measuring device with a reference height of 10mm.
- Ultra-compact design considering tool interference prevention.
- High brightness LED (green) lights to instantly detect the reference point.

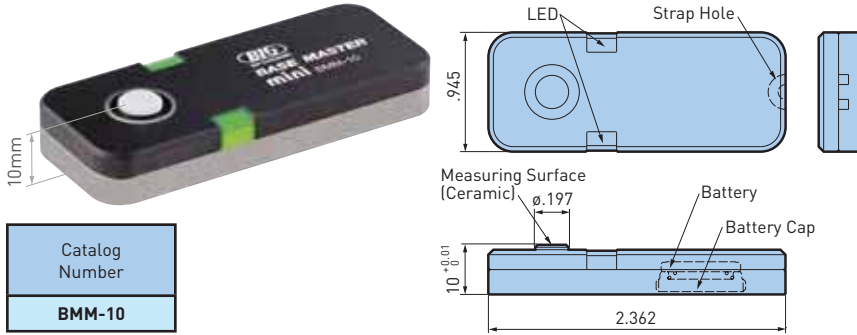

Catalog Number
BMM-10



For All Workpieces and Machine Tools



LED Flashes To Indicate That Battery Life Is Low

Height Accuracy	+0.005mm 0
Repeatability	±1µm
Min. Tool Diameter	ø0.1mm
Measuring Pressure	1.0N
Stroke	1mm
Touch Signal	LED Illuminates (Green)
Battery	CR1620x1
Battery Life	10 Continuous Hours
Weight	.02 lbs.

BASE MASTER MINI

Electronic detection of the cutting edge position. Repeatability ±1µm (.00004").

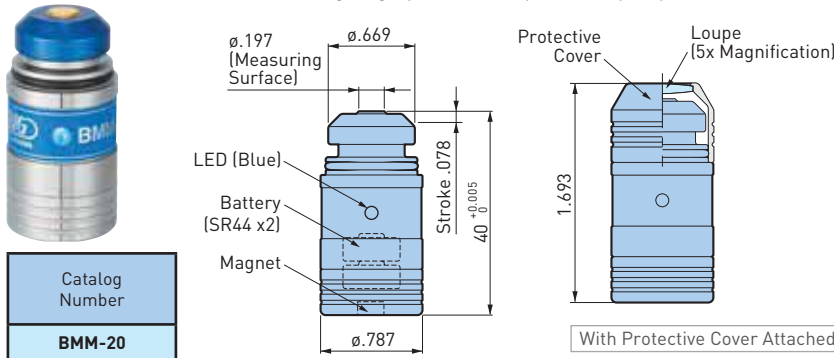

Catalog Number
BMM-20



For All Workpieces and Machine Tools



LED Flashes To Indicate That Battery Life Is Low

Height Accuracy	+0.005mm 0
Repeatability	±1µm
Min. Tool Diameter	ø.1mm
Measuring Pressure	1.8N
Stroke	2mm
Touch Signal	LED Illuminates (Blue)
Battery	SR44 x 2
Battery Life	10 Continuous Hours
Weight	.12 lbs.

- Wrench for battery cap is included
- Type without magnets is also available, If required, add /N at the end of the model number when ordering [Example: BM-50/N]

TOOL MASTER

Non-Conductive Workpieces and Tools can Also be Measured!

Uses a large, easily read dial (with buzzer and LED), one-touch height adjustment mechanism and a firmly fixed powerful magnet.

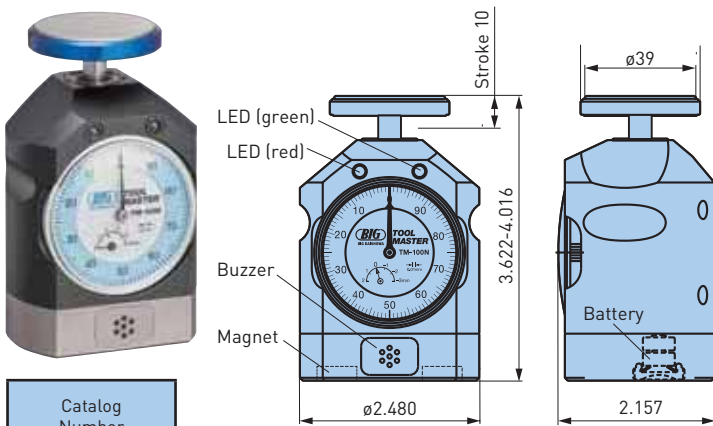

Catalog Number
TM-100N

- Dial gauge accuracy conforms to JIS B7503:2011.
- Type without magnets is also available, If required, add /N at the end of the model number when ordering [Example: TM-100/N]



For All Workpieces and Machine Tools



LED Flashes To Indicate That Battery Life Is Low



Notifies Via Led

Height Accuracy	100 ±.02/0mm		
Min. Tool Diameter	ø1mm		
Measuring Pressure	3N (at 100mm)		
Stroke	10mm		
Stroke Range	97-102mm		
Notification Signal	Around 100.5mm	LED	Lit (Green)
		Buzzer	"Beep"
	Around 99.5mm	LED	Flashing (Green/Red)
		Buzzer	"Beep Beep Beep"
Battery	SR44 x 2		
Weight	2.2 lbs.		
Standard Accessory	Setting Gauge x 1P		
Dial Gauge Accuracy	Min. Scale	.01mm	
	Indicator Error	±15µm	
	Repeatability	5µm	
	Return Error	5µm	

3D MASTER RED

All-Rounder Dial-Type Reference Position Measuring Instrument

- Available for non-conductive workpieces
- Measure XY & Z directions
- Calculation of the stylus ball radius not required



For All Workpieces and Machine Tools

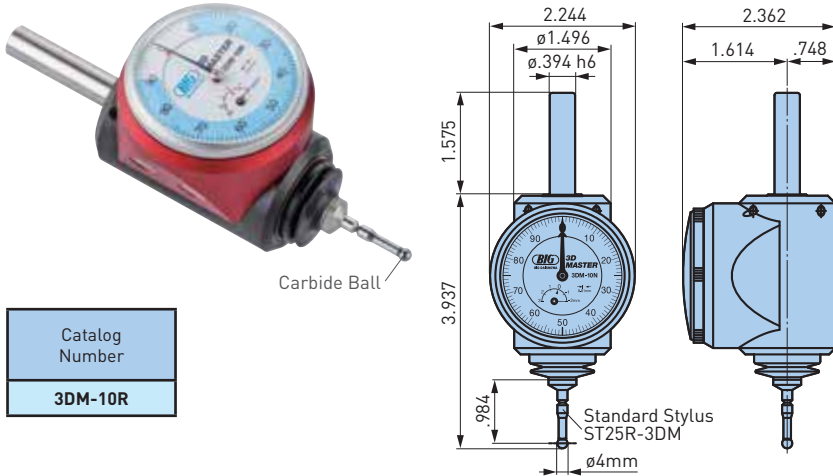

Catalog Number
3DM-10R

Min. Scale	.01mm
Repeatability	Within .01mm
XY Stroke	±4mm
Z Stroke	4mm
Protection Rating	IP67
Weight	1.3 lbs.
Accessory	Stylus ST25R-3DM

ACCU CENTER

Simple mechanical design for high-precision positioning!

- Just touch the stylus to the workpiece surface to complete measurement
- Repeatability within 3µm (when used on vertical machines)
- Hard chrome plated stylus for superior durability

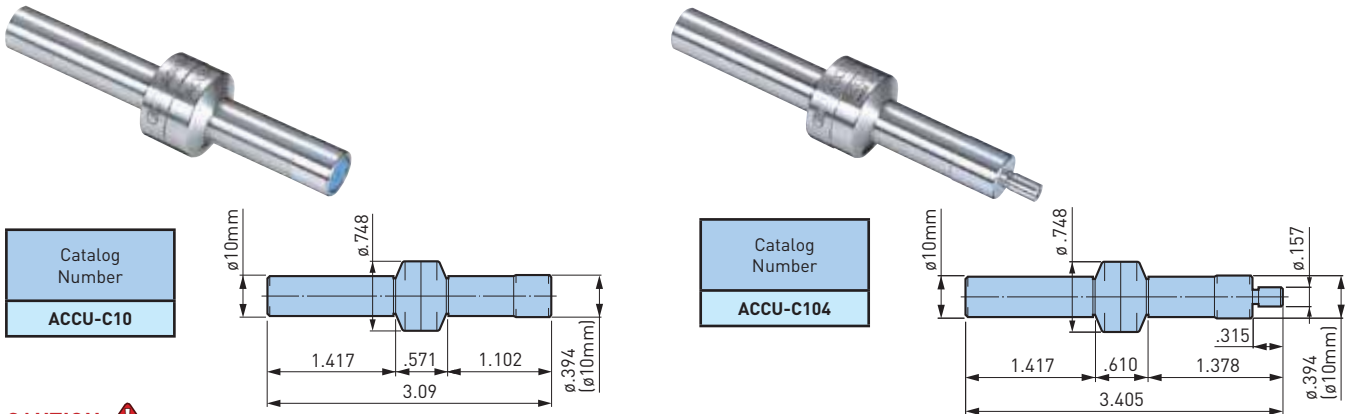

CAUTION

Not suitable for horizontal type machines.

OPERATION INSTRUCTIONS

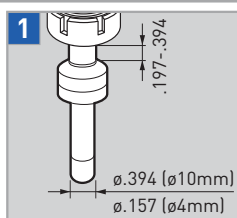

Mount the ø10 straight part to a Milling Chuck or New Baby Chuck.

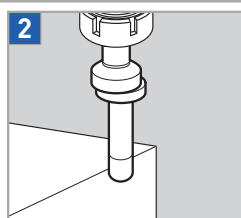

Press the stylus lightly with fingers to move off center and rotate at 400-600 RPM.

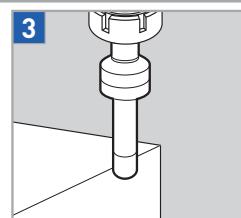

Touch the stylus to the workpiece; its runout will gradually decrease and it will seem to come to a stop.

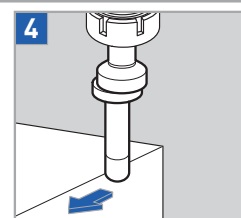

Apply finer feed and keep the stylus in contact; it will begin to slide in one direction. Where it begins to slide, compensate the position by radius of the stylus 5mm (2mm) to detect the reference position.



ATC ALIGNMENT TOOL

Misalignment of the center between the machine tool spindle and ATC gripper may cause damage to the spindle taper when a tool holder is loaded into the spindle. A clamped tool holder under misalignment leads to increased runout, resulting in shorter life of machine tools and tool holders, as well as cutting tools. The ATC Alignment Tool can also be used for re-aligning the ATC gripper and tool magazine pots. Overall cost reduction is achieved by using equipment in good condition.

How To Use

1. Load the AL Shank in the machine spindle and mount the AL Flange on the ATC arm.
2. Insert the AL Plug into the AL Flange.
3. Rotate the AL Plug and read the highest and lowest values of the dial indicator. This direction is the eccentric direction. Half of the gap of the values is the eccentric amount.
4. Adjust the position of the ATC arm so that the front end of the AL Plug will be inserted into the AL Flange fully.

Provided with ATC Alignment Tool & Plastic Storage Case

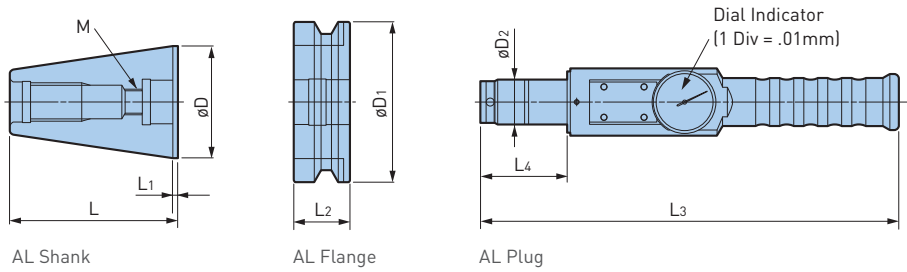

CV TAPER

Catalog Number	ϕD	D1	D2	L	L1	L2	L3	L4	M
CV40-ATC20	1.75	2.500	.787	2.812	.123	.958	9.882	1.732	1/2"-13
CV50-ATC28	2.75	3.875	1.102	4.125	.123	1.301	10.276	2.126	5/8"-11

• DIN 7/24 taper spindle models available

BT TAPER

Catalog Number	ϕD	D1	D2	L	L1	L2	L3	L4	M
BT30-ATC18	31.75mm	46mm	18mm	50.4mm	2mm	20mm	251mm	44mm	12mm
BT40-ATC20	44.45mm	63mm	20mm	67.4mm	2mm	25mm	251mm	44mm	12mm
BT50-ATC28	69.85mm	100mm	28mm	104.8mm	3mm	35mm	261mm	54mm	16mm

DYNA FORCE

Machine tool maintenance is a necessity. Periodical measurement of the spindle retention force avoids unknown reduced rigidity, which leads to vibrations, loss of machining quality and shortened tool life. A full length taper stabilizes the value of measurements.

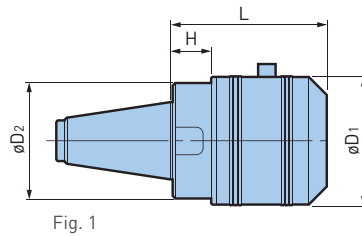
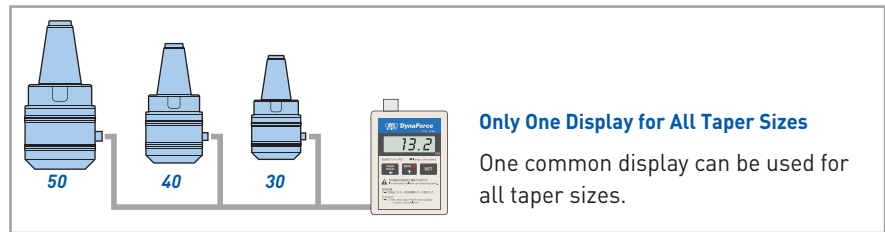

Fig. 1

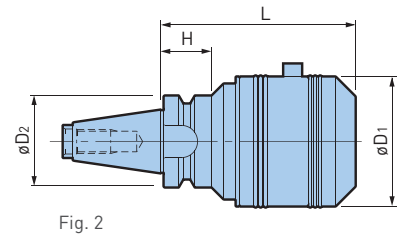

Fig. 2

Catalog Number	Contents of Set				Taper No.	Rated Capacity	øD1	øD2	L	H	Weight (lbs.)		
	Measuring Device	Fig.	Display	Cable									
SNT30-DF10	NT30-DF10	1	DFA-1 [AA battery x2]	DFC-1 (2m)	30	10 kN (980 kgf)	2.559	2.283	3.150	.787	3.3		
SBT30-DF10	BT30-DF10	2						1.811	2.858	1.024	3.5		
SNT40-DF30	NT40-DF30	1			50	50 kN (4,900 kgf)	3.780	3.543	3.543	4.331	1.299	13.2	
SNT50-DF50	NT50-DF50	1							2.874	2.756	3.386	.787	8.6
SNT50-DF30 ●	NT50-DF30	1							2.874	2.756	3.386	.787	8.6

- Each component is also available separately
- SBT30-DF10 is designed exclusively for machines not capable of automatic tool change
- SBT30-DF10 is suitable for BT/BBT30 machines only
- Pull stud bolt must be ordered separately, and for DIN, ISO, ANSI & CAT standard machines, an exclusive pull stud bolt for Dyna Force is required
- SNT50-DF30 marked ● indicates light-weight model
- Certificate of calibration and diagram of traceability system are available for a charge in order to maintain the reliability of the device



DYNA LINE

Precision Measuring of Tool Diameter and Runout Accuracy

Non-contact tool measuring equipment which uses a CMOS linear image sensor. It eliminates machining defects by measuring total runout accuracy at high rotation speeds. Also usable as a maintenance/evaluation tool for runout accuracy of a machine spindle.

- Non-contact measuring with CMOS linear image sensor
- In-machine measuring
- Portable (usable with 6 C-Cell batteries)

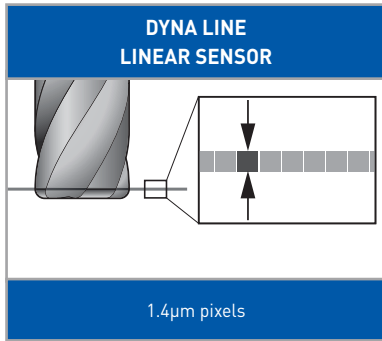
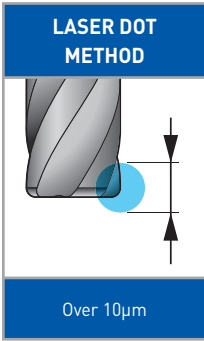

The Innovative Linear Image Measuring Method

CMOS sensors are often found in hi-tech equipment such as fax machines and banknote counters. With pixels measuring 1.4µm, Dyna Line uses the latest CMOS sensors for quick and precise measuring.



Measurement at High Rotation Speeds up to 1,300 SFM

- No potential of damage to delicate tools
- Measurement range: $\varnothing.004'' - \varnothing2.000''$ ($\varnothing.1-50\text{mm}$)
- Indicated resolution: 1µm
- Can run on 6 C-Cell batteries
- Able to measure tools with an odd number of teeth

Three Measurement Modes Depending on Type of Tool

$d \leq \varnothing4$

Cutting tool with less than $\varnothing4\text{mm}$

MODE

Max. 1,300 SFM

Simultaneously measures the tool diameter and runout accuracy of even-numbered flutes at processing rotation speed. Please refer to Pg. 609 for tools with an odd number of flutes.

$d > \varnothing4$

Cutting tool with more than $\varnothing4\text{mm}$

MODE

Max. 1,300 SFM

The machine spindle is offset the radius amount for tools larger than the detection range (4.2mm), and the edge of the tool is measured from the center of the sensor. Please refer to Pg. 609 for tools with an odd number of flutes.

Ex. — $\varnothing6\text{mm}$ End Mill

Spindle Offset: 3mm

Displayed Measurement Result: $+.002\text{mm}$

Diameter Includes the Runout of the Rotation:
 $(3 + .002\text{mm}) \times 2 = 6.004\text{mm}$

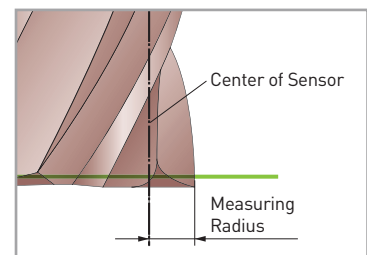
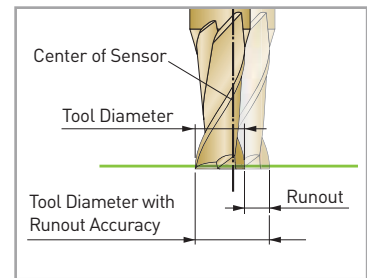

MEASUREMENT MODE SELECTION

Tool Diameter	Tool Type	Measurement Types	Mode	Rotation Speed
ø.004-ø.157 (ø.1mm-ø4mm)	Even Number of Flutes, Test Bar	Diameter, Runout	d ≤ ø4	Max. 1,300 SFM
	Odd Number of Flutes	Diameter		
ø.157-ø2.000 (ø4mm-ø50mm)	Tool	Diameter	d > ø4	Max. 1,300 SFM
		Runout	T.I.R.	20-150 RPM
	Test Bar	Diameter, Runout		

- It may not measure with unequal spacing

CONTROL PANEL

Results will be displayed on the control panel. Easy setting with simple use of buttons before measuring.

LED Indicator
Indicates position of tool.

Focus LED
A blue LED lights up when the tool is positioned at the optimal point of measurement.

Rotation Speed / Timer
A timer which can start measurement after shutting the MC door and tool rotation begins for safety. An option of 0-999 seconds is available.

Mode Select
To select measurement and setting mode.

Peak Hold
You can select Off, On, 5s and 10s as needed. (with 5s or 10s, it retains the maximum value for 5 or 10 seconds)

Eco Mode
Suppresses electricity usage. Use this function when you would like to save electricity. Using dry cell batteries will also help. (Please note that the rotation speed will be limited up to 660 SFM)

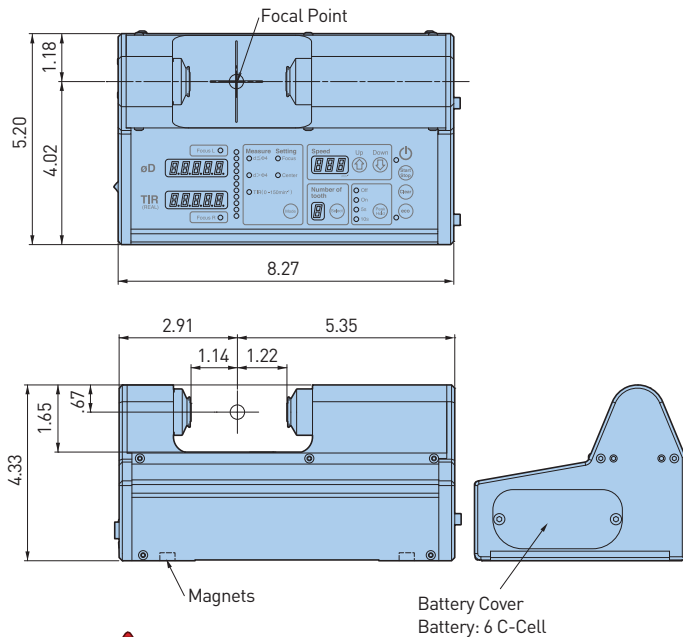

Catalog Number
DLX4-P

Detection Method	CMOS Linear Image Sensor
Light Source	LED
Indicated Resolution	1 µm
Repeatability	1 µm
Measurement Range	.004-2.000 (ø.1-50mm)
Detection Range	(ø.165 or More Must be Offset)
Ambient Temperature	32°-104°
Ambient Humidity	30-75% RH (No Condensation)
Power	AC100 ~ AC240V
Source	AC Adapter
	Dry Battery
Power Consumption	Normal Mode: 3 Hours
Battery Life	Eco Mode: 5 Hours
Weight	6.6 lbs. (Without Batteries)
Accessories	Setting Tool (Model: DCT-300) Protective Case, Edge Cleaner (Model: STP-EC)

CAUTION

Dyna Line is not completely waterproof. Please do not splash with coolant.

DYNA CONTACT

A ceramic taper gauge allowing inspection of machine spindle tapers at a glance.

- Made of ceramic
- Clearly shows up Prussian blue

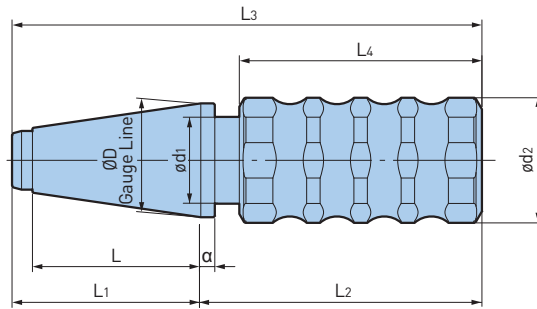

Taper Angle: 8° 17' 50" ±1"

Catalog Number	Taper Number	øD	ød1	ød2	L	L1	L2	L3	L4	a	Weight (lbs.)
DC-30P	30	1.250	.91	1.42	1.906	2.22	4.2	6.4	3.69	.236	1.14
-40P	40	1.750	1.34	1.93	2.575	2.89	4.4	7.2	3.74	.236	2.64
-50P	50	2.750	1.93	1.93	4.008	4.40	4.5	8.9	3.74	.315	5.76

- It can be used for BBT (BT=JISB6339), BDV (DV=DIN69871) and BCV (CV = ANSI)



LEVEL MASTER

2-axis simultaneous detection leveler. LED displays level conditions for both axis simultaneously. LED and buzzer indication when leveling is completed.



STANDARD TYPE



Catalog Number
LVM-01

WIRELESS TYPE



Catalog Number
LVM-WL

Simultaneous 2-Axis Detection Saves The Extra Time & Cost Of Using 2 Levelers

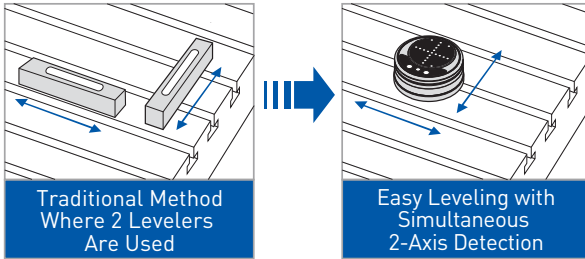

LED and Buzzer Indicates Leveling Completion

HIGH MODE

When the required level condition is **within .01mm/m**

LOW MODE

When the required level condition is **within .1mm/m**

Led (Blue) & Buzzer are Simultaneously Activated

Remote Work Solution Wireless Type

Easy and quick leveling with a single operator.

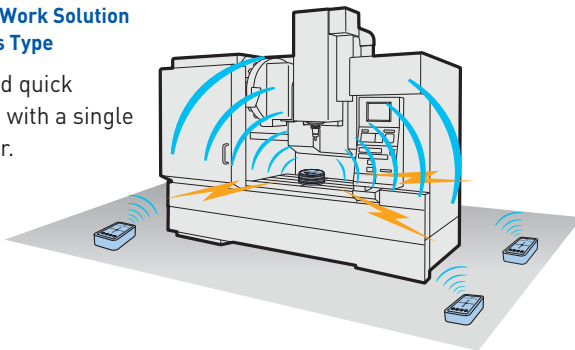

Provided with Level Master, Aluminum Storage Case, Alkaline Batteries (AAA x 4 pcs.), Manual, Guarantee Certificate & Inspection Sheet



	LVM-01	LVM-WL	
		Body	Receiver
Minimum Read Value	.01mm Inclination/m	.01mm Inclination/m	
Power Source	Alkaline batteries (AAA x 4 pcs)	Alkaline batteries (AAA x 4 pcs)	
Auto Power Off	30 minutes after power is turned on	30 minutes after power is turned on	
Operational Temperature	32-104° F (Recommended 66° F ±9°)	32-104° F (Recommended 66° F ±9°)	
Battery Life	50 hours	50 hours	
Dimensions	ø4.3" x 2.2" H	ø4.3" x 1.7" H	ø5.5" H x 3.2" W x 1.7" D
Weight	2.2 lbs.	2.2 lbs.	.62 lbs.

- Batteries must be ordered separately
- In the case of high precision leveling, we recommend that you check the LEVEL MASTER in advance on a reference level, such as a level block



DIAL INDICATOR STANDS

Articulated stands for the demanding user, offering the highest positioning precision and exact measurements in the μm range.

- High clamping force thanks to a strong internal cam structure of steel components.
- Extremely flexible with 360 degrees freedom of positioning controlled by one progressive clamping star grip
- Ideal design for use in measurement, inspection (quality control) and machining
- Ultra strong magnet holds stand firmly in place
- Each stand is equipped standard with (1) magnet, (2) extension arms, (1) DGH dove-tail adapter and (1) cylindrical gauge adapter ($\varnothing.375"$)

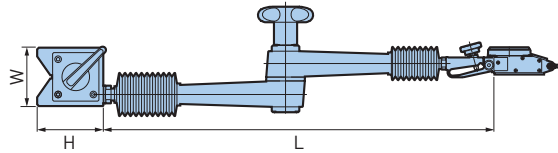

ACCESSORIES



Type MU/F

Catalog Number	Adapter	Arm Extension Capacity L (From Magnet Top)	Magnet Dimensions W x H x D	Load Capacity Approx.
20.510.102	DGH2	13.937 (354mm)	2.087 x 2.362 x 2.677 (53mm x 60mm x 68mm)	200 lbs (90 kg)
20.510.103	DGH3			
20.510.104	DGH4			

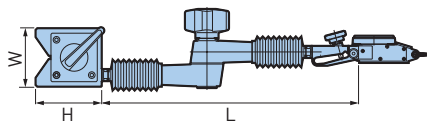

ACCESSORIES



Type SU/F

Catalog Number	Adapter	Arm Extension Capacity L (From Magnet Top)	Magnet Dimensions W x H x D	Load Capacity Approx.
20.520.102	DGH2	9.173 (233mm)	2.087 x 2.362 x 1.417 (53mm x 60mm x 36mm)	110 lbs (50 kg)
20.520.103	DGH3			
20.520.104	DGH4			



TYPE MU/FS

Base with 3-point sliding contact and one flat side for parallel measurement

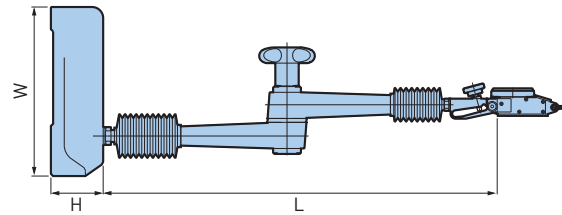

Catalog Number	Adapter	Arm Extension Capacity L [From Magnet Top]	Base Size W x H x D	Weight [Not Including Arm]
20.530.102	DGH2	13.937 (354mm)	5.984 x 1.850 x 5.984 (152mm x 47mm x 152mm)	6.6 lbs. (3 kg)
20.530.103	DGH3			
20.530.104	DGH4			

- 100mm extension arm available to increase work radius (Catalog Number 20.580.513)



TYPE SG

Articulated clamping arm for gluing, welding or soldering, quickly solves all tricky angling problems

Catalog Number	Description	Extension Number	Extension Length
20.540.001	Type SG 3/4 Arm with One Tension Clamps	No. 3	2.953 (75mm)
		No. 4	3.937 (100mm)
20.540.002	Type SG 4/4 Arm with Two Tension Clamps	No. 4	3.937 (100mm)

DIAL GAUGE ADAPTERS

This part forms two opposing legs whose relative position can be fine-adjusted by means of a tensioning screw (DGH3). A special micro model (DGH4) with a fine-adjustment rocker is also available for measurement precision in the µm range. All adapters include a ø.375" cylindrical gauge adapter.

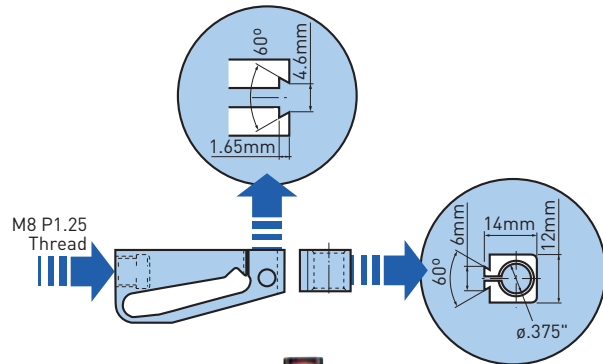

DGH2

Catalog Number
20.580.402

- Basic model (without fine-tuning screw)



DGH3

Catalog Number
20.580.403

- Standard adapter for MU and SU stands



DGH4

Catalog Number
20.580.404

- Precision micro model

CYLINDRICAL GAUGE ADAPTER

Catalog Number	Clamping ø
20.580.501	.250
20.580.502	.375
20.580.511	4mm
20.580.512	8mm



DIAL INDICATOR STANDS—ACCU MINI MINI

- Very rigid, short and sturdy stand with internal steel cam action components
- Clamping of articulating arms by one progressive clamping star grip
- Ultra strong magnet holds stand firmly in place
- Optional models can be supplied with straight shank (ø12 or 20mm) or HSK shank (E25, E32) instead of the magnet to go directly into a machine tool spindle
- Each stand is equipped standard with a dove-tail adapter; cylindrical gauge adapters are optional items

MAGNET TYPE

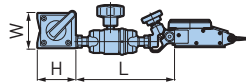

Catalog Number	Magnet Dimensions W x H x D	L
AMM-M	1.260 x 1.378 x 1.378 (32mm x 35mm x 35mm)	3.543

ACCESSORIES

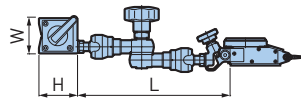

Catalog Number	Magnet Dimensions W x H x D	L
AML-M	1.260 x 1.378 x 1.378 (32mm x 35mm x 35mm)	5.433

ACCESSORIES



STRAIGHT SHANK TYPE

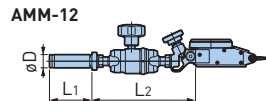

Catalog Number	øD	L1	L2
AMM-12	12mm	1.535	3.701
AMM-20	20mm	1.969	3.622

ACCESSORIES

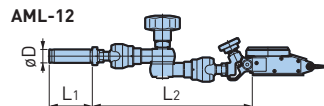
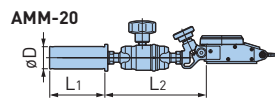

Catalog Number	øD	L1	L2
AML-12	12mm	1.535	5.630
AML-20	20mm	1.969	5.551

ACCESSORIES

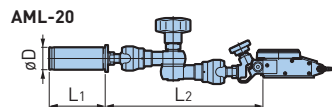

HSK SHANK TYPE

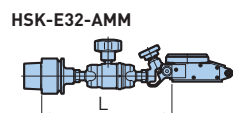
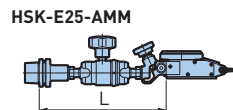

Catalog Number	L
HSK-E25-AMM	4.567
HSK-E32-AMM	4.685

ACCESSORIES





TOOL PRO

The Tool Pro is a unique tool holding device for the assembly and disassembly of tapered V-flange tooling and modular tooling systems. Depressing the large gold button permits the adapter to rotate 360° and lock in 45° increments, allowing convenient access for all operations in one setup. Tightening torque for tool clamping can be applied in a downward motion, rather than horizontally, allowing the Tool Pro to be installed on tool carts. Tools are simply lowered into the tool pot and automatically clamped into place with a spring loaded pin that locates precisely into the V-groove of the tool holder. With the Tool Pro, you reduce damage to your expensive tool holders, shanks and machine spindles while providing a safe working environment for your tool assembly operators—advantages which pay off very quickly!



STEEP TAPER

Taper Size	Catalog Number
30	31.300.001
35	31.300.000
40	31.300.002
45	31.300.003
50	31.300.004
60	31.300.020

HSK TAPER

Taper Size	Catalog Number
32A	31.300.017
40A	31.300.015
50A	31.300.008
63A	31.300.006
100A	31.300.005
125A	31.300.029

• HSK Type E/F, VDI and Polygon taper also available



VARIO

Quick-change system uses one permanently mounted base unit and multiple adapters for different types and sizes of tool shanks.

STEEP TAPER

Taper Size	Catalog Number
30	31.300.110
35	31.300.111
40	31.300.112
45	31.300.113
50	31.300.114

HSK TAPER

Taper Size	Catalog Number
32A	31.300.130
40A	31.300.131
50A	31.300.132
63A	31.300.133
80A	31.300.134
100A	31.300.135

POLYGON TAPER

Taper Size	Catalog Number
C3	31.300.153
C4	31.300.154
C5	31.300.155
C6	31.300.156
C8	31.300.158

- Base unit must be ordered separately (Catalog Number 31.300.100)
- HSK Type E/F and VDI also available



SPIN

Full 360° radial tool rotation, while clamped, permits easy access to large diameter tools making it ideal for changing inserts on large face mills without removing the tool from the drive keys. Tools can be locked at increments of 30° by engaging an index pin. The adapter can also be rotated 360° and locked into any position in increments of 45° to further improve ergonomic handling of any size and length of tool.

STEEP TAPER

Taper Size	Catalog Number
40	31.300.202
50	31.300.204
60	31.300.206

HSK TAPER

Taper Size	Catalog Number
63A	31.300.214
100A	31.300.216
125A	31.300.217

• Polygon taper also available



KOMBIGRIP

Innovative two way clutch and needle roller clamping system assures secure clamping at the tool flange periphery. Safe design eliminates any possibility of damage to the shank taper during the tightening process.

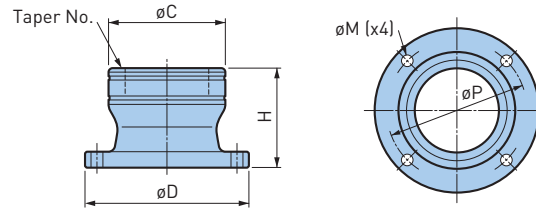

Catalog Number	HSK (Form A/E/F)	BIG CAPTO	øC	øD	H	øP	øM
KG25R	25	—	1.890	3.110	2.559	2.441	.276 (For M6) or UNC 1/4
KG32R	32	C3	2.165	3.346		2.717	
KG40R	40	C4	2.480	3.661	2.756	3.031	
KG50R	50	C5	2.953	4.134		3.504	
KG63R	63	C6	3.465	4.862	2.953	4.154	.354 (For M8) or UNC 5/16
KG80R	80	C8	4.213	5.591	3.543	4.882	
KG100R	100	—	5.000	6.378	3.937	5.669	

- Mounting bolts (4 pcs.) must be ordered separately
- KOMBIGRIP can be used for BIG CAPTO, polygon taper made by others can not be used

CAUTION ⚠

KOMBIGRIP must be securely fixed to a bench with 4 mounting bolts.

ST LOCK

Ideal fixture for the setup of cylindrical shank tool holders. Clamps ø20, 25 & 32mm shanks by replacing the sleeve.



Catalog Number
STL40

- 1 pc. each of ø20, 25 & 32mm sleeves are included
- Mounting bolts (4 pcs.) must be ordered separately

CAUTION ⚠

ST LOCK must be securely fixed to a bench with 4 mounting bolts.

TOOLING MATE

For mounting and removal of Pullstud bolts and tools

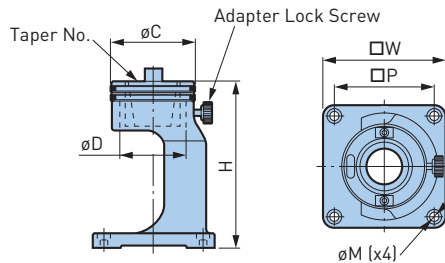

REPLACEABLE ADAPTER

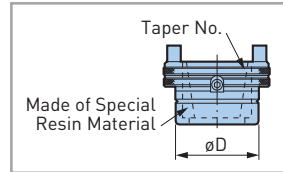

Catalog Number	CV/BT	øC	øD	H	øW	øP	øM	Adapter Model
TMS40-30	30	2.992	2.362	5.906	4.331	3.543	.276 (for M6)	TMA40-30
-40	40							-40
TMS50-40	40	4.134	3.465	7.48	6.299	5.118	.354 (for M8)	TMA50-40
-50	50							-50

- 1 adapter is included
- Adapters can be ordered individually
- Adapter Lock Screw is available as a spare part (Model: RTM0615)
- Mounting bolts (4 pcs.) must be ordered separately

CAUTION

TOOLING MATE must be securely fixed to a bench with 4 mounting bolts.

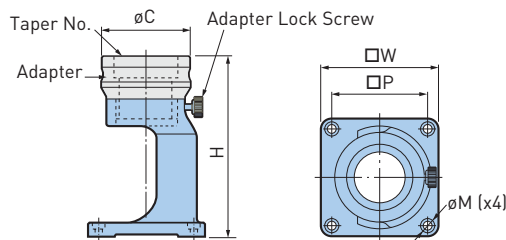

Catalog Number	HSK	BIG CAPTO	øC	H	øW	øP	øM	Adapter Model
TMS40-32R	32	—	2.992	6.496	4.331	3.543	.276 (for M6) or UNC 1/4	TMA40-32R
-40R	40	C4						-40R
-50R	50	C5						-50R
-63R	63	C6						-63R
TMS50-80R	80	C8	4.488	8.465	6.299	5.118	.354 (for M8) or UNC 5/16	TMA50-80R
-100R	100	—	4.882	8.622				-100R

- 1 adapter is included
- Adapters can be ordered individually
- Adapter Lock Screw is available as a spare part (Model: RTM0615)
- Mounting bolts (4 pcs.) must be ordered separately

CAUTION

TOOLING MATE must be securely fixed to a bench with 4 mounting bolts.

TOOLING MATE

For assembling and disassembling cutting tools.

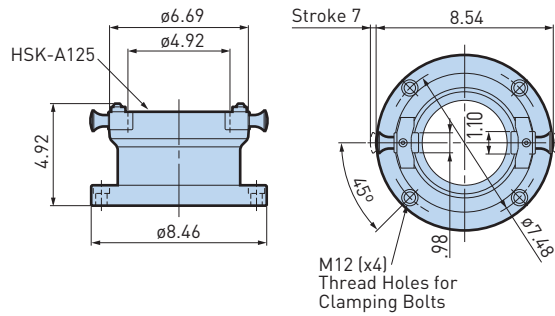

Catalog Number
TMS-HSK-A125

- Dedicated for HSK-A125 interface
- Mounting bolts (4 pcs.) must be ordered separately

CAUTION

TOOLING MATE must be securely fixed to a bench with 4 mounting bolts.

TORQUE FIT

Tooling fixture with tightening torque indicate function.

- Torque values of all BIG KAISER collet chucks are presetted
- Notification by buzzer near the correct torque
- USER-Mode allows setting of desired torque value

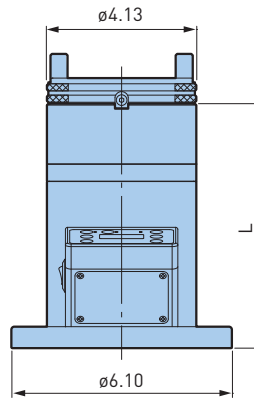

TF-50

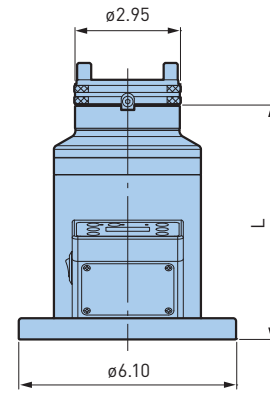

TF-40

Catalog Number	Torque Setting Range	L	Adapter	Input Voltage	Weight (lbs.)
TF-40	4-80 Nm	6.57	TMA40-□	100-240V	17.6
TF-50		6.77	TMA50-□		

- Adapter must be ordered separately

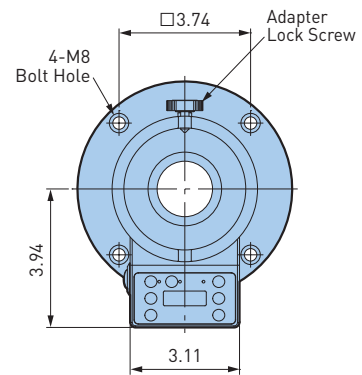

ADAPTERS (OPTIONAL)

For BT/DV

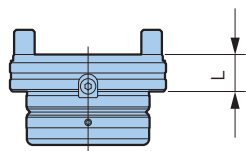

Catalog Number	Body Model	Taper	L	Weight (lbs.)
TMA40-20	TF-40	ISO20	.709	1.8
-30		BT30		1.8
-40		BT/DV40		1.3
TMA50-40	TF-50	BT/DV40		5.1
-50		BT/DV50		2.9

For HSK/BIG CAPTO

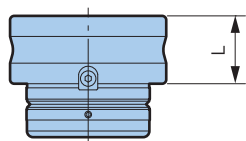

Catalog Number	Body Model	HSK	BIG CAPTO	L	Weight (lbs.)
TMA40-32R	TF-40	32	—	1.30	3.1
-40R		40	C4		2.7
-50R		50	C5	2.0	
-63R		63	C6	1.57	2.0
TMA50-80R	TF-50	80	C8	1.69	5.5
-100R		100	—	1.85	4.0



Q TOOLING CLEANER

For the cleaning of both mating surfaces of BIG-PLUS tool holders, which require absolute cleanliness for optimum performance. Oil and particles on both the taper and flange of 7/24 taper shanks are easily removed.

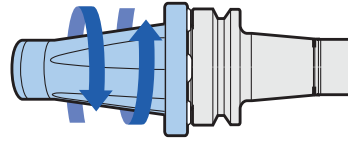

Catalog Number	Shank Size
SCE-30	No. 30
SCE-40	No. 40

HSK EXTERNAL TAPER CLEANER

Reliable and indispensable taper cleaners for the efficient cleaning of HSK tool holder shanks. Cleaning strips positioned at well spaced intervals will remove even large residual particles. Sturdy construction with high oil and grease resistance.



Catalog Number	Description	Taper Size
20.580.041	Taper Cleaner w/ Handy Cap	HSK40
20.580.042	Taper Cleaner w/ Cylindrical Handle	HSK40
20.580.051	Taper Cleaner w/ Handy Cap	HSK50
20.580.052	Taper Cleaner w/ Cylindrical Handle	HSK50
20.580.064	Taper Cleaner w/ Handy Cap	HSK63
20.580.065	Taper Cleaner w/ Cylindrical Handle	HSK63
20.580.081	Taper Cleaner w/ Handy Cap	HSK80
20.580.082	Taper Cleaner w/ Cylindrical Handle	HSK80
20.580.101	Taper Cleaner w/ Handy Cap	HSK100
20.580.102	Taper Cleaner w/ Cylindrical Handle	HSK100



SPINDLE CLEANERS

The unbeatable tool to ensure absolute cleanliness of tapered spindles, which maintains the precision and prolongs the life of your expensive machine tools, cutting tools and tool holders.

- Robust construction with high oil and grease resistance
- Plastic injection molded core with fluted locations for cleaning strips ensures accurate sizing and cleaning efficiency
- Cleaning strips will maintain adhesion to the taper core due to inset location even under scrubbing action
- Cleaning strips positioned at well spaced intervals to remove even large residual particles
- A quality control product



ISO TAPER (WITH PULL STUD RECESS)

Catalog Number	Description	Taper No.
20.580.220	ISO Spindle Cleaner	ISO 20
20.580.230	ISO Spindle Cleaner	ISO 30
20.580.240	ISO Spindle Cleaner	ISO 40
20.580.245	ISO Spindle Cleaner	ISO 45
20.580.250	ISO Spindle Cleaner	ISO 50



MORSE TAPER

Catalog Number	Description	Taper No.
20.580.001	Morse Taper #1 Spindle Cleaner	MT1
20.580.002	Morse Taper #2 Spindle Cleaner	MT2
20.580.003	Morse Taper #3 Spindle Cleaner	MT3
20.580.004	Morse Taper #4 Spindle Cleaner	MT4
20.580.005	Morse Taper #5 Spindle Cleaner	MT5
20.580.006	Morse Taper #6 Spindle Cleaner	MT6



HSK TAPER

Catalog Number	Description	Taper No.
20.580.025	HSK25 Spindle Cleaner	HSK25
20.580.032	HSK32 Spindle Cleaner	HSK32
20.580.040	HSK40 Spindle Cleaner	HSK40
20.580.050	HSK50 Spindle Cleaner	HSK50
20.580.063	HSK63 Spindle Cleaner	HSK63
20.580.080	HSK80 Spindle Cleaner	HSK80
20.580.100	HSK100 Spindle Cleaner	HSK100
20.580.125	HSK125 Spindle Cleaner	HSK125



POLYGON TAPER

Catalog Number	Description	Taper No.
SC-C3	Polygon Taper C3 Spindle Cleaner	C3
SC-C4	Polygon Taper C4 Spindle Cleaner	C4
SC-C5	Polygon Taper C5 Spindle Cleaner	C5
SC-C6	Polygon Taper C6 Spindle Cleaner	C6
SC-C8	Polygon Taper C8 Spindle Cleaner	C8

CHIPFAN

Chip & Coolant Fan!

Fast, safe chip and coolant cleaning without stopping production. Your machine spindle spins the ChipFan blades to provide high volume air cleaning power.

- Coolant through
- 12,000 RPM Max
- Safe, fast method of removing chips and coolant
- Balanced integral design for high speed
- Made from high strength aluminum with anodized coating for long life and durability
- Quieter work environment

MAX
12,000
RPM

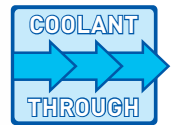

Catalog
Number

ST.750-CF125

DIMENSIONS

Shank: \varnothing .750"

Blade: \varnothing 4.92"

Length: 2.36"

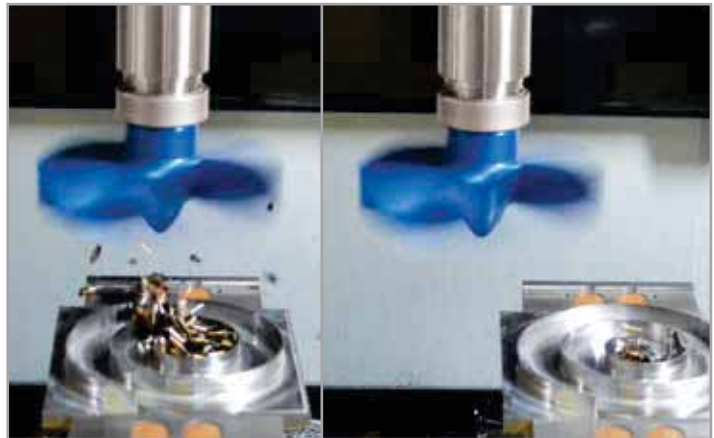

OPERATING INSTRUCTIONS

- Use in enclosed machine centers
- Install into a collet chuck
- Rotation is clockwise
- Optimum feed rate is 120-390 in/min



T-SLOT CLEAN

Improve your work safety environment and efficiency of table cleaning. Save the time required to clean T-Slots packed with chips. Coolant quickly removes heated swarf and helps to prevent thermal displacement of the machine.

- Quick removal of chips from a machine
- Faster table cleaning—a reduction of clean-up time
- Volume control of heated chips—better machining precision
- Three sizes of T-Slot widths are available to fit your machine table

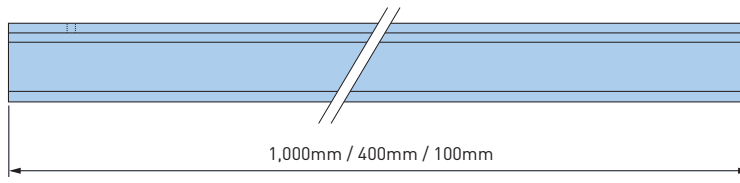
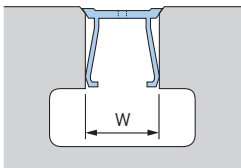
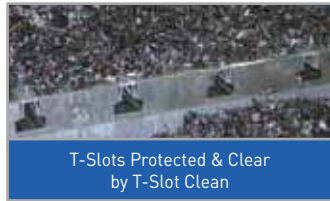

STANDARD SET

Type	Catalog Number	Width W	Width Tol. (H12)	Contents
Metric	TS14-S	14mm	+0.18 0	400mm x 4 pcs.
	TS18-S	18mm	+0.18 0	100mm x 4 pcs.
	TS22-S	22mm	+0.21 0	

- If necessary, cut to the length that you need
- Removal pin is included

COST SAVING SET

Type	Catalog Number	Width W	Width Tol. (H12)	Contents
Metric	TS14-10S	14mm	+0.18 0	TS14-S x 10 sets
	TS18-10S	18mm	+0.18 0	TS18-S x 10 sets
	TS22-10S	22mm	+0.21 0	TS22-S x 10 sets

- Contains 10 Standard Sets for cost savings

LONG SET

Type	Catalog Number	Width W	Width Tol. (H12)	Contents
Metric	TS18-400L-100P	18mm	+0.18 0	400mm x 100 pcs.
	TS22-400L-100P	22mm	+0.21 0	

EXTRA LONG SET

Type	Catalog Number	Width W	Width Tol. (H12)	Contents
Metric	TS18-1000L-10P	18mm	+0.18 0	1,000mm x 10 pcs.
	TS22-1000L-10P	22mm	+0.21 0	

BIG KAISER Precision Tooling Inc.

A Member of the BIG DAISHOWA Group

2600 Huntington Blvd | Hoffman Estates, IL 60192 | P: (224) 770-2999 | F: (224) 770-2997 | bigkaiser@us.bigkaiser.com | www.bigkaiser.com

04/2018 © Copyright 2018 BIG KAISER